

On the Space-Vortex Structure of the Electron

Paramahansa Tewari*

1. Introduction

It was Rene Descartes, the French Mathematician and Philosopher who, perhaps for the first time in a *scientific* sense, assigned a reality to the medium of space as a *property-less* fluid-entity, already known at that time as ether. According to Descartes, large cosmic ether vortices existed throughout the universe. One such vortex carried the planets around the sun, and countless smaller vortices aggregated into different sizes of universal matter, filling the whole of space. He explained gravity by the pressure and impact of ether on bodies; and framed the principles of the inertial tendencies of matter for straight line motion based on the property of the fluidity of a space-substratum filled with ether vortices. The transmission of the then known magnetic forces and the force of gravity between the earth and the planetary bodies found explanations in Cartesian philosophy with *physical contacts* between the interacting entities mediated by the intervening ether. The theory of Descartes at that time was the most convincing natural philosophy and was based on a single *dynamic ether* as the only reality of the universe. The theory remained in acceptance for almost a century after publication of Newton's *Principia*.

Newton's laws of motion took into account the principle of inertia for straight line motion as conceived by Descartes [1], and Galileo's experimental discoveries on freely falling bodies and their motion on inclined planes; but ether was not invoked to explain the properties of mass, inertia (which were introduced in Newton's laws of motion) and the force of gravity. Thus the medium of space, except for its utility as a continuous fluid-substratum for the transmission of light waves, was again made inert and inactive for transmission of forces; and this led to the reintroduction of the principle of "action at a distance." Based on this principle, R. G. Boscovich (1711-87) tried to explain all physical effects and, further, Coulomb and Ampère invoked it in explaining the mutual action of forces between charged bodies and electric currents. In contrast, Faraday's researches led him to the conclusion that electromagnetic induction cannot take place without the intervening medium (field). Faraday introduced the concept of continuously varying electric and magnetic fields, signifying that space is a continuous substratum and "action at a distance" is not the basic principle. He also suggested that an atom could be a structure of

* Former Executive Director, Nuclear Power Corporation; Vinodini Nivas, Gotegali, Karwar-581317, Karnataka, India; email: ptewaril@sancharnet.in

What is the Electron?

edited by Volodimir Simulik (Montreal: Apeiron 2005)

fields of forces—electric, magnetic, and gravitational, existing around its central point. On the existence of ether, Faraday's belief was that it may have its utility in other physical effects, in addition to providing a medium for transmission of light. Based on Faraday's concepts, Maxwell wrote equations using hydrodynamics to model ether, postulating that it was as an incompressible fluid. Helmholtz conceived the ether vortex filament as electric current, and W. Thomson believed [2] that 'the magnetic energy is the kinetic energy of a medium occupying the whole space, and that electric energy is the energy of strain of the same medium.' Atomic structure as a vortex motion was also proposed by Thomson and others, and after the electron's discovery (1897), Larmor concluded that the electron is a structure in the ether and that all matter consisted of electrons only.

Serious problems arose (1905) with the concepts of the vortex structure of atoms/electrons in an incompressible fluid. One problem was that of the dissipation of vortex motion, since the streamlines in a vortex may tend to dilate outward (W. Thomson). Another problem pertained to the difficulty of the transmission of an electromagnetic field in this fluid at the enormous speed of light, for which, if its properties are considered akin to matter, the elasticity should be near to that of steel! While these difficulties were yet to be overcome, Einstein's Theory of Relativity (1905), proposed around the same time, postulated the medium of space as an *empty extension*, which meant no point of space had a velocity-vector (or "velocity field"), thus making the very existence of ether superfluous. The space-vortex structure of the electron, based on this writer's works [3], and described in this paper, provides solutions to both the above problems. The high elasticity required for the fluid-ether, as pointed out above, is avoided by postulating it as a *nonmaterial* and incompressible fluid devoid of any known property of matter, such as mass, density, discreteness, viscosity, elasticity, or compressibility, *etc.* Further, if the properties of "mass" and "charge" of an electron must be derived from the *first principles* proposed by Descartes, Faraday, Maxwell, and Thompson, then a *massless* and *chargeless* fluid that, as a vortex, can form the structure of an electron, must be assumed. That the proof of this assumption—that the universal substratum of space with *nonmaterial** properties has real existence—is provided by deriving the basic properties of the electron (mass, charge, inertia, gravity, locality, *etc.*) from the space† vortex structure, and by explaining its behavior in physical as well as quantitative terms as experimentally observed. The other problem, that of the outward dissipation of the vortex motion, is solved by introducing a *discontinuity* in the energy-distribution at the vortex center, as discussed later.

* "Nonmaterial" signifies a massless, densityless, incompressible, non-viscous and continuous fluid.

† The absolute vacuum with non-material properties is termed as "Space."

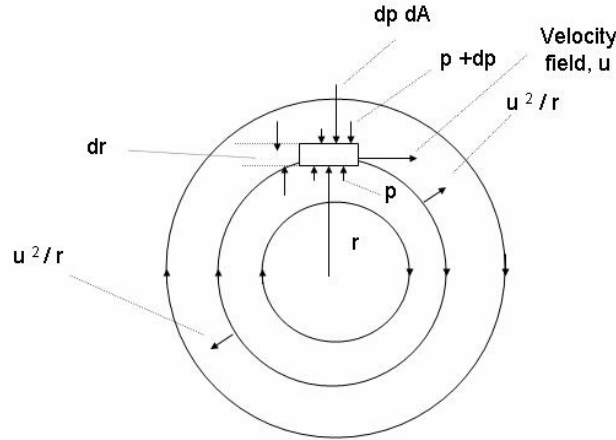

Fig. 1 Irrotational vortex

2. Postulates

1. The medium of space, throughout the universe, is an eternally existing, nonmaterial, continuous, isotropic fluid substratum.
2. The medium of space has a limiting flow speed equal to the speed of light relative to the absolute vacuum, and a limiting angular velocity, when in a state of circulating motion.
3. The medium of universal space is eternal and endowed with motion.

3. Breakdown of fluid space

The creation of an electron requires a breakdown of the flow of the fluid medium of space (hereafter referred to as “space”). Fig. 1 shows an irrotational circular vortex of space with concentric streamlines. Consider an element of space of volume $dAdr$, as shown, on which a tangential velocity field u is acting. If this vortex pertains to a viscous fluid of density ρ , the mass of the element will be: $dm = \rho dAdr$. There will be a pressure differential on the two surfaces of the element as shown. The two equal and opposite forces acting on the element will be: (a) an inwardly directed, radial, net pressure force and (b) a centrifugal force, giving the relation:

$$\begin{aligned} \text{Force} &= \text{net pressure force} = \text{centrifugal force} = dpdA \\ &= dm \times u^2/r = (\rho dA dr)u^2/r, \text{ from which:} \end{aligned}$$

$$\frac{\text{Force}}{dm} = \frac{(dpdA)}{(\rho dAdr)} = \frac{u^2}{r} \tag{1}$$

In an irrotational circular vortex, it can be shown that the velocity of a space-point at distance r from the vortex center is given by:

$$ur = \text{constant} \tag{2}$$

When a vortex of *massless* space is considered, there is neither inward force (on the element) due to the pressure-differential, nor outward centrifugal

force, because the property of mass is common to the origin of both these forces. On a circular streamline, and at each of its points, the velocity field u creates a radial outward acceleration field u^2/r that, acting simultaneously on diametrically opposite points, tends to create a *tearing action* to split open the *continuous* space. If the speed of the space-circulation reaches the limiting speed c , which is the speed of light in the absolute vacuum, and the velocity-field gradient around the center of the vortex becomes the postulated limiting angular rotation ω , the space breaks down, creating a spherical void (Fig. 2), which is defined as a field-less, energy-less and space-less volume of *nothingness* at the vortex center. The radius of the void created follows the relation, as determined by the ratio:

$$\omega = \frac{c}{r_e} \tag{3}$$

4. Stability of the void

Fig. 3 shows a diametrical cross section of the spherical void by the plane Y-Z. The circle C rotating around the Y-axis traces a sphere. The point P_z , at the intersection of C and the Z-axis, will have a tangential velocity c (down the paper) the velocity at which the flow of the fluid-space breaks down. The radius r_e of C, from (2), is determined by the ratio c/ω . Consider a point P at the circle C that has the Y-coordinate, $r_e \sin\theta$: it will have a tangential velocity $\omega r_e \sin\theta$ (down the paper at P) provided P too has the same angular velocity ω similar to P_z . The velocity gradient at P_z is c/r_e , which is also the velocity gradient at P, that is, $\omega r_e \sin\theta / r_e \sin\theta$, or ω .

Thus, though the tangential velocity of space varies from zero at P_y (located at the axis, Fig. 3) to the maximum value c at P_z in the diametrical plane, the velocity gradient for all the in-between points remains constant at ω (Postulate 2). Under these considerations the geometry of the void created at the vor-

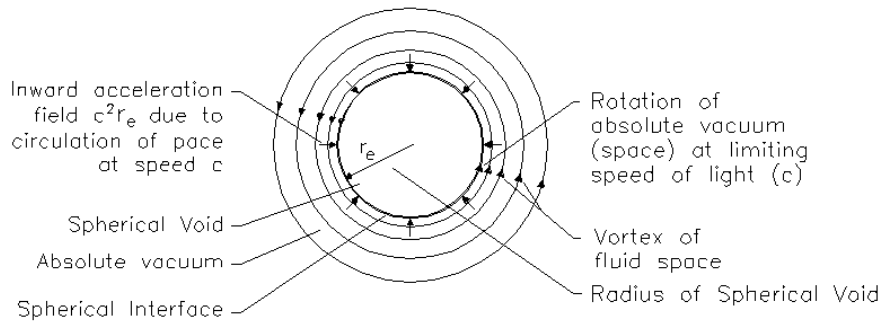

Absolute vacuum possesses non-material properties of incompressibility, zero-viscosity, continuity & mass-lessness of an ideal fluid; fieldless & energyless spherical-void is created due to limiting rotation & breakdown of absolute vacuum.

Fig. 2 Vortex in electron structure

tex center due to the breakdown of the flow of space is concluded to be *spherical*. It is shown below that the void is dynamically stable. The creation of the void reverses the direction of the outward acceleration field* (Eq.1) that created the void; because the void (enclosed within a sphere, here referred as the *interface*) is an empty volume without any “circulating space” or “energy,” it is now at zero potential relative to space surrounding it. Therefore, the acceleration field in Fig. 2 is shown inward. As described above, ω is the limiting *velocity gradient* c/r_e at the point P_z just prior to the creation of the void. At each point of the interface circle cut by a diametrical plane at right angles to the Y-Z plane (Fig. 3), the tangential velocity c produces maximum radial and inward acceleration, c^2/r_e .

The acceleration field at P is $(\omega r_e \sin\theta)^2/r_e \sin\theta$ along $r_e \sin\theta$. Although the interface is constituted of spinning fluid-space, due to the constancy of ω on each of its points, it rotates like a surface of a rigid spherical shell of negligible wall thickness. The stability of the void is due to the following two factors. Consider the circular section of the interface with the diametrical plane (Fig.2). The radial velocity gradient (ω) is c/r_e . If the void shrinks to a smaller radius, the value of ω increases proportionately; which is not possible according to Postulate 2; the void thus expands back to its original size. In the event the void tends to grow to a larger size, the *inward* acceleration field c^2/r_e opposes this increase and any increase in r_e decreases the velocity gradient ω to a lower value, which is no longer sufficient to sustain the void. The sphere of the void is thus reduced to its original size. The other factor is the property of the non-viscosity of space, which maintains the space-vortex eternally, except for its annihilation on meeting a similar vortex with an oppositely oriented velocity field (discussed later). Further, the energy-less-void being a region of zero potential, the inward acceleration field c^2/r_e on the interface prevents dilation of the streamlines, thereby, preventing dissipation of the space-circulation away

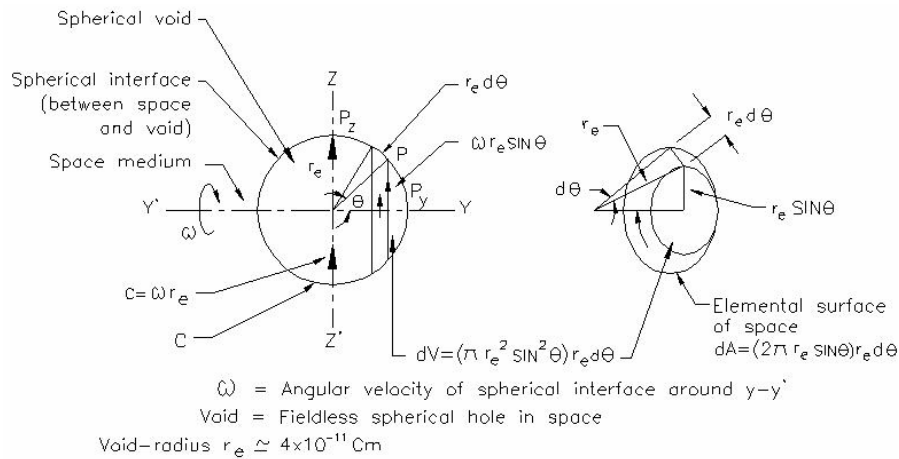

Fig. 3 Velocity Field on Interface

* The acceleration of fluid space at a point is termed “acceleration field.”

from the interface. Thus, the void maintains its dynamic stability—its volume being regulated due to the constancy of ω and, consequently, the constancy of c and r_e , dictated by the absolute* properties of the medium of space.

5. Fundamental particles of matter

If there is only one fundamental particle of matter, it is inconceivable that the universe has different kinds of “spaces” or many structures with varying basic properties. Hence, it is postulated that the most basic property of the universal medium of space is expressed by a single universal constant ω that limits its angular rotation and leads to the creation of a fundamental stable vortex. While the void of a *definite volume* is enclosed within the space-vortex, the vortex itself extends throughout the whole universal-space through its *velocity field*†. The space-vortex structure with a fixed volume of dynamically stable void at its center is defined as the fundamental particle of matter. The properties of “electric charge” and “mass” of the fundamental particle, and the “energy fields” associated with its structure are derived in the following pages.

6. Generation of fields

The space in circulation at speed c within the volume of the spherical void prior to its creation is, qualitatively, the basic state of energy‡. At the instant of the creation of the void, this energy is pushed out from within the void, and distributed in continuous space as continuously varying gravity and electrostatic fields. The fields, so created, emanating from the interface of the fundamental particle, become integral with the whole of universal space. On account of the property of the non-viscosity of space, the void enclosed within the dynamically stable interface at the center of the vortex, and the above fields exist eternally without any loss of strength. The properties of the fundamental particle described above identify it as the electron itself.

7. Unit electric charge

Electric charge is the effect of the space-circulation produced on the interface of a fundamental particle of matter. It is derived as follows. Refer to Fig. 3. Consider an elemental surface on the interface, which has an area: $dA = 2\pi r_e \sin\theta r_e d\theta$. The tangential velocity of space at each point of the elemental surface is $\omega r_e \sin\theta$. The electric charge on the elemental surface is defined from first principles as the *surface integral of the tangential velocity of space on each point of the surface*: $dq = 2\pi r_e \sin\theta r_e d\theta \omega r_e \sin\theta$. Substituting from (2), $\omega r_e = c$, in the above equation: $dq = 2\pi c r_e^2 \sin^2\theta d\theta$. Integrating for the total electric charge q_e , varying θ from 0 to π :

* Properties of space, being non-material in nature, are defined to be absolute; unaffected by various conditions of temperature and pressure as applicable to material media.

† The motion of space leads to the generation of “the velocity field.”

‡ The quantitative definition of energy is given further.

$$q_e = 2\pi cr_e^2 \sin^2 \theta d\theta = \left(\frac{\pi}{4}\right) 4\pi r_e^2 c \quad (4)$$

The surface integral of the tangential space velocity on the interface is defined as the unit of electrical charge of the fundamental particle of matter. The dimensions of electric charge from (4) are: $q_e = L^3/T$. In CGSE system of units:

$$\frac{cm^3}{s} = CGSE - unit \quad (5)$$

Substituting the experimentally determined value of the electric charge of an electron (4.8×10^{-10} CGSE) and the speed of light in absolute vacuum (3×10^{10} cm/s) in (4), and using the relationship (5), the radius of the interface enclosing the void is calculated as $r_e = 4 \times 10^{-11}$ cm. A comparison with the classical electron radius, which in modern textbooks is shown as 2.82×10^{-13} cm, reveals that r_e should be about 142 times smaller. However, the following quote supports the results obtained from (4). “There are several lengths that might aspire to be characteristic of the dimensions of the electron. If we proceed from modern theoretical electrodynamics, which has been established better than any other field theory, the conclusion seems to be that the electron has enormous dimensions, not 10^{-13} cm, as expected from classical physics, but 10^{-11} cm (a hundred times greater!).” [4] This value of the electron radius (10^{-11} cm), and its closeness with the radius of the spherical void derived above from Eq.4, suggests that the “fundamental particle of matter” described above is the electron—already discovered by the close of the 19th century. An electron moving away from an observer (electron axis coinciding with the line of motion) is seen as a positron by another observer whom this electron is approaching. Fig. 4 shows, qualitatively, attractive and repulsive forces between these particles through interaction of their velocity fields, while quantitative relationships follow.

In (a) of Fig. 4, the velocity-field u between particles is increased due to the superposition of the fields. From (2), an increase in u results in a proportionate decrease of r , and hence the particles are brought closer by an attractive force between them. In (b) of Fig. 4, due to the decrease of the velocity field between the particles, r has to increase proportionately, and this causes a repulsive force between similar particles. Quantitative relationships are derived in a later section.

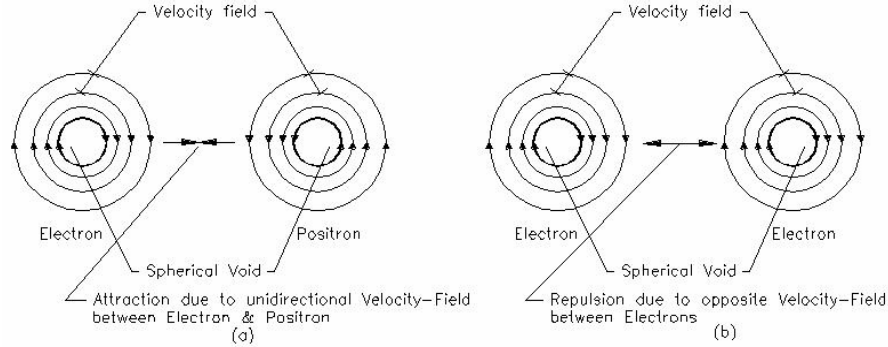

Fig. 4 Attractive & Repulsive Forces due to Velocity Fields

8. Fundamental mass

The property of mass in the fundamental particle of matter (electron) arises due to the breakdown of space circulation at the center of the electron, and consequent creation of a dynamically stable spherical void associated with gravitational as well as electrostatic fields in space. The derivation of the mass of the electron from the vortex structure is as follows. (Refer to Fig. 3.) Consider an element of void volume, dV , within the spherical interface: $dV = (\pi r_e^2 \sin^2 \theta) r_e d\theta = \pi r_e^3 \sin^2 \theta d\theta$. The tangential velocity of space acting at the interface of this element is $\omega r_e \sin \theta$. The physical process of creation of mass, dm , of this element is due to volume dV of the fluid space being pushed out at the time of void creation at the speed $\omega r_e \sin \theta$ tangentially through the interface. The mass of the elemental void volume is defined from *first postulates* as $dm = dV(\omega r_e \sin \theta) = dV(c \sin \theta)$. Substituting the value of dV $dm = (\pi r_e^3 \sin^2 \theta d\theta) \omega r_e \sin \theta = (4\pi/3) r_e^3 c$. Integrating for the total mass m_e , varying θ from 0 to π :

$$m_e = \left(\frac{4\pi}{3} \right) r_e^3 c \quad (6)$$

$$\text{Fundamental mass} = \text{Fundamental void volume} \times c \quad (7)$$

The volume-integral of space-circulation velocity within the void, at the instant of its creation, is the mass of the fundamental unit of matter (electron). A distinction between rest mass and relativistic mass is not made here, as explained. It was earlier shown that the void at the electron center is dynamically stable with radius r_e and space circulation c . This leads to the creation of only one size of stable void. Therefore all the particles of matter, nuclei and atoms will have their masses in exact multiples of electron mass (analyzed further below). The mass of the electron during motion relative to space will remain constant up to speed c because the fluid-space ahead of a moving electron can be displaced up to a maximum speed c only. Thus the volume of the void remains constant; therefore electron mass, which is proportional to the volume of the void (7), also remains constant. The relativistic increase in electron mass at speeds closer to light speed, as experimentally observed, is due to the reaction

of the fluid space against the central interface in electron structure resulting from production of an additional acceleration field, discussed elsewhere [3]. The proportionality of mass to the limiting velocity field c and also to the volume of the central void (6) shows that *mass is not energy*. “*Mass is proportional to energy*” is a more accurate statement.

9. Dimensions and the unit of mass

The dimensions of mass from Eq.6 are: $m_e = L^4/T$. Therefore, in the CGS system of units, the unit of mass is: cm^4/s . With the use of the experimentally determined mass of the electron, the computed mass of a molecule of water, and the known numbers of molecules in one cm^3 of water; a relationship between “ cm^4/s ” and “gram” is approximately determined below. From the charge equation (4), the electron radius is:

$$r_e = \left(\frac{q_e}{\pi^2 c} \right)^{1/2}. \quad (8)$$

The electron charge is experimentally determined as 4.8×10^{-10} CGSE. Expressing CGSE as cm^3/s from (5), $q_e = 4.8 \times 10^{-10} \text{ cm}^3/\text{s}$, and substituting this value of electron charge and the value of c in (8), we obtain

$$r_e = \frac{(4.8 \times 10^{-10} \text{ cm}^3/\text{s})^{1/2}}{(\pi^2 3 \times 10^{10} \text{ cm/s})^{1/2}} = 4 \times 10^{-11} \text{ cm} \quad (9)$$

With the above radius of the interface (void), its volume is $V_e = (4\pi/3)(4 \times 10^{-11} \text{ cm})^3 = 2.67 \times 10^{-31} \text{ cm}^3$. The mass of the electron, experimentally determined, is $9.11 \times 10^{-28} \text{ g}$. Although the concept of density in its structure is not applicable because of the central void, the ratio of the electron mass and the volume of its void will be indicative of the proportionality of the “quantity of mass” within a “unit volume” of void. From above, this ratio, m_e/V_e is $9.11 \times 10^{-28} \text{ g}/2.67 \times 10^{-31} \text{ cm}^3 = 3.42 \times 10^3 \text{ g/cm}^3$. One molecule of water is about $2.88 \times 10^{-23} \text{ g}$. Since the mass of a water molecule has to be an exact multiple of the electron mass, the ratio, m_e/V_e , calculated above for the electron, will also be applicable to the water molecule. From this ratio, the void volume in the water molecule is $V_H = (2.88 \times 10^{-23} \text{ g})/(3.42 \times 10^3 \text{ g/cm}^3) = 8.4 \times 10^{-27} \text{ cm}^3$. One cm^3 of water has 3.34×10^{22} molecules, the void-volume in one cm^3 of water can be calculated as $(3.34 \times 10^{22})(8.4 \times 10^{-27} \text{ cm}^3) = 2.8 \times 10^{-4} \text{ cm}^3$. From the mass-equation (6), and mass and void-volume relationship (7), the equivalent mass of one cm^3 of water due to its void content is $(2.8 \times 10^{-4} \text{ cm}^3)(3 \times 10^{10} \text{ cm/s}) = 8.4 \times 10^6 \text{ cm}^4/\text{s}$. Since the mass of one cm^3 of water is one gram, from above, we have the relationship:

$$\text{gram} = 8.4 \times 10^6 \text{ cm}^4/\text{s} \quad (10)$$

Alternatively, the above relationship can be found through a simpler method as follows. Substituting the values of electron radius r_e from (9) and the experi-

mentally determined mass in mass equation (6), we have $9.11 \times 10^{-28} g = (4\pi/3) (4 \times 10^{-11} \text{ cm})^3 (3 \times 10^{10} \text{ cm/s})$. From which:

$$\text{gram} = 8.8 \times 10^6 \text{ cm}^4/\text{s} \quad (11)$$

The results obtained in (10) and (11) are close; from the average of both:

$$\text{gram} \approx 8.6 \times 10^6 \text{ cm}^4/\text{s} \quad (12)$$

10. Energy in electron structure

Linear and accelerating motion of space are the basic states of energy. The circulation of space, forming the electron's interface and spreading throughout the universal space, is the structural energy of the electron; it is computed as follows. Refer to Fig.3. Consider, within the interface, an elemental "disc of void" of volume $dV = (\pi r_e^2 \sin^2 \theta) r_e d\theta = \pi r_e^3 \sin^2 \theta d\theta$, which is created due to the displacement of space through the interface at the tangential velocity, $\omega r_e \sin \theta$, or, $c \sin \theta$ (since $\omega r_e = c$), at the instant of the electron's creation. The mass of this disc element, as defined in (7) is:

$$dm = dV (c \sin \theta) = (\pi r_e^3 \sin^2 \theta d\theta) c \sin \theta = \pi c r_e^3 \sin^3 \theta d\theta \quad (13)$$

The disc element has an area at the interface equal to $(2\pi r_e \sin \theta) r_e d\theta$, and has an inward radial acceleration field at each point on it such that $a_f = \omega^2 r_e^2 \sin^2 \theta / r_e \sin \theta = c^2 \sin \theta / r_e$. Consider the process opposite to void creation: the case of collapse of the interface to zero radius (as happens during annihilation, which is discussed later), when each point at the interface of the elemental disc will be displaced along the radius $r_e \sin \theta$ with the above inward acceleration field acting on it. The energy released due to collapse of the void-disc-element is defined as $dE = dm \cdot a_f$ (field displacement) $= (\pi c r_e^3 \sin^3 \theta d\theta) (c^2 \sin \theta / r_e) r_e \sin \theta = \pi c^3 r_e^3 \sin^5 \theta d\theta$. Integrating, varying θ from 0 to π , to obtain the total energy released due to the collapse of the spherical void yields the creation energy

$$E = \left(\frac{4}{5}\right) \left(\frac{4\pi r_e^3 c}{3}\right) c^2 = \left(\frac{4}{5}\right) m_e c^2 \quad (14)$$

which is obtained when the mass-equation (6), is used and $(4\pi r_e^3 c/3)$ is substituted for m_e . Here we see an equation discovered by Einstein (and others). However, the physical reason why the speed of light c appears in the mass-energy equation is now explained. It signifies the actual maximum possible space-circulation in the structure of fundamental matter, even when it is stationary relative to the medium of space.

11. Angular momentum of electron vortex

The intrinsic angular momentum of the spinning interface of the electron is found as follows. Refer to Fig. 3. Consider an element of void-volume $dV = \pi r_e^2 \sin^2 \theta r_e d\theta$, which, at the interface, has the tangential velocity of space, $\omega r_e \sin \theta$. Its mass from (6) will be $dm = dV \omega r_e \sin \theta = (\pi r_e^3 \sin^2 \theta d\theta) c \sin \theta = \pi c r_e^3 \sin^3 \theta d\theta$, and angular momentum, $dL = dm (\omega r_e \sin \theta) r_e \sin \theta = (\pi c r_e^3 \sin^3 \theta d\theta)$

$cr_e \sin^2 \theta = \pi c^2 r_e^4 \sin^5 \theta d\theta$. Integrating, varying θ from 0 to π , to obtain the angular momentum for the whole interface, we obtain

$$L = \pi c^2 r_e^4 \sin^5 \theta d\theta = \left(\frac{4}{5}\right) \left[\frac{4\pi}{3} r_e^3 c \right] cr_e = \left(\frac{4}{5}\right) m_e cr_e \quad (15)$$

in which m_e has been substituted for the quantity within the bracket as per the mass-equation (6).

The intrinsic angular momentum of the electron is directly proportional to its mass, radius, and the speed of light.

12. Spin magnetic moment

Refer to Fig.3. Consider an infinitesimal ring-element of charge $dq = dA\omega r_e \sin \theta$. The Magnetic moment due to this charge element is defined as $d\mu = dq(\omega r_e \sin \theta) r_e \sin \theta = (2\pi r_e \sin \theta r_e d\theta)(\omega r_e \sin \theta)(\omega r_e \sin \theta) r_e \sin \theta = 2\pi c^2 r_e^3 \sin^4 \theta d\theta$. Integrating, varying θ from 0 to π , to obtain total magnetic moment of the electron, we obtain

$$\mu = (2\pi c^2 r_e^3) \left(\frac{3\pi}{8}\right) = \left(\frac{3}{4}\right) \left(\frac{\pi}{4}\right) (4\pi r_e^2 c) cr_e = \left(\frac{3}{4}\right) q_e cr_e \quad (16)$$

The magnetic moment of electron is directly proportional to its charge, radius, and speed of light.

13. Electrostatic field energy

An expression for the electrostatic field of the electron at a point in space is derived below from the vortex structure of the electron. Refer to Fig. 5. Consider a sphere of radius r , cut by a plane parallel to the X-Z plane containing a circle C of radius $p_1 y_1$. The radius r (op_1) passes through the interface of the electron at point p , and meets C at p_1 . In the diametrical plane X-Z of the interface (void), the point z at the interface will have a tangential velocity of space ωr_e , that is c (down the paper); the tangential velocity of space at the point z_1 (in the plane X-Z) down the paper, from (2), will be cr_e/r . The velocity of space u_2 , at p , tangential to the circle C_1 , is $\omega r_e \sin \theta$, whereas, at p_1 tangential to the circle C, the velocity of space from (2) is $u_1 = (\omega r_e \sin \theta) r_e \sin \theta / r \sin \theta = cr_e \sin \theta / r$. The inward acceleration field at p_1 , along $p_1 y_1$ is:

$$a_f = \frac{u_1^2}{r \sin \theta} = \frac{(cr_e \sin \theta / r)^2}{r \sin \theta} = \frac{c^2 r_e^2 \sin \theta}{r^3} \quad (17)$$

The component of a_f along the radius op_1 from (17) is $a_r = a_f \sin \theta = c^2 r_e^2 \sin^2 \theta / r^3$. The electric field E at p_1 along the radius op_1 is defined to have the following relationship with the radial space acceleration field a_r derived above:

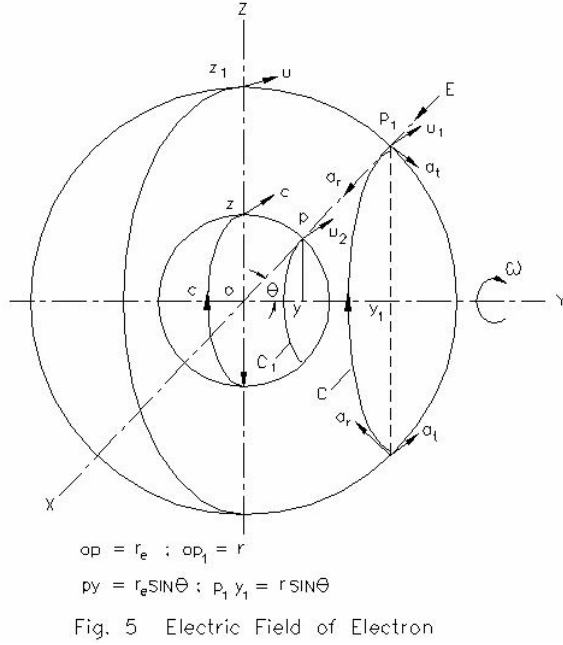

$$\frac{dE}{dr} = a_r = \frac{c^2 r_e^2 \sin^2 \theta}{r^3} \text{ from which } E = \frac{-c^2 r_e^2 \sin^2 \theta}{2r^2} \quad (18)$$

which is an *inward* field created by the electron (also by a positron, if the same is considered) with the minimum value of r equal to r_e , because the void is *field-less*.

The magnitude of E at the interface, along the Y-axis, for $\theta=0$, is zero; and in the transverse plane (E_{tr}) for $\theta=\pi/2$, at the point z_1 distant r from the origin is

$$E_{tr} = \frac{-c^2 r_e^2}{2r^2} \quad (19)$$

The maximum value of E is at the interface in the transverse plane X-Z for $\theta=\pi/2$, and $r=r_e$

$$E_{\max} = \frac{-c^2}{2} \quad (20)$$

The electric potential ϕ at z_1 from (19) is given by $d\phi/dr = E_{tr}$, from which, $d\phi = E_{tr} dr = (c^2 r_e^2 / 2r^2) dr$, and $\phi = -c^2 r_e^2 / 2r$. In an irrotational vortex, from (2), $cr_e = ur$. Substituting this in the above equation, we have,

$$\phi = \frac{-cr_e(ur)}{2r} = \frac{cru}{2} \quad (21)$$

From (21) it is seen that in a space vortex, the velocity field u , is the most fundamental field in the universe, which creates the electrostatic potential. Attraction

tion between an electron and a positron (Fig.4a) can be calculated by using Coulomb's equation for interaction between charges with the concept of the electric field derived above, and also explained through superposition of velocity fields as stated earlier. Coulomb's law, which was experimentally determined, can be derived from (19) as follows. Multiplying and dividing the right-hand side of (19) by $(\pi/4)4\pi$ and rearranging terms: $E_r = -c^2 r_e^2 (\pi/4)4\pi/2r^2$ $(\pi/4)4\pi = -2c[4\pi r_e^2 c \pi/4]/\pi 4\pi r^2$. Replacing the quantity in the bracket by q_e from the charge-equation (4), we have,

$$E_r = \frac{-2/\pi(c/4\pi)q_e}{r^2} \quad (22)$$

The above equation shows that the electric field, that is, "force per unit charge," is directly proportional to the charge, and inversely proportional to the square of the distance from the charge, in agreement with Coulomb's law, and for spherically symmetric charge distribution is

$$E = \frac{(1/4\pi\epsilon_0)q_e}{r^2} \quad (23)$$

14. Dielectric constant, permeability constant, Gauss' law

Using equations (20, 23), and charge equation (4), we derive the dielectric constant of the vacuum [3] as

$$\epsilon_0 = \frac{\pi}{2c} \quad (24)$$

The vacuum dielectric constant is inversely proportional to the speed of light. A check can be made for the above equation by substituting $\pi/2c$ in (23) in place of ϵ_0 , yielding $E = 1/4\pi(\pi/2c)q_e/r^2 = (c/2\pi^2)q_e/r^2$.

Expressing q_e in CGSE and inserting the value of c , $E = [(3 \times 10^{10} \text{ cm/s})/2 \times (3.14)^2]4.8 \times 10^{-10} \text{ CGSE}/r^2 = (0.73)\text{CGSE}/r^2$. Two CGSE unit charges, located 1 cm apart, require that the above computed coefficient, 0.73, should be 1; the difference is negligible.

From Maxwell's equation it follows that $c = 1/(\mu_0\epsilon_0)^{1/2}$, where μ_0 is the permeability constant of the vacuum. (From this basic relationship it is possible to predict that light is an electromagnetic effect). When ϵ_0 is expressed in terms of c as derived in (24), the above equation becomes $c = 1/(\mu_0\pi/2c)^{1/2}$; from which we have:

$$\mu_0 = \frac{2}{\pi c} \quad (25)$$

It is seen that like the dielectric constant, the *permeability constant of the vacuum is also inversely proportional to the speed of light.*

Using equation (18) for the electric field, charge equation (4), and relationship (24) for the dielectric constant, we derive Gauss' law [3] as $\Phi_E = (-2/3)q_e\epsilon_0$.

15. Electrostatic energy in electron vortex

The electrostatic energy U in the velocity field of the electron vortex is calculated [3] from the electric field(18), the dielectric constant (24), and mass equation (6), as

$$U = \left(\frac{\pi}{10} \right) m_e c^2 \quad (26)$$

In the integral to compute the above energy U , the lower limit of the radius from the electron center is the interface radius r_e of the electron, not zero, as is the case with a point-charge, which would lead to infinite energy in its electrostatic field. The electrostatic energy (26) is less than the total electron creation energy in space derived in the mass-energy equation (14). The difference (about $(1/2)m_e c^2$, given below) should appear as the electron's gravitational energy in space.

16. Gravitation

Gravitational effects arise from the very structure of the electron. As a result of the creation of the spherical void at the electron center due to the limiting speed of space-circulation, universal space is gravitationally energized (Fig.6) through the transmission of gravitational potential, a process starting from the interface of the electron and proceeding outwards at speed c , the limiting speed for transmission of fields/potentials in space. The energy used to create each electron is retained in space as gravitational/electrostatic potential, there being no reduction in the overall content of the universal energy due to the creation of electrons. The creation of electron voids requires energy (14) of magnitude $(4/5)m_e c^2$, out of which, from (27), $(\pi/10)m_e c^2$ is distributed in space as electrostatic energy, whereas, the remainder, about $(1/2)m_e c^2$, stays in space as gravitational potential. As shown in the figure, the gravitational field, g , of the electron is derived [3] as

$$g = \frac{(k/4\pi c) m_e}{r^2} \quad (27)$$

in which k is a "constant of proportionality" with dimensions $1/T^2$, so that the dimensions of g from (27) are: L/T^2 . Since the electron is identified as the fundamental particle of matter, (27) is the equation of the gravity field applicable to all nuclei, atoms and matter in general. A gravitational constant for an atom of average atomic mass has been derived [3] from (27).

17. The annihilation of electrons and positrons—the fundamental nature of light

With the discovery of the positron (1932) a new phenomenon of the annihilation of electrons and positrons was observed. During this process, the spherical interfaces of the particles, under strong electrical attraction, are brought together and at a very close range, the particles superimpose on each other; thus stopping the oppositely directed space-circulations around their interfaces which leads to a collapse of their central voids. In this process mass vanishes and light is produced. It is evident that the *void interiors* within the interfaces of the electron and positron, being energy-less, cannot *emit* any kind of energy (such as photons). The energy (velocity and acceleration fields) in the vortex structure of these particles pervades the whole of universal space both before annihilation; and following annihilation. Following the annihilation, the process in which the electromagnetic and gravitational potentials are reduced to zero, a single shell of light, seen as a pulse, initiates from the superimposed interfaces. (Fig.7).

When the interfaces of the particles superimpose, there is only one spherical-void common to both particles; space flows radially at its maximum speed c into the void (Fig.7). The duration of collapse is $\Delta t = r_e/c$. During this period, a shell of radial width, $\Delta t c$, that is, $(r_e/c)c = r_e$, is formed, and transmitted outward at speed c relative to space. Within the wavelength, the space points undergo acceleration: $c/(r_e/c)$, which is c^2/r_e . (For light produced due to thermal radiation, acceleration of points within the wavelength is c^2/λ , where λ is the wavelength [3]) The transmission of the shell is a process that de-energizes the space medium, erasing for all the time the gravitational and electrostatic potentials that were created at the time of the creation of the now non-existent electron and positron. *The spherical shell produced due to the dying of potentials, a process of de-energizing of the space substratum due to electron / positron annihilation, is the fundamental phenomenon known as light.*

The wavelength of the annihilation light (Fig.7) is equal to the electron radius. *The concept of frequency is not applicable to this light, with a single shell.* In the event several annihilations take place at a point one after another *without absolutely any time gap between the successive annihilations*, the frequency can be defined as the number of shells formed in unit time. Also, if the time for the formation of a *single shell* is Δt , then frequency f can be defined as: $f = 1/\Delta t$. This mathematical operation does not mean that the single-shell-

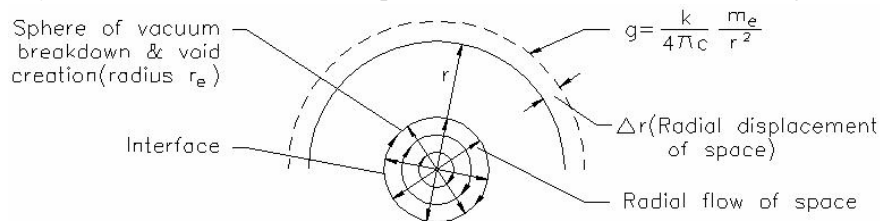

Fig. 6 Gravitation

light has the property of frequency in the conventional definition of frequency ($c = \lambda f$). The interrelationship between light and gravity and the derivation of the gravitational and Planck constants have been analyzed elsewhere [3].

18. Magnetic fields

The electron has an axis of rotation at right angles to the diametrical plane of its space vortex (Figs. 2, 3). The pattern of the circular magnetic field distribution observed around a current carrying conductor, though of a representative nature, gives an indication that the natural motion of an electron in an electric current flowing in a conductor is along the axis of its vortex rotation, because the streamlines of the fluid-space in the electron vortex are concentric with the electron axis (Fig.2). Given the similarity between the velocity-field in the space vortex of an electron and the magnetic field produced in a conductor due to its motion relative to space, the fundamental nature of the magnetic field associated with a moving electron can be determined [3]. In Fig. 8 an electron is shown moving linearly at uniform velocity v relative to space. It is seen that the direction of the maximum velocity field c at the interface is opposite to the magnetic field produced due to the electron's motion. The analysis [3] shows that the magnetic field is an effect produced due to the reaction from the fluid space against the velocity field in the vortex on account of the electron's motion relative to space. It has also been shown that a point on a circle of radius r concentric with the axis (Fig 8) in the electron vortex will have magnetic field; $B = vr_e/r$; which shows that B falls inversely to r .

Given this relationship, the charge equation (4) and relationship (25), Ampere's law can be derived [3]. Due to the opposite direction of the magnetic field vector compared to the spin-direction in the electron vortex (Fig. 8), two electrons in parallel motion in the same direction will magnetically attract, while, at the closest range (about 10^{-10} cm) they will electrically repel.

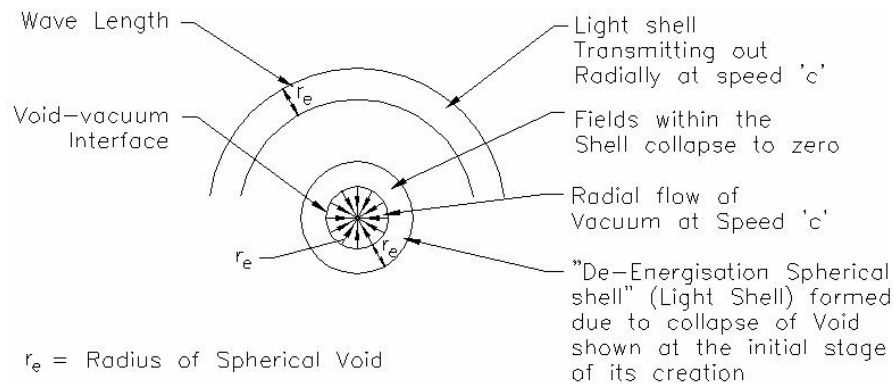

Fig. 7

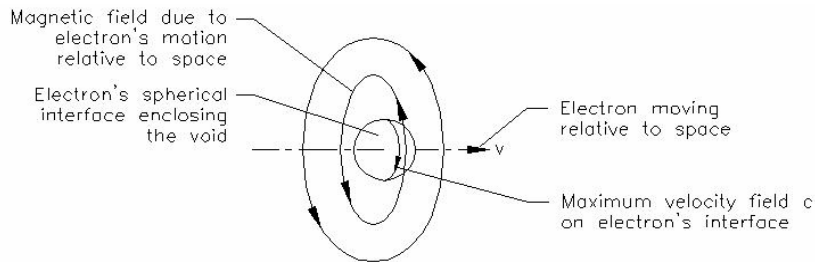

Fig. 8 Magnetic field of electron in motion relative to space

19. Atomic Structure

The limitation on the creation of only one size of stable-void in the space vortex that produces stable fundamental mass and charge as basic units very much simplifies the theory of atomic structure with the electron as the fundamental particle of the atomic nucleus. It follows that all stable particles will possess mass in exact multiples of electron mass—there being no difference between rest-mass and relativistic mass. Further, no *stable* particle with mass less than electron mass can ever be found naturally or created through artificial means in laboratory. *Unstable* particles with masses different from the electron mass are presumed to be some intermediate stage in the formation of stable particles like neutrons. Stable particles such as protons and alpha particles are enclosed in space-vortices that have the property of charge.

The *unstable* particles, with charge, will also be enclosed within space vortices of varying strengths for the duration of their lifetime. A neutral particle, like a neutron, does not have an overall space vortex around it and hence, without an electric charge, it remains neutral. All stable particles, neutral or charged, will have spin-axes of rotation. The charge of a particle, from the charge-equation, will be the surface integral of the velocity field on its surface. An electron and a positron at closest possible range (about 10^{-10} cm) will undergo annihilation under electrical attraction, unless, the particles are translating *relative to space* and, thereby, producing a magnetic force of repulsion between them (Sec. 14).

Just as an electron is subjected to an “inward acceleration field” on its interface, all charged particles and nuclei, with space-circulation around them, will have an “inward acceleration field” tending to crush the particles. This inward force arises due to the existence of a void at the electron center, the vortex structure, and space-circulation around charged particles and the nuclei of atoms. Based on the above guiding principles, arising from the space-vortex structure of the electron, its observed properties and behavior, the possible structures of nuclear particles are described below.

19.1 The primary unit

In Fig.9 an assembly of two electrons and two positrons is shown. The velocity fields between the particles are unidirectional, but in the region external to the

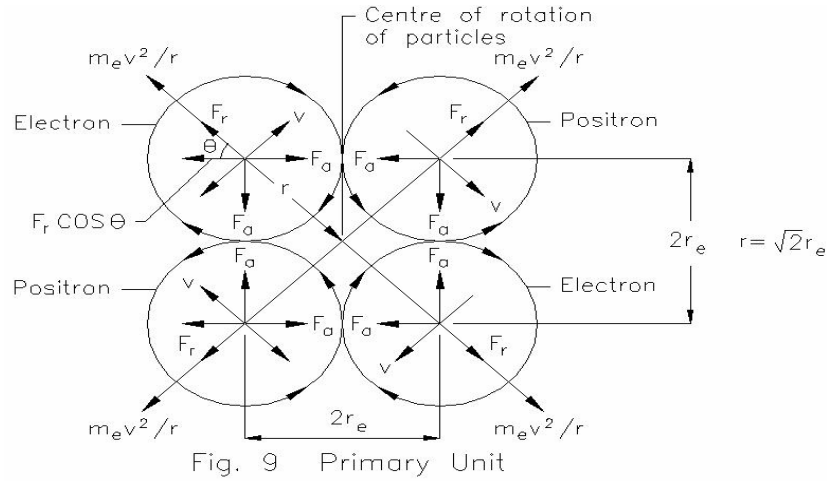

Fig. 9 Primary Unit

assembly (not shown in the figure), will be in opposition. Therefore, this assembly (designated “primary unit”) will show overall electrical neutrality. The particles repel diagonally (F_r) due to similar charges, whereas, there is attraction between the adjacent particles (F_a) due to dissimilar charges. In addition, if the particles are also spinning around the center of their assembly, there will be a radial force, $m_e v^2 / r$, which will reinforce the diagonal electrostatic repulsive force F_r . If the component force, $F_r \cos \theta$, balances the attractive force F_a , the primary unit will be stable. Approximate computation [3] of the forces in the primary unit shows that *if the assembly rotates at speed c* , repulsive and attractive structural forces are nearly equal.

19.2 Neutrons

If a primary-unit is enclosed within a space vortex, it will be electrically charged and will be subjected to an inward acceleration field on the surface, thus making it a stable building block of matter. A neutron core can be assembled with several such charged units, in a similar pattern as electrons and positrons assemble into a neutral primary-unit. For a spherical assembly of equal numbers of electrons and positrons with a total of n particles, the radius is $r = (n)^{1/3} r_e$. For a neutron, which should have 919 electrons and an equal number of positrons for overall neutrality with the superposition of their velocity fields, the radius is:

$$r_n = (1838)^{1/3} r_e \approx 12r_e \quad (28)$$

Calculations [3] show that electrical repulsive forces in this assembly are about two times less than the electrical attractive forces between the adjacent primary units. The neutron should therefore be a stable particle, but for the fact that it is known to have angular momentum; which signifies that it undergoes rotation.

It is found that a neutron rotating around its axis at speed c at the periphery (which will account for its maximum possible angular momentum), will not be stable; and therefore, its constituents (electron/positron) may be dislodged

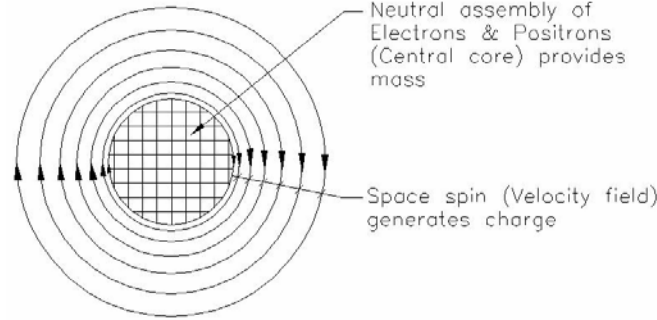

Fig. 10 Proton

due to outward centrifugal force, and emitted outward. This explains beta-decay, and shows why a neutron has a short half-life of only about 15 minutes.

19.3 Protons and the hydrogen atom

The proton structure contains a neutron enclosed within a space-vortex (Fig. 10), which accounts for the charge of the proton and in addition, creates an inward acceleration field. In the proton structure, the inward acceleration field on its core (neutron's surface) makes the proton an ultra stable particle. Like the electron, the proton's maximum velocity field is confined within the diametrical plane at right angles to the axis of rotation. From (2), for an irrotational vortex, ur is constant. Therefore, the maximum tangential velocity (u_p) of space at the surface of the proton's core in the diametrical plane transverse to the axis of rotation is found from $u_p r_n = cr_e$, where c is the tangential velocity at the interface of electron of radius r_e . From this we obtain

$$u_p = \frac{cr_e}{r_n} = \frac{cr_e}{12r_e} = \frac{c}{12} \quad (29)$$

The electric charge of the proton due to u_p is computed from the relationship similar to the charge equation (4) as

$$q_p = \left(\frac{\pi}{4}\right) 4\pi r_n^2 u_p = \left(\frac{\pi}{4}\right) 4\pi (12r_e)^2 \frac{c}{12} = 12\pi^2 r_e^2 c \quad (30)$$

which is 12 times the electron charge. A hydrogen atom (Fig.11), which has a proton and an electron, is neutral because of cancellation of the magnetic moments as shown below. The orbiting electron is located at a distance that reduces its velocity field to the same value as at the surface of the proton core $cr_e = (c/12)r$, where r is the distance of the electron center from the surface of the neutron; from this we have $r = 12r_e$, which is equal to r_n from (28). Thus, the radius of the electron orbit is $2r_n$. The magnetic moment of the orbital electron is due to its intrinsic spin (16) and its orbital velocity v_{orb} . The total of the magnetic moments is

$$\mu_e = \frac{(3/4)q_e cr_e + q_e V_{orb} (12r_e + 12r_e)}{2} = q_e r_e \left[\left(\frac{3c}{4} \right) + 12V_{orb} \right] \quad (31)$$

The intrinsic magnetic moment of the proton, from an expression similar to the electron (16) is $\mu_p = (3/4)[q_p(c/12)12r_e]$. Substituting, $q_p = 12q_e$, from (30), we have

$$\mu_p = (3/4)[12q_e (c/12)12r_e] = 9q_e cr_e \quad (32)$$

Equating the magnetic moment of the electron (31) to the magnetic moment of the proton (32) in order to achieve an electrically neutral hydrogen atom, we obtain $q_e r_e [(3c/4) + 12v_{orb}] = 9q_e cr_e$, which gives: $v_{orb} = 0.69c$. In the hydrogen atom, the radius of the electron orbit is $24r_e$, about 10^{-9} cm, and its orbital velocity is 69% of light speed. With this high rotational speed, the orbital electron completes one orbit in a time of $(2\pi)10^{-9}$ cm / $(0.69)3 \times 10^{10}$ cm/s, that is, 3×10^{-19} s, providing an outer shield to the hydrogen atom with its spinning interface that can not be penetrated.

The binding force provided by the velocity fields of the oppositely spinning vortices of the orbital electron and proton maintain the assembly with no energy loss from the system since the vortices are formed in non-viscous space.

The Hydrogen nucleus (a neutron within a proton vortex) has an inward acceleration field of strength $(c/12)^2/12r_e$, or $(1/12)^3 c^2/r_e$. This inward field, which is $(1/12)^3$ times less than the maximum possible field (c^2/r_e) on the electron interface, makes it a highly stable particle, as stated before. In a similar manner, two protons and two anti-protons (with opposite direction relative to the proton vortex), enclosed within an overall space-vortex, can assemble an alpha particle, a helium nucleus. When several alpha particles are assembled, with four in each unit (similar to the assembly of primary units in the neutron

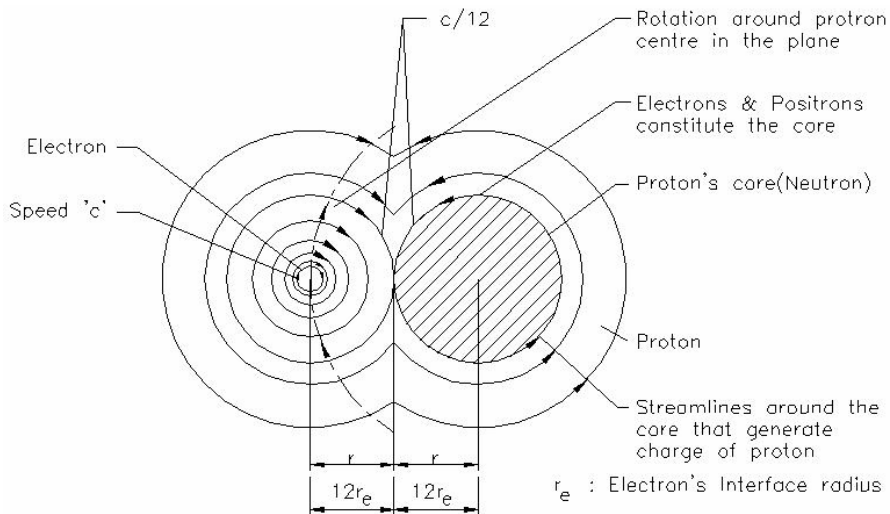

Fig. 11 Hydrogen Atom

structure), and enclosed within an outer vortex, all nuclei of atomic mass higher than helium can be built. This process requires that nuclei should have equal numbers of neutrons and protons, which, however, is not the case. For example, the ratio of neutrons to protons in the Uranium nucleus is 1.586. This leads to the conclusion that, in addition to the alpha particles, neutrons are also *independently* present, as required by the atomic masses of the nuclei. The emission of alpha particles from radioactive nuclei provides solid proof of their existence within nuclei in an *independent* condition. The presence of electrons and positrons in nuclei is confirmed by beta particle radiation. For simplicity in the analysis of the stability of nuclear structure, we can assume that protons and neutrons exist independently in a dynamic assembly, and each proton exerts a repulsive force on the rest of the protons in the nucleus which is enclosed within an outer space-vortex [3]. The space-vortex enclosing the nucleus creates an inward field acting on the nucleus and it has a maximum value in the diametrical plane at right angles to the axis of rotation of the nucleus; given by u_n^2/r_n , where u_n is the tangential velocity of space at the nuclear surface in the diametrical plane, transverse to the axis of rotation, and r_n is the nuclear radius. Since from (2), u_n varies inversely as r_n , the *inward* acceleration field on the nucleus falls inversely as the cube of r_n . The *outward* electrical repulsive forces within the nucleus trying to disrupt its structure (due to the presence of protons) fall inversely as the square of r_n . Since the inward acceleration field falls faster, nuclei with more protons and a larger radius become radioactive. By equating the outward electrical force in the nucleus with the inward force it is concluded [3] that *stable* nuclei with protons more than 100 cannot exist in nature.

20. Interaction of orbital electrons in an atom with a wave-pulse (shell) of light

With the nuclear structure described above, the nuclear radius of an average atom (120 times proton mass) is computed [3] as $r_n = 2.37 \times 10^{-9}$ cm. The maximum velocity field at the nuclear surface from (2) is $u_n = 5 \times 10^8$ cm/s. In the atomic vortex around the nucleus, this velocity field will fall off inversely with distance to $v = 1.2 \times 10^8$ cm/s at a radial distance of 10^{-8} cm, which is assumed to be the orbital radius of the outermost electron. The orbital electron in the space vortex will be subjected to an inward acceleration field $a_f = v^2/\text{orbital radius} = (1.2 \times 10^8 \text{ cm/s})^2/10^{-8} \text{ cm} = 1.44 \times 10^{24} \text{ cm/s}^2$. Suppose a light shell of wavelength λ , and an acceleration-field a_l , across the wavelength (directed towards the source) meet the orbiting electron at an instant when both the above acceleration fields are in line. Since the direction of a_l is opposite to that of a_f , the two acceleration fields will nullify and the electron will be released from the vortex if $a_l = a_f$. As stated earlier, $a_l = c^2/\lambda$. Substituting the values of the acceleration fields, we have $(3 \times 10^{10} \text{ cm/s})^2/\lambda = 1.44 \times 10^{24} \text{ cm/s}^2$, from which $\lambda = 6.25 \times 10^{-4}$ cm, corresponding to a frequency of 0.48×10^{14} cycles/s. (For metallic sodium, the threshold frequency for the photoelectric effect is about

$5 \times 10^{14} \text{ sec}^{-1}$). The orbital electron, moving with velocity v , will be released with the kinetic energy that it *already* possesses, $E = (1/2)m_e v^2 = (0.5 \times 10^{-28} \text{ gm}) (1.2 \times 10^8 \text{ cm/s})^2 = 7.2 \times 10^{-11} \text{ ergs}$. Experiments show that the kinetic energy of photoelectrons is about $8 \times 10^{-11} \text{ ergs}$, very close to the above computed value! Considering the approximate nature of the assumption made as to the electron's orbital radius and computation of the nuclear radius for an atom of average mass, better results could not be expected. It is concluded that light (photons) does not impart energy to the photoelectron for its release. The kinetic energy of a released photoelectron is its own energy of motion in the space vortex of an atom. Light simply disturbs the stability of the forces under which an electron is stable in its orbit.

Conclusion

The medium of space in dynamic states creates matter and its associated fields. The properties of mass and charge, the gravitational, electromagnetic, and nuclear fields are produced from the most fundamental field, the velocity field, and unified in the electron structure. The property of inertia arises [3] due to the reaction from space on the central void in the electron's vortex structure. The velocity of light relative to the space-medium is a common factor in all the *basic* universal constants so far experimentally determined. The electron is the fundamental particle of matter.

Acknowledgements

The author thanks his friends and colleagues Toby Grotz and James Sheppard for their editing and suggestions during the preparation of this paper.

References

1. Alexandre Koyre & I. Bernard Cohen, *Isaac Newton's Principia*, page: 28
2. Sir Edmund Whittaker, *A History of the Theories of Ether and Electricity*, p 317
3. Paramahansa Tewari, *Universal Principles of Space and Matter—a Call for Conceptual Reorientation*, (2002)
4. George Yankovsky, *Philosophical Problems of Elementary Particles Physics*, Progress Publishers, Moscow (1968).