

I.C.I. LTD
PHARMACEUTICALS DIVISION
LIBRARY

Call No: H537A

FA

U.D.C.

H537

Received:

Location:

MERESIDE LIBRARY



22501996150

537

Rolls Appleyard.
with best wishes from
W. S. Tucker.

12.

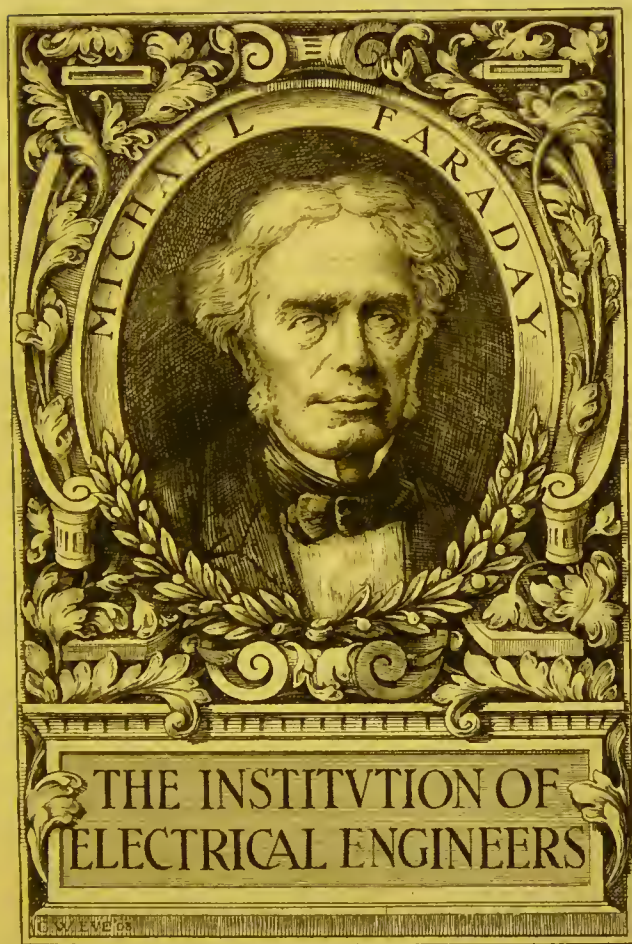

EXPERIMENTAL RESEARCHES

IN

ELECTRICITY.

BY

MICHAEL FARADAY, D.C.L., F.R.S.

FULLERIAN PROFESSOR OF CHEMISTRY IN THE ROYAL INSTITUTION.
CORRESPONDING MEMBER, ETC., OF THE ROYAL AND IMPERIAL ACADEMIES OF
SCIENCE OF PARIS, PETERSBURGH, FLORENCE, COPENHAGEN, BERLIN,
GOTTINGEN, MODENA, STOCKHOLM, PALERMO, ETC. ETC.

Reprinted from the PHILOSOPHICAL TRANSACTIONS of 1831—1838.

VOLUME I.

LONDON :
BERNARD QUARITCH, 15 PICCADILLY.

1839.

[*Facsimile reprint.*]

[1878]

ALERE FLAMMAM.



PRINTED BY TAYLOR AND FRANCIS,
RED LION COURT, FLEET STREET.

WELLCOME INSTITUTE LIBRARY	
Coll.	welM0m5c
Call No.	Q 400 1839 F22e

P R E F A C E.

I HAVE been induced by various circumstances to collect in One Volume the Fourteen Series of Experimental Researches in Electricity, which have appeared in the Philosophical Transactions during the last seven years : the chief reason has been the desire to supply at a moderate price the whole of these papers, with an Index, to those who may desire to have them.

The readers of the volume will, I hope, do me the justice to remember that it was not written as a *whole*, but in parts ; the earlier portions rarely having any known relation at the time to those which might follow. If I had rewritten the work, I perhaps might have considerably varied the form, but should not have altered much of the real matter : it would not, however, then have been considered a faithful reprint or statement of the course and results of the whole investigation, which only I desired to supply.

I may be allowed to express my great satisfaction at finding, that the different parts, written at intervals during seven years, harmonize so well as they do. There would have been nothing particular in this, if the parts had related only to matters well ascertained before any of them were written :—but as each professes to contain something of original discovery, or of

correction of received views, it does surprise even my partiality, that they should have the degree of consistency and apparent general accuracy which they seem to me to present.

I have made some alterations in the text, but they have been altogether of a typographical or grammatical character; and even where greatest, have been intended to explain the sense, not to alter it. I have often added Notes at the bottom of the page, as to paragraphs 59, 360, 439, 521, 552, 555, 598, 657, 883, for the correction of errors, and also the purpose of illustration: but these are all distinguished from the Original Notes of the Researhes by the date of *Dec.* 1838.

The date of a scientific paper containing any pretensions to discovery is frequently a matter of serious importance, and it is a great misfortune that there are many most valuable communications, essential to the history and progress of science, with respect to which this point cannot now be ascertained. This arises from the circumstance of the papers having no dates attached to them individually, and of the journals in which they appear having such as are inaccurate, *i. e.* dates of a period earlier than that of publication. I may refer to the note at the end of the First Series, as an illustration of the kind of confusion thus produced. These circumstances have induced me to affix a date at the top of every other page, and I have thought myself justified in using that placed by the Secretary of the Royal Society on each paper as it was received. An author has no right, perhaps, to claim an earlier one, unless it has received confirmation by some public act or officer.

Before concluding these lines I would beg leave to make a reference or two ; first, to my own Papers on Electro-magnetic Rotations in the Quarterly Journal of Science, 1822., xii. 74. 186. 283. 416. and also to my Letter on Magneto-electric Induction in the Annales de Chimie, li. p. 404. These might, as to the matter, very properly have appeared in this volume, but they would have interfered with it as a simple reprint of the "Experimental Researches" of the Philosophical Transactions.

Then I wish to refer, in relation to the Fourth Series on a new law of Electric Conduction, to Franklin's experiments on the non-conduction of ice, which have been very properly separated and set forth by Professor Bache, (Journal of the Franklin Institute, 1836. xvii. 183). These, which I did not at all remember as to the extent of the effect, though they in no way anticipate the expression of the law I state as to the general effect of liquefaction on electrolytes, still should never be forgotten when speaking of that law as applicable to the case of water.

There are two papers which I am anxious to refer to, as corrections or criticisms of parts of the Experimental Researches. The first of these is one by Jacobi, (Philosophical Magazine, 1838, xiii. 401) relative to the possible production of a spark on completing the junction of the two metals of a single pair of plates (915.). It is an excellent paper, and though I have not repeated the experiments, the description of them convinces me that I must have been in error. The second is by that excellent philosopher, Marianini, (Memoria della Societa Italiana di Modena, xxi. 205), and is a critical and experimental examination of

Series viii, and of the question whether metallic contact is or is not *productive* of a part of the electricity of the voltaic pile. I see no reason as yet to alter the opinion I have given; but the paper is so very valuable, comes to the question so directly, and the point itself is of such great importance, that I intend at the first opportunity renewing the inquiry, and, if I can, rendering the proofs either on the one side or the other undeniable to all.

Other parts of these researches have received the honor of critical attention from various philosophers, to all of whom I am obliged, and some of whose corrections I have acknowledged in the foot notes. There are, no doubt, occasions on which I have not felt the force of the remarks, but time and the progress of science will best settle such cases; and, although I cannot honestly say that I *wish* to be found in error, yet I do fervently hope that the progress of science in the hands of its many zealous present cultivators will be such, as by giving us new and other developments, and laws more and more general in their applications, will even make me think that what is written and illustrated in these experimental researches, belongs to the by-gone parts of science.

MICHAEL FARADAY.

Royal Institution,
March, 1839.

CONTENTS.

		Par.
Series I.	§. 1. Induction of electric currents	6
	§. 2. Evolution of electricity from magnetism	27
	§. 3. New electrical state or condition of matter . .	60
	§. 4. Explication of Arago's magnetic phenomena .	81
Series II.	§. 5. Terrestrial magneto-electric induction	140
	§. 6. Force and direction of magneto-electric induction generally	193
Series III.	§. 7. Identity of electricities from different sources	265
	—— ————— i Voltaic electricity	268
	—— ————— ii Ordinary electricity	284
	—— ————— iii Magneto-electricity	343
	—— ————— iv Thermo-electricity	349
	—— ————— v Animal electricity	351
	§. 8. Relation by measure of common and voltaic electricity	361
	—— Note respecting Ampère's inductive results after	379
Series IV.	§. 9. New law of electric conduction	380
	§. 10. On conducting power generally	418
Series V.	§. 11. Electro-chemical decomposition	450
	—— ¶ 1. New conditions of electro-chemical decomposition	453
	—— ¶ 2. Influence of water in such decomposition	472
	—— ¶ 3. Theory of electro-chemical decomposition	477
Series VI.	§. 12. Power of platina &c. to induce combination .	564
Series VII.	§. 11.* Electro-chemical decomposition continued (nomenclature)	661
	—— ¶ 4. Some general conditions of electro-chemical decomposition	669
	—— ¶ 5. Volta-electrometer	704
	—— ¶ 6. Primary and secondary results	742
	—— ¶ 7. Definite nature and extent of electro-chemical forces	783
	—— Electro-chemical equivalents	822

	Par.
	§. 13. Absolute quantity of electricity in the molecules of matter 852
Series VIII.	§. 14. Electricity of the voltaic pile 875
	— ¶ 1. Simple voltaic circles 875
	— ¶ 2. Electrolytic intensity 966
	— ¶ 3. Associated voltaic circles ; or battery . . 989
	— ¶ 4. Resistance of an electrolyte to decomposition 1007
	— ¶ 5. General remarks on the active battery . . 1034
Series IX.	§. 15. Induction of a current on itself 1048
	— Inductive action of currents generally 1101
Series X.	§. 16. Improved voltaic battery 1119
	§. 17. Practical results with the voltaic battery . . 1136
Series XI.	§. 18. On static induction 1161
	— ¶ 1. Induction and action of contiguous particles 1161
	— ¶ 2. Absolute charge of matter 1169
	— ¶ 3. Electrometer and inductive apparatus . . 1179
	— ¶ 4. Induction in curved lines 1215
	— Conduction by glass, lac, sulphur, &c. . . . 1233
	— ¶ 5. Specific inductive capacity 1252
	— ¶ 6. General results as to the nature of induction 1295
	— Differential inductometer 1307
Series XII.	— ¶ 7. Conduction or conductive discharge 1320
	— ¶ 8. Electrolytic discharge 1343
	— ¶ 9. Disruptive discharge 1359
	— Insulation 1362
	— as spark 1406
	— as brush 1425
	— positivo and negative 1465
Series XIII.	— as glow 1526
	— dark 1544
	— ¶ 10. Convection ; or carrying discharge . . 1562
	— ¶ 11. Relation of a vacuum to electrical phenomena 1613
	§. 19. Nature of the electric current 1617
	— its transverse forces 1653
Series XIV.	§. 20. Nature of the electric force or forces 1667
	§. 21. Relation of the electric and magnetic forces . 1709
	§. 22. Note on electrical excitation 1737

EXPERIMENTAL RESEARCHES

IN

ELECTRICITY.

FIRST SERIES.

§ 1. *On the Induction of Electric Currents.* § 2. *On the Evolution of Electricity from Magnetism.* § 3. *On a new Electrical Condition of Matter.* § 4. *On Arago's Magnetic Phenomena.*

[Read November 24, 1831.]

1. THE power which electricity of tension possesses of causing an opposite electrical state in its vicinity has been expressed by the general term Induction; which, as it has been received into scientific language, may also, with propriety, be used in the same general sense to express the power which electrical currents may possess of inducing any particular state upon matter in their immediate neighbourhood, otherwise indifferent. It is with this meaning that I purpose using it in the present paper.

2. Certain effects of the induction of electrical currents have already been recognised and described: as those of magnetization; Ampère's experiments of bringing a copper disc near to a flat spiral; his repetition with electro-magnets of Arago's extraordinary experiments, and perhaps a few others. Still it appeared unlikely that these could be all the effects which induction by currents could produce; especially as, upon dispensing with iron, almost the whole of them disappear, whilst yet an infinity of bodies, exhibiting definite phenomena of in-

duction with electricity of tension, still remain to be acted upon by the induction of electricity in motion.

3. Further: Whether Ampère's beautiful theory were adopted, or any other, or whatever reservation were mentally made, still it appeared very extraordinary, that as every electric current was accompanied by a corresponding intensity of magnetic action at right angles to the current, good conductors of electricity, when placed within the sphere of this action, should not have any current induced through them, or some sensible effect produced equivalent in force to such a current.

4. These considerations, with their consequence, the hope of obtaining electricity from ordinary magnetism, have stimulated me at various times to investigate experimentally the inductive effect of electric currents. I lately arrived at positive results; and not only had my hopes fulfilled, but obtained a key which appeared to me to open out a full explanation of Arago's magnetic phenomena, and also to discover a new state, which may probably have great influence in some of the most important effects of electric currents.

5. These results I purpose describing, not as they were obtained, but in such a manner as to give the most concise view of the whole.

§ 1. *Induction of Electric Currents.*

6. About twenty-six feet of copper wire one twentieth of an inch in diameter were wound round a cylinder of wood as a helix, the different spires of which were prevented from touching by a thin interposed twine. This helix was covered with calico, and then a second wire applied in the same manner. In this way twelve helices were superposed, each containing an average length of wire of twenty-seven feet, and all in the same direction. The first, third, fifth, seventh, ninth, and eleventh of these helices were connected at their extremities end to end, so as to form one helix; the others were connected in a similar manner; and thus two principal helices were produced, closely interposed, having the same direction, not touching anywhere, and each containing one hundred and fifty-five feet in length of wire.

7. One of these helices was connected with a galvanometer, the other with a voltaic battery of ten pairs of plates four inches

square, with double coppers and well charged; yet not the slightest sensible deflection of the galvanometer needle could be observed.

8. A similar compound helix, consisting of six lengths of copper and six of soft iron wire, was constructed. The resulting iron helix contained two hundred and fourteen feet of wire, the resulting copper helix two hundred and eight feet; but whether the current from the trough was passed through the copper or the iron helix, no effect upon the other could be perceived at the galvanometer.

9. In these and many similar experiments no difference in action of any kind appeared between iron and other metals.

10. Two hundred and three feet of copper wire in one length were coiled round a large block of wood; other two hundred and three feet of similar wire were interposed as a spiral between the turns of the first coil, and metallic contact everywhere prevented by twine. One of these helices was connected with a galvanometer, and the other with a battery of one hundred pairs of plates four inches square, with double coppers, and well charged. When the contact was made, there was a sudden and very slight effect at the galvanometer, and there was also a similar slight effect when the contact with the battery was broken. But whilst the voltaic current was continuing to pass through the one helix, no galvanometrical appearances nor any effect like induction upon the other helix could be perceived, although the active power of the battery was proved to be great, by its heating the whole of its own helix, and by the brilliancy of the discharge when made through charcoal.

11. Repetition of the experiments with a battery of one hundred and twenty pairs of plates produced no other effects; but it was ascertained, both at this and the former time, that the slight deflection of the needle occurring at the moment of completing the connexion, was always in one direction, and that the equally slight deflection produced when the contact was broken, was in the other direction; and also, that these effects occurred when the first helices were used (6. 8.).

12. The results which I had by this time obtained with magnets led me to believe that the battery current through one wire, did, in reality, induce a similar current through the other

wire, but that it continued for an instant only, and partook more of the nature of the electrical wave passed through from the shock of a common Leyden jar than of the current from a voltaic battery, and therefore might magnetise a steel needle, although it scarcely affected the galvanometer.

13. This expectation was confirmed; for on substituting a small hollow helix, formed round a glass tube, for the galvanometer, introducing a steel needle, making contact as before between the battery and the inducing wire (7. 10.), and then removing the needle before the battery contact was broken, it was found magnetised.

14. When the battery contact was first made, then an unmagnetised needle introduced into the small indicating helix (13.), and lastly the battery contact broken, the needle was found magnetised to an equal degree apparently as before; but the poles were of the contrary kind.

15. The same effects took place on using the large compound helices first described (6. 8.).

16. When the unmagnetised needle was put into the indicating helix, before contact of the inducing wire with the battery, and remained there until the contact was broken, it exhibited little or no magnetism; the first effect having been nearly neutralised by the second (13. 14.). The force of the induced current upon making contact was found always to exceed that of the induced current at breaking of contact; and if therefore the contact was made and broken many times in succession, whilst the needle remained in the indicating helix, it at last came out not unmagnetised, but a needle magnetised as if the induced current upon making contact had acted alone on it. This effect may be due to the accumulation (as it is called) at the poles of the unconnected pile, rendering the current upon first making contact more powerful than what it is afterwards, at the moment of breaking contact.

17. If the circuit between the helix or wire under induction and the galvanometer or indicating spiral was not rendered complete *before* the connexion between the battery and the inducing wire was completed or broken, then no effects were perceived at the galvanometer. Thus, if the battery communications were first made, and then the wire under induction connected with the indicating helix, no magnetising power was

there exhibited. But still retaining the latter communications, when those with the battery were broken, a magnet was formed in the helix, but of the second kind (14.), *i. e.* with poles indicating a current in the same direction to that belonging to the battery current, or to that always induced by that current at its cessation.

18. In the preceding experiments the wires were placed near to each other, and the contact of the inducing one with the battery made when the inductive effect was required; but as the particular action might be supposed to be exerted only at the moments of making and breaking contact, the induction was produced in another way. Several feet of copper wire were stretched in wide zigzag forms, representing the letter W, on one surface of a broad board; a second wire was stretched in precisely similar forms on a second board, so that when brought near the first, the wires should everywhere touch, except that a sheet of thick paper was interposed. One of these wires was connected with the galvanometer, and the other with a voltaic battery. The first wire was then moved towards the second, and as it approached, the needle was deflected. Being then removed, the needle was deflected in the opposite direction. By first making the wires approach and then recede, simultaneously with the vibrations of the needle, the latter soon became very extensive; but when the wires ceased to move from or towards each other, the galvanometer-needle soon came to its usual position.

19. As the wires approximated, the induced current was in the *contrary* direction to the inducing current. As the wires receded, the induced current was in the *same* direction as the inducing current. When the wires remained stationary, there was no induced current (54.).

20. When a small voltaic arrangement was introduced into the circuit between the galvanometer (10.) and its helix or wire, so as to cause a permanent deflection of 30° or 40° , and then the battery of one hundred pairs of plates connected with the inducing wire, there was an instantaneous action as before (11.); but the galvanometer-needle immediately resumed and retained its place unaltered, notwithstanding the continued contact of the inducing wire with the trough: such was the case in whichever way the contacts were made (33.).

21. Hence it would appear that collateral currents, either in the same or in opposite directions, exert no permanent inducing power on each other, affecting their quantity or tension.

22. I could obtain no evidence by the tongue, by spark, or by heating fine wire or charcoal, of the electricity passing through the wire under induction; neither could I obtain any chemical effects, though the contacts with metallic and other solutions were made and broken alternately with those of the battery, so that the second effect of induction should not oppose or neutralize the first (13. 16.).

23. This deficiency of effect is not because the induced current of electricity cannot pass fluids, but probably because of its brief duration and feeble intensity; for on introducing two large copper plates into the circuit on the induced side (20.), the plates being immersed in brine, but prevented from touching each other by an interposed cloth, the effect at the indicating galvanometer or helix occurred as before. The induced electricity could also pass through a voltaic trough (20.). When, however, the quantity of interposed fluid was reduced to a drop, the galvanometer gave no indication.

24. Attempts to obtain similar effects by the use of wires conveying ordinary electricity were doubtful in the results. A compound helix similar to that already described, containing eight elementary helices (6.), was used. Four of the helices had their similar ends bound together by wire, and the two general terminations thus produced connected with the small magnetising helix containing an unmagnetised needle (13.). The other four helices were similarly arranged, but their ends connected with a Leyden jar. On passing the discharge, the needle was found to be a magnet; but it appeared probable that a part of the electricity of the jar had passed off to the small helix, and so magnetised the needle. There was indeed no reason to expect that the electricity of a jar possessing as it does great tension, would not diffuse itself through all the metallic matter interposed between the coatings.

25. Still it does not follow that the discharge of ordinary electricity through a wire does not produce analagous phenomena to those arising from voltaic electricity; but as it appears impossible to separate the effects produced at the moment when the discharge begins to pass, from the equal and contrary effects

produced when it ceases to pass (16.), inasmuch as with ordinary electricity these periods are simultaneous, so there can be scarcely any hope that in this form of the experiment they can be perceived.

26. Hence it is evident that currents of voltaic electricity present phenomena of induction somewhat analogous to those produced by electricity of tension, although, as will be seen hereafter, many differences exist between them. The result is the production of other currents, (but which are only momentary,) parallel, or tending to parallelism, with the inducing current. By reference to the poles of the needle formed in the inducing helix (13. 14.) and to the deflections of the galvanometer-needle (11.), it was found in all cases that the induced current, produced by the first action of the inducing current, was in the contrary direction to the latter, but that the current produced by the cessation of the inducing current was in the same direction (19.). For the purpose of avoiding periphrasis, I propose to call this action of the current from the voltaic battery *volta-electric induction*. The properties of the second wire, after induction has developed the first current, and whilst the electricity from the battery continues to flow through its inducing neighbour (10. 18.), constitute a peculiar electric condition, the consideration of which will be resumed hereafter (60.). All these results have been obtained with a voltaic apparatus consisting of a single pair of plates.

§ 2. *Evolution of Electricity from Magnetism.*

27. A welded ring was made of soft round bar-iron, the metal being seven eighths of an inch in thickness, and the ring six inches in external diameter. Three helices were put round one part of this ring, each containing about twenty-four feet of copper wire one twentieth of an inch thick; they were insulated from the iron and each other, and superposed in the manner before described (6.), occupying about nine inches in length upon the ring. They could be used separately or conjointly; the group may be distinguished by the letter A (Pl. I. fig. 1.). On the other part of the ring about sixty feet of similar copper wire in two pieces were applied in the same manner, forming a helix B, which had the same common direction with the helices

of A, but being separated from it at each extremity by about half an inch of the uncovered iron.

28. The helix B was connected by copper wires with a galvanometer three feet from the ring. The helices of A were connected end to end so as to form one common helix, the extremities of which were connected with a battery of ten pairs of plates four inches square. The galvanometer was immediately affected, and to a degree far beyond what has been described when with a battery of tenfold power helices *without iron* were used (10.); but though the contact was continued, the effect was not permanent, for the needle soon came to rest in its natural position, as if quite indifferent to the attached electro-magnetic arrangement. Upon breaking the contact with the battery, the needle was again powerfully deflected, but in the contrary direction to that induced in the first instance.

29. Upon arranging the apparatus so that B should be out of use, the galvanometer be connected with one of the three wires of A (27.), and the other two made into a helix through which the current from the trough (28.) was passed, similar but rather more powerful effects were produced.

30. When the battery contact was made in one direction, the galvanometer-needle was deflected on the one side; if made in the other direction, the deflection was on the other side. The deflection on breaking the battery contact was always the reverse of that produced by completing it. The deflection on making a battery contact always indicated an induced current in the opposite direction to that from the battery; but on breaking the contact the deflection indicated an induced current in the same direction as that of the battery. No making or breaking of the contact at B side, or in any part of the galvanometer circuit, produced any effect at the galvanometer. No continuance of the battery current caused any deflection of the galvanometer-needle. As the above results are common to all these experiments, and to similar ones with ordinary magnets to be hereafter detailed, they need not be again particularly described.

31. Upon using the power of one hundred pairs of plates (10.) with this ring, the impulse at the galvanometer, when

contact was completed or broken, was so great as to make the needle spin round rapidly four or five times, before the air and terrestrial magnetism could reduce its motion to mere oscillation.

32. By using charcoal at the ends of the B helix, a minute *spark* could be perceived when the contact of the battery with A was completed. This spark could not be due to any diversion of a part of the current of the battery through the iron to the helix B; for when the battery contact was continued, the galvanometer still resumed its perfectly indifferent state (28.). The spark was rarely seen on breaking contact. A small platinum wire could not be ignited by this induced current; but there seems every reason to believe that the effect would be obtained by using a stronger original current or a more powerful arrangement of helices.

33. A feeble voltaic current was sent through the helix B and the galvanometer, so as to deflect the needle of the latter 30° or 40° , and then the battery of one hundred pairs of plates connected with A; but after the first effect was over, the galvanometer-needle resumed exactly the position due to the feeble current transmitted by its own wire. This took place in whichever way the battery contacts were made, and shows that here again (20.) no permanent influence of the currents upon each other, as to their quantity and tension, exists.

34. Another arrangement was then employed connecting the former experiments on volta-electric induction (6—26.) with the present. A combination of helices like that already described (6.) was constructed upon a hollow cylinder of pasteboard: there were eight lengths of copper wire, containing altogether 220 feet; four of these helices were connected end to end, and then with the galvanometer (7.); the other intervening four were also connected end to end, and the battery of one hundred pairs discharged through them. In this form the effect on the galvanometer was hardly sensible (11.), though magnets could be made by the induced current (13.). But when a soft iron cylinder seven eighths of an inch thick, and twelve inches long, was introduced into the pasteboard tube, surrounded by the helices, then the induced current affected the galvanometer powerfully, and with all the phenomena just described (30.). It possessed also the power of making mag-

nets with more energy, apparently, than when no iron cylinder was present.

35. When the iron cylinder was replaced by an equal cylinder of copper, no effect beyond that of the helices alone was produced. The iron cylinder arrangement was not so powerful as the ring arrangement already described (27.).

36. Similar effects were then produced by *ordinary magnets*: thus the hollow helix just described (34.) had all its elementary helices connected with the galvanometer by two copper wires, each five feet in length; the soft iron cylinder was introduced into its axis; a couple of bar magnets, each twenty-four inches long, were arranged with their opposite poles at one end in contact, so as to resemble a horse-shoe magnet, and then contact made between the other poles and the ends of the iron cylinder, so as to convert it for the time into a magnet (fig. 2.): by breaking the magnetic contacts, or reversing them, the magnetism of the iron cylinder could be destroyed or reversed at pleasure.

37. Upon making magnetic contact, the needle was deflected; continuing the contact, the needle became indifferent, and resumed its first position; on breaking the contact, it was again deflected, but in the opposite direction to the first effect, and then it again became indifferent. When the magnetic contacts were reversed the deflections were reversed.

38. When the magnetic contact was made, the deflection was such as to indicate an induced current of electricity in the opposite direction to that fitted to form a magnet, having the same polarity as that really produced by contact with the bar magnets. Thus when the marked and unmarked poles were placed as in fig. 3, the current in the helix was in the direction represented, P being supposed to be the end of the wire going to the positive pole of the battery, or that end towards which the zinc plates face, and N the negative wire. Such a current would have converted the cylinder into a magnet of the opposite kind to that formed by contact with the poles A and B; and such a current moves in the opposite direction to the currents which in M. Ampère's beautiful theory are considered as constituting a magnet in the position figured*.

* The relative position of an electric current and a magnet is by most persons found very difficult to remember, and three or four helps to the memory

39. But as it might be supposed that in all the preceding experiments of this section, it was by some peculiar effect taking place during the formation of the magnet, and not by its mere virtual approximation, that the momentary induced current was excited, the following experiment was made. All the similar ends of the compound hollow helix (34.) were bound together by copper wire, forming two general terminations, and these were connected with the galvanometer. The soft iron cylinder (34.) was removed, and a cylindrical magnet, three quarters of an inch in diameter and eight inches and a half in length, used instead. One end of this magnet was introduced into the axis of the helix (fig. 4.), and then, the galvanometer-needle being stationary, the magnet was suddenly thrust in; immediately the needle was deflected in the same direction as if the magnet had been formed by either of the two preceding processes (34. 36.). Being left in, the needle resumed its first position, and then the magnet being withdrawn the needle was deflected in the opposite direction. These effects were not great; but by introducing and withdrawing the magnet, so that the impulse each time should be added to those previously communicated to the needle, the latter could be made to vibrate through an arc of 180° or more.

40. In this experiment the magnet must not be passed entirely through the helix, for then a second action occurs. When the magnet is introduced, the needle at the galvanometer is deflected in a certain direction; but being in, whether it be pushed quite through or withdrawn, the needle is deflected in a direction the reverse of that previously produced. When the magnet is passed in and through at one continuous motion, have been devised by M. Ampère and others. I venture to suggest the following as a very simple and effectual assistance in these and similar latitudes. Let the experimenter think he is looking down upon a dipping needle, or upon the pole of the earth, and then let him think upon the direction of the motion of the hands of a watch, or of a screw moving direct; currents in that direction round a needle would make it into such a magnet as the dipping needle, or would themselves constitute an electro-magnet of similar qualities; or if brought near a magnet would tend to make it take that direction; or would themselves be moved into that position by a magnet so placed; or in M. Ampère's theory are considered as moving in that direction in the magnet. These two points of the position of the dipping-needle and the motion of the watch hands being remembered, any other relation of the current and the magnet can be at once deduced from it.

the needle moves one way, is then suddenly stopped, and finally moves the other way.

41. If such a hollow helix as that described (34.) be laid east and west (or in any other constant position), and a magnet be retained east and west, its marked pole always being one way; then whichever end of the helix the magnet goes in at, and consequently whichever pole of the magnet enters first, still the needle is deflected the same way: on the other hand, whichever direction is followed in withdrawing the magnet, the deflection is constant, but contrary to that due to its entrance.

42. These effects are simple consequences of the *law* hereafter to be described (114.).

43. When the eight elementary helices were made one long helix, the effect was not so great as in the arrangement described. When only one of the eight helices was used, the effect was also much diminished. All care was taken to guard against any direct action of the inducing magnet upon the galvanometer, and it was found that by moving the magnet in the same direction, and to the same degree on the outside of the helix no effect on the needle was produced.

44. The Royal Society are in possession of a large compound magnet formerly belonging to Dr. Gowin Knight, which, by permission of the President and Council, I was allowed to use in the prosecution of these experiments: it is at present in the charge of Mr. Christie, at his house at Woolwich, where, by Mr. Christie's kindness, I was at liberty to work; and I have to acknowledge my obligations to him for his assistance in all the experiments and observations made with it. This magnet is composed of about 450 bar magnets, each fifteen inches long, one inch wide, and half an inch thick, arranged in a box so as to present at one of its extremities two external poles (fig. 5.). These poles projected horizontally six inches from the box, were each twelve inches high and three inches wide. They were nine inches apart; and when a soft iron cylinder, three quarters of an inch in diameter and twelve inches long, was put across from one to the other, it required a force of nearly one hundred pounds to break the contact. The pole to the left in the figure is the marked pole*.

* To avoid any confusion as to the poles of the magnet, I shall designate the

45. The indicating galvanometer, in all experiments made with this magnet, was about eight feet from it, not directly in front of the poles, but about 16° or 17° on one side. It was found that on making or breaking the connexion of the poles by soft iron, the instrument was slightly affected; but all error of observation arising from this cause was easily and carefully avoided.

46. The electrical effects exhibited by this magnet were very striking. When a soft iron cylinder thirteen inches long was put through the compound hollow helix, with its ends arranged as two general terminations (39.), these connected with the galvanometer, and the iron cylinder brought in contact with the two poles of the magnet (fig. 5.), so powerful a rush of electricity took place that the needle whirled round many times in succession*.

47. Notwithstanding this great power, if the contact was continued, the needle resumed its natural position, being entirely uninfluenced by the position of the helix (30.). But on breaking the magnetic contact, the needle was whirled round in the opposite direction with a force equal to the former.

48. A piece of copper plate wrapped *once* round the iron cylinder like a socket, but with interposed paper to prevent contact, had its edges connected with the wires of the galvanometer. When the iron was brought in contact with the poles the galvanometer was strongly affected.

49. Dismissing the helices and sockets, the galvanometer wire was passed over, and consequently only half round the iron cylinder (fig. 6.); but even then a strong effect upon the needle was exhibited, when the magnetic contact was made or broken.

50. As the helix with its iron cylinder was brought towards the magnetic poles, but *without making contact*, still powerful effects were produced. When the helix, without the iron cylinder, and consequently containing no metal but copper, was approached to, or placed between the poles (44.), the needle pole pointing to the north as the marked pole; I may occasionally speak of the north and south ends of the needle, but do not mean thereby north and south poles. That is by many considered the true north pole of a needle which points to the south; but in this country it is often called the south pole.

* A soft iron bar in the form of a lifter to a horse-shoe magnet, when supplied with a coil of this kind round the middle of it, becomes, by juxtaposition with a magnet, a ready source of a brief but determinate current of electricity.

was thrown 80° , 90° , or more, from its natural position. The inductive force was of course greater, the nearer the helix, either with or without its iron cylinder, was brought to the poles; but otherwise the same effects were produced, whether the helix, &c. was or was not brought into contact with the magnet; *i. e.* no permanent effect on the galvanometer was produced; and the effects of approximation and removal were the reverse of each other (30.).

51. When a bolt of copper corresponding to the iron cylinder was introduced, no greater effect was produced by the helix than without it. But when a thick iron wire was substituted, the magneto-electric induction was rendered sensibly greater.

52. The direction of the electric current produced in all these experiments with the helix, was the same as that already described (38.) as obtained with the weaker bar magnets.

53. A spiral containing fourteen feet of copper wire, being connected with the galvanometer, and approximated directly towards the marked pole in the line of its axis, affected the instrument strongly; the current induced in it was in the reverse direction to the current theoretically considered by M. Ampère as existing in the magnet (38.), or as the current in an electro-magnet of similar polarity. As the spiral was withdrawn, the induced current was reversed.

54. A similar spiral had the current of eighty pairs of 4-inch plates sent through it so as to form an electro-magnet, and then the other spiral connected with the galvanometer (53.) approximated to it; the needle vibrated, indicating a current in the galvanometer spiral the reverse of that in the battery spiral (18. 26.). On withdrawing the latter spiral, the needle passed in the opposite direction.

55. Single wires, approximated in certain directions towards the magnetic pole, had currents induced in them. On their removal, the currents were inverted. In such experiments the wires should not be removed in directions different to those in which they were approximated; for then occasionally complicated and irregular effects are produced, the causes of which will be very evident in the fourth part of this paper.

56. All attempts to obtain chemical effects by the induced current of electricity failed, though the precautions before described (22.), and all others that could be thought of, were em-

ployed. Neither was any sensation on the tongue, or any convulsive effect upon the limbs of a frog, produced. Nor could charcoal or fine wire be ignited (133.). But upon repeating the experiments more at leisure at the Royal Institution, with an armed loadstone belonging to Professor Daniell and capable of lifting about thirty pounds, a frog was very *powerfully convulsed* each time magnetic contact was made. At first the convulsions could not be obtained on breaking magnetic contact; but conceiving the deficiency of effect was because of the comparative slowness of separation, the latter act was effected by a blow, and then the frog was convulsed strongly. The more instantaneous the union or disunion is effected, the more powerful the convulsion. I thought also I could perceive the *sensation* upon the tongue and the *flash* before the eyes; but I could obtain no evidence of chemical decomposition.

57. The various experiments of this section prove, I think, most completely the production of electricity from ordinary magnetism. That its intensity should be very feeble and quantity small, cannot be considered wonderful, when it is remembered that like thermo-electricity it is evolved entirely within the substance of metals retaining all their conducting power. But an agent which is conducted along metallic wires in the manner described; which, whilst so passing possesses the peculiar magnetic actions and force of a current of electricity; which can agitate and convulse the limbs of a frog; and which, finally, can produce a spark* by its discharge through charcoal (32.), can only be electricity. As all the effects can be produced by ferruginous electro-magnets (34.), there is no doubt that arrangements like the magnets of Professors Moll, Henry, Ten Eyke, and others, in which as many as two thousand pounds have been lifted, may be used for these experiments; in which case not only a brighter spark may be obtained, but wires also ignited, and, as the current can pass liquids (23.), chemical action be produced. These effects are still more likely to be obtained when the magneto-electric arrangements to be explained in the fourth section are excited by the powers of such apparatus.

* For a mode of obtaining the spark from the common magnet which I have found effectual, see the Philosophical Magazine for June 1832, p. 5. In the same Journal for November 1834, vol. v. p. 349, will be found a method of obtaining the magneto-electric spark, still simpler in its principle, the use of soft iron being dispensed with altogether.—*Dec.* 1838.

58. The similarity of action, almost amounting to identity, between common magnets and either electro-magnets or volta-electric currents, is strikingly in accordance with and confirmatory of M. Ampère's theory, and furnishes powerful reasons for believing that the action is the same in both cases; but, as a distinction in language is still necessary, I propose to call the agency thus exerted by ordinary magnets, *magneto-electric* or *magnelectric* induction (26.).

59. The only difference which powerfully strikes the attention as existing between volta-electric and magneto-electric induction, is the suddenness of the former, and the sensible time required by the latter: but even in this early state of investigation there are circumstances which seem to indicate, that upon further inquiry this difference will, as a philosophical distinction, disappear (68.)*.

§ 3. *New Electrical State or Condition of Matter* †.

60. Whilst the wire is subject to either volta-electric or magneto-electric induction, it appears to be in a peculiar state; for it resists the formation of an electrical current in it, whereas, if in its common condition, such a current would be produced; and when left uninfluenced it has the power of originating a current, a power which the wire does not possess under common circumstances. This electrical condition of matter has not hitherto been recognised, but it probably exerts a very important influence in many if not most of the phenomena produced by currents of electricity. For reasons which will immediately appear (71.), I have, after advising with several learned friends, ventured to designate it as the *electro-tonic* state.

61. This peculiar condition shows no known electrical effects whilst it continues; nor have I yet been able to discover any

* For important additional phenomena and developments of the induction of electrical currents, see now the ninth series, 1048-1118.—*Dec.* 1838.

† This section having been read at the Royal Society and reported upon, and having also, in consequence of a letter from myself to M. Hachette, been noticed at the French Institute, I feel bound to let it stand as part of the paper; but later investigations (intimated 73. 76. 77.) of the laws governing these phenomena, induce me to think that the latter can be fully explained without admitting the electro-tonic state. My views on this point will appear in the second series of these researches.—M. F.

peculiar powers exerted, or properties possessed, by matter whilst retained in this state.

62. It shows no reaction by attractive or repulsive powers. The various experiments which have been made with powerful magnets upon such metals as copper, silver, and generally those substances not magnetic, prove this point; for the substances experimented upon, if electrical conductors, must have acquired this state; and yet no evidence of attractive or repulsive powers has been observed. I have placed copper and silver discs, very delicately suspended on torsion balances in vacuo near to the poles of very powerful magnets, yet have not been able to observe the least attractive or repulsive force.

63. I have also arranged a fine slip of gold-leaf very near to a bar of copper, the two being in metallic contact by mercury at their extremities. These have been placed in vacuo, so that metal rods connected with the extremities of the arrangement should pass through the sides of the vessel into the air. I have then moved powerful magnetic poles, about this arrangement, in various directions, the metallic circuit on the outside being sometimes completed by wires, and sometimes broken. But I never could obtain any sensible motion of the gold-leaf, either directed to the magnet or towards the collateral bar of copper, which must have been, as far as induction was concerned, in a similar state to itself.

64. In some cases it has been supposed that, under such circumstances, attractive and repulsive forces have been exhibited, *i. e.* that such bodies have become slightly magnetic. But the phenomena now described, in conjunction with the confidence we may reasonably repose in M. Ampère's theory of magnetism, tend to throw doubt on such cases; for if magnetism depend upon the attraction of electrical currents, and if the powerful currents at first excited, both by volta-electric and magneto-electric induction, instantly and naturally cease (12. 28. 47.), causing at the same time an entire cessation of magnetic effects at the galvanometer needle, then there can be little or no expectation that any substances not partaking of the peculiar relation in which iron, nickel, and one or two other bodies, stand, should exhibit magneto-attractive powers. It seems far more probable, that the extremely feeble permanent effects ob-

served have been due to traces of iron, or perhaps some other unrecognized cause not magnetic.

65. This peculiar condition exerts no retarding or accelerating power upon electrical currents passing through metal thus circumstanced (20. 33.). Neither could any such power upon the inducing current itself be detected; for when masses of metal, wires, helices, &c. were arranged in all possible ways by the side of a wire or helix, carrying a current measured by the galvanometer (20.), not the slightest permanent change in the indication of the instrument could be perceived. Metal in the supposed peculiar state, therefore, conducts electricity in all directions with its ordinary facility, or, in other words, its conducting power is not sensibly altered by it.

66. All metals take on the peculiar state. This is proved in the preceding experiments with copper and iron (9.), and with gold, silver, tin, lead, zinc, antimony, bismuth, mercury, &c. by experiments to be described in the fourth part (132.), admitting of easy application. With regard to iron, the experiments prove the thorough and remarkable independence of these phenomena of induction, and the ordinary magnetical appearances of that metal.

67. This state is altogether the effect of the induction exerted, and ceases as soon as the inductive force is removed. It is the same state, whether produced by the collateral passage of voltaic currents (26.), or the formation of a magnet (34. 36.), or the mere approximation of a magnet (39. 50.); and is a strong proof in addition to those advanced by M. Ampère, of the identity of the agents concerned in these several operations. It probably occurs, momentarily, during the passage of the common electric spark (24.), and may perhaps be obtained hereafter in bad conductors by weak electrical currents or other means (74. 76.).

68. The state appears to be instantly assumed (12.), requiring hardly a sensible portion of time for that purpose. The *difference* of time between volta-electric and magneto-electric induction, rendered evident by the galvanometer (59.), may probably be thus explained. When a voltaic current is sent through one of two parallel wires, as those of the hollow helix (34.), a current is produced in the other wire, as brief in its

continuance as the time required for a single action of this kind, and which, by experiment, is found to be inappreciably small. The action will seem still more instantaneous, because, as there is an accumulation of power in the poles of the battery before contact, the first rush of electricity in the wire of communication is greater than that sustained after the contact is completed; the wire of induction becomes at the moment electrotonic to an equivalent degree, which the moment after sinks to the state in which the continuous current can sustain it, but in sinking, causes an opposite induced current to that at first produced. The consequence is, that the first induced wave of electricity more resembles that from the discharge of an electric jar, than it otherwise would do.

69. But when the iron cylinder is put into the same helix (34.), previous to the connexion being made with the battery, then the current from the latter may be considered as active in inducing innumerable currents of a similar kind to itself in the iron, rendering it a magnet. This is known by experiment to occupy time; for a magnet so formed, even of soft iron, does not rise to its fullest intensity in an instant, and it may be because the currents within the iron are successive in their formation or arrangement. But as the magnet can induce, as well as the battery current, the combined action of the two continues to evolve induced electricity, until their joint effect is at a maximum, and thus the existence of the deflecting force is prolonged sufficiently to overcome the inertia of the galvanometer needle.

70. In all those cases where the helices or wires are advanced towards or taken from the magnet (50. 55.), the direct or inverted current of induced electricity continues for the time occupied in the advance or recession; for the electrotonic state is rising to a higher or falling to a lower degree during that time, and the change is accompanied by its corresponding evolution of electricity; but these form no objections to the opinion that the electrotonic state is instantly assumed.

71. This peculiar state appears to be a state of tension, and may be considered as *equivalent* to a current of electricity, at least equal to that produced either when the condition is induced or destroyed. The current evolved, however, first or last, is not to be considered a measure of the degree of tension

to which the electro-tonic state has risen ; for as the metal retains its conducting powers unimpaired (65.), and as the electricity evolved is but for a moment, (the peculiar state being instantly assumed and lost (68.)) the electricity which may be led away by long wire conductors, offering obstruction in their substance proportionate to their small lateral and extensive linear dimensions, can be but a very small portion of that really evolved within the mass at the moment it assumes this condition. Insulated helices and portions of metal instantly assumed the state ; and no traces of electricity could be discovered in them, however quickly the contact with the electrometer was made, after they were put under induction, either by the current from the battery or the magnet. A single drop of water or a small piece of moistened paper (23. 56.) was obstacle sufficient to stop the current through the conductors, the electricity evolved returning to a state of equilibrium through the metal itself, and consequently in an unobserved manner.

72. The tension of this state may therefore be comparatively very great. But whether great or small, it is hardly conceivable that it should exist without exerting a reaction upon the original inducing current, and producing equilibrium of some kind. It might be anticipated that this would give rise to a retardation of the original current ; but I have not been able to ascertain that this is the case. Neither have I in any other way as yet been able to distinguish effects attributable to such a reaction.

73. All the results favour the notion that the electro-tonic state relates to the particles, and not to the mass, of the wire or substance under induction, being in that respect different to the induction exerted by electricity of tension. If so, the state may be assumed in liquids when no electrical current is sensible, and even in non-conductors ; the current itself, when it occurs, being as it were a contingency due to the existence of conducting power, and the momentary propulsive force exerted by the particles during their arrangement. Even when conducting power is equal, the currents of electricity, which as yet are the only indicators of this state, may be unequal, because of differences as to number, size, electrical condition, &c. &c. in the particles themselves. It will only be after the laws

which govern this new state are ascertained, that we shall be able to predict what is the true condition of, and what are the electrical results obtainable from, any particular substance.

74. The current of electricity which induces the electrotonic state in a neighbouring wire, probably induces that state also in its own wire; for when by a current in one wire a collateral wire is made electro-tonic, the latter state is not rendered any way incompatible or interfering with a current of electricity passing through it (62.). If, therefore, the current were sent through the second wire instead of the first, it does not seem probable that its inducing action upon the second would be less, but on the contrary more, because the distance between the agent and the matter acted upon would be very greatly diminished. A copper bolt had its extremities connected with a galvanometer, and then the poles of a battery of one hundred pairs of plates connected with the bolt, so as to send the current through it; the voltaic circuit was then suddenly broken, and the galvanometer observed for any indications of a return current through the copper bolt due to the discharge of its supposed electro-tonic state. No effect of the kind was obtained, nor indeed, for two reasons, ought it to be expected; for first, as the cessation of induction and the discharge of the electro-tonic condition are simultaneous, and not successive, the return current would only be equivalent to the neutralization of the last portion of the inducing current, and would not therefore show any alteration of direction; or assuming that time did intervene, and that the latter current was really distinct from the former, its short, sudden character (12. 26.) would prevent it from being thus recognized.

75. No difficulty arises, I think, in considering the wire thus rendered electro-tonic by its own current more than by any external current, especially when the apparent non-interference of that state with currents is considered (62. 71.). The simultaneous existence of the conducting and electro-tonic states finds an analogy in the manner in which electrical currents can be passed through magnets, where it is found that both the currents passed, and those of the magnets, preserve all their properties distinct from each other, and exert their mutual actions.

76. The reason given with regard to metals extends also to fluids and all other conductors, and leads to the conclusion that when electric currents are passed through them they also

assume the electro-tonic state. Should that prove to be the case, its influence in voltaic decomposition, and the transference of the elements to the poles, can hardly be doubted. In the electro-tonic state the homogeneous particles of matter appear to have assumed a regular but forced electrical arrangement in the direction of the current, which if the matter be undecomposable, produces, when relieved, a return current; but in decomposable matter this forced state may be sufficient to make an elementary particle leave its companion, with which it is in a constrained condition, and associate with the neighbouring similar particle, in relation to which it is in a more natural condition, the forced electrical arrangement being itself discharged or relieved, at the same time, as effectually as if it had been freed from induction. But as the original voltaic current is continued, the electro-tonic state may be instantly renewed, producing the forced arrangement of the compound particles, to be as instantly discharged by a transference of the elementary particles of the opposite kind in opposite directions, but parallel to the current. Even the differences between common and voltaic electricity, when applied to effect chemical decomposition, which Dr. Wollaston has pointed out*, seem explicable by the circumstances connected with the induction of electricity from these two sources (25.). But as I have reserved this branch of the inquiry, that I might follow out the investigations contained in the present paper, I refrain (though much tempted) from offering further speculations.

77. Marianini has discovered and described a peculiar affection of the surfaces of metallic discs, when, being in contact with humid conductors, a current of electricity is passed through them; they are then capable of producing a reverse current of electricity, and Marianini has well applied the effect in explanation of the phenomena of Ritter's piles †. M. A. de la Rive has described a peculiar property acquired by metallic conductors, when being immersed in a liquid as poles, they have completed, for some time, the voltaic circuit, in consequence of which, when separated from the battery and plunged into the same fluid, they by themselves produce an electric current ‡. M. A. Van Beek has detailed cases in which the electrical relation of one metal in contact with another has been preserved

* Philosophical Transactions, 1801, p. 247.

† Annales de Chimie, XXXVIII. 5.

‡ Ibid. XXVIII. 190.

after separation, and accompanied by its corresponding chemical effects *. These states and results appear to differ from the electro-tonic state and its phenomena; but the true relation of the former to the latter can only be decided when our knowledge of all these phenomena has been enlarged.

78. I had occasion in the commencement of this paper (2.) to refer to an experiment by Ampère, as one of those dependent upon the electrical induction of currents made prior to the present investigation, and have arrived at conclusions which seem to imply doubts of the accuracy of the experiment (62. &c.): it is therefore due to M. Ampère that I should attend to it more distinctly. When a disc of copper (says M. Ampère) was suspended by a silk thread and surrounded by a helix or spiral, and when the charge of a powerful voltaic battery was sent through the spiral, a strong magnet at the same time being presented to the copper disc, the latter turned at the moment to take a position of equilibrium, exactly as the spiral itself would have turned had it been free to move. I have not been able to obtain this effect, nor indeed any motion; but the cause of my failure in the *latter* point may be due to the momentary existence of the current not allowing time for the inertia of the plate to be overcome (11. 12.). M. Ampère has perhaps succeeded in obtaining motion from the superior delicacy and power of his electro-magnetical apparatus, or he may have obtained only the motion due to cessation of action. But all my results tend to invert the sense of the proposition stated by M. Ampère, "that a current of electricity tends to put the electricity of conductors near which it passes in motion in the same direction," for they indicate an opposite direction for the produced current (26. 53.); and they show that the effect is momentary, and that it is also produced by magnetic induction, and that certain other extraordinary effects follow thereupon.

79. The momentary existence of the phenomena of induction now described is sufficient to furnish abundant reasons for the uncertainty or failure of the experiments, hitherto made to obtain electricity from magnets, or to effect chemical decomposition or arrangement by their means †.

* Annales de Chimie, XXXVIII. 49.

† The Lycée, No. 36, for January 1st, has a long and rather premature article, in which it endeavours to show anticipations by French philosophers of my researches. It however mistakes the erroneous results of MM. Fresnel and Ami-

80. It also appears capable of explaining fully the remarkable phenomena observed by M. Arago between metals and magnets when either are moving (120.), as well as most of the results obtained by Sir John Herschel, Messrs. Babbage, Harris, and others, in repeating his experiments; accounting at the same time perfectly for what at first appeared inexplicable; namely, the non-action of the same metals and magnets when at rest. These results, which also afford the readiest means of obtaining electricity from magnetism, I shall now proceed to describe.

§ 4. *Explication of Arago's Magnetic Phenomena.*

81. If a plate of copper be revolved close to a magnetic needle, or magnet, suspended in such a way that the latter may rotate in a plane parallel to that of the former, the magnet tends to follow the motion of the plate; or if the magnet be revolved, the plate tends to follow its motion; and the effect is so powerful, that magnets or plates of many pounds weight may be thus carried round. If the magnet and plate be at rest relative to each other, not the slightest effect, attractive or repulsive, or of any kind, can be observed between them (62.). This is the phenomenon discovered by M. Arago; and he states that the effect takes place not only with all metals, but with solids, liquids, and even gases, *i. e.* with all substances (130.).

82. Mr. Babbage and Sir John Herschel, on conjointly repeating the experiments in this country*, could obtain the effects only with the metals, and with carbon in a peculiar state (from gas retorts), *i. e.* only with excellent conductors of electricity. They refer the effect to magnetism induced in the plate by the magnet; the pole of the latter causing an opposite pole in the nearest part of the plate, and round this a more diffuse

père for true ones, and then imagines my true results are like those erroneous ones. I notice it here, however, for the purpose of doing honour to Fresnel in a much higher degree than would have been merited by a feeble anticipation of the present investigations. That great philosopher, at the same time with myself and fifty other persons, made experiments which the present paper proves could give no expected result. He was deceived for the moment, and published his imaginary success; but on more carefully repeating his trials, he could find no proof of their accuracy; and, in the high and pure philosophic desire to remove error as well as discover truth, he recanted his first statement. The example of Berzelius regarding the first Thorina is another instance of this fine feeling; and as occasions are not rare, it would be to the dignity of science if such examples were more frequently followed.—February 10th, 1832.

* Philosophical Transactions, 1825, p. 467.

polarity of its own kind (120.). The essential circumstance in producing the rotation of the suspended magnet is, that the substance revolving below it shall acquire and lose its magnetism in sensible time, and not instantly (124.). This theory refers the effect to an attractive force, and is not agreed to by the discoverer, M. Arago, nor by M. Ampère, who quote against it the absence of all attraction when the magnet and metal are at rest (62. 123.), although the induced magnetism should still remain; and who, from experiments made with a long dipping needle, conceive the action to be always repulsive (125.).

83. Upon obtaining electricity from magnets by the means already described (36. 46.), I hoped to make the experiment of M. Arago a new source of electricity; and did not despair, by reference to terrestrial magneto-electric induction, of being able to construct a new electrical machine. Thus stimulated, numerous experiments were made with the magnet of the Royal Society at Mr. Christie's house, in all of which I had the advantage of his assistance. As many of these were in the course of the investigation superseded by more perfect arrangements, I shall consider myself at liberty to rearrange them in a manner calculated to convey most readily what appears to me to be a correct view of the nature of the phenomena.

84. The magnet has been already described (44.). To concentrate the poles, and bring them nearer to each other, two iron or steel bars, each about six or seven inches long, one inch wide, and half an inch thick, were put across the poles as in fig. 7, and being supported by twine from slipping, could be placed as near to or far from each other as was required. Occasionally two bars of soft iron were employed, so bent that when applied, one to each pole, the two smaller resulting poles were vertically over each other, either being uppermost at pleasure.

85. A disc of copper, twelve inches in diameter, and about one fifth of an inch in thickness, fixed upon a brass axis, was mounted in frames so as to allow of revolution either vertically or horizontally, its edge being at the same time introduced more or less between the magnetic poles (fig. 7). The edge of the plate was well amalgamated for the purpose of obtaining a good but moveable contact, and a part round the axis was also prepared in a similar manner.

86. Conductors or electric collectors of copper and lead were constructed so as to come in contact with the edge of the copper disc (85.), or with other forms of plates hereafter to be described (101.). These conductors were about four inches long, one third of an inch wide, and one fifth of an inch thick; one end of each was slightly grooved, to allow of more exact adaptation to the somewhat convex edge of the plates, and then amalgamated. Copper wires, one sixteenth of an inch in thickness, attached, in the ordinary manner, by convolutions to the other ends of these conductors, passed away to the galvanometer.

87. The galvanometer was roughly made, yet sufficiently delicate in its indications. The wire was of copper covered with silk, and made sixteen or eighteen convolutions. Two sewing-needles were magnetized and fixed on to a stem of dried grass parallel to each other, but in opposite directions, and about half an inch apart; this system was suspended by a fibre of unspun silk, so that the lower needle should be between the convolutions of the multiplier, and the upper above them. The latter was by much the most powerful magnet, and gave terrestrial direction to the whole; fig. 8 represents the direction of the wire and of the needles when the instrument was placed in the magnetic meridian: the ends of the wires are marked A and B for convenient reference hereafter. The letters S and N designate the south and north ends of the needle when affected merely by terrestrial magnetism; the end N is therefore the marked pole (44.). The whole instrument was protected by a glass jar, and stood, as to position and distance relative to the large magnet, under the same circumstances as before (45.).

88. All these arrangements being made, the copper disc was adjusted as in fig. 7, the small magnetic poles being about half an inch apart, and the edge of the plate inserted about half their width between them. One of the galvanometer wires was passed twice or thrice loosely round the brass axis of the plate, and the other attached to a conductor (86.), which itself was retained by the hand in contact with the amalgamated edge of the disc at the part immediately between the magnetic poles. Under these circumstances all was quiescent, and the galvanometer exhibited no effect. But the instant the plate moved,

the galvanometer was influenced, and by revolving the plate quickly the needle could be deflected 90° or more.

89. It was difficult under the circumstances to make the contact between the conductor and the edge of the revolving disc uniformly good and extensive; it was also difficult in the first experiments to obtain a regular velocity of rotation: both these causes tended to retain the needle in a continual state of vibration; but no difficulty existed in ascertaining to which side it was deflected, or generally, about what line it vibrated. Afterwards, when the experiments were made more carefully, a permanent deflection of the needle of nearly 45° could be sustained.

90. Here therefore was demonstrated the production of a permanent current of electricity by ordinary magnets (57.).

91. When the motion of the disc was reversed, every other circumstance remaining the same, the galvanometer needle was deflected with equal power as before; but the deflection was on the opposite side, and the current of electricity evolved, therefore, the reverse of the former.

92. When the conductor was placed on the edge of the disc a little to the right or left, as in the dotted positions fig. 9, the current of electricity was still evolved, and in the same direction as at first (88. 91.). This occurred to a considerable distance, *i. e.* 50° or 60° on each side of the place of the magnetic poles. The current gathered by the conductor and conveyed to the galvanometer was of the same kind on both sides of the place of greatest intensity, but gradually diminished in force from that place. It appeared to be equally powerful at equal distances from the place of the magnetic poles, not being affected in that respect by the direction of the rotation. When the rotation of the disc was reversed, the direction of the current of electricity was reversed also; but the other circumstances were not affected.

93. On raising the plate, so that the magnetic poles were entirely hidden from each other by its intervention, (*a.* fig. 10,) the same effects were produced in the same order, and with equal intensity as before. On raising it still higher, so as to bring the place of the poles to *c*, still the effects were produced, and apparently with as much power as at first.

94. When the conductor was held against the edge as if fixed

to it, and with it moved between the poles, even though but for a few degrees, the galvanometer needle moved and indicated a current of electricity, the same as that which would have been produced if the wheel had revolved in the same direction, the conductor remaining stationary.

95. When the galvanometer connexion with the axis was broken, and its wires made fast to two conductors, both applied to the edge of the copper disc, then currents of electricity were produced, presenting more complicated appearances, but in perfect harmony with the above results. Thus, if applied as in fig. 11, a current of electricity through the galvanometer was produced; but if their place was a little shifted, as in fig. 12, a current in the contrary direction resulted; the fact being, that in the first instance the galvanometer indicated the difference between a strong current through A and a weak one through B, and in the second, of a weak current through A and a strong one through B (92.), and therefore produced opposite deflections.

96. So also when the two conductors were equidistant from the magnetic poles, as in fig. 13, no current at the galvanometer was perceived, whichever way the disc was rotated, beyond what was momentarily produced by irregularity of contact; because equal currents in the same direction tended to pass into both. But when the two conductors were connected with one wire, and the axis with the other wire, (fig. 14,) then the galvanometer showed a current according with the direction of rotation (91.); both conductors now acting consentaneously, and as a single conductor did before (88).

97. All these effects could be obtained when only one of the poles of the magnet was brought near to the plate; they were of the same kind as to direction, &c., but by no means so powerful.

98. All care was taken to render these results independent of the earth's magnetism, or of the mutual magnetism of the magnet and galvanometer needles. The contacts were made in the magnetic equator of the plate, and at other parts; the plate was placed horizontally, and the poles vertically; and other precautions were taken. But the absence of any interference of the kind referred to, was readily shown by the want of all effect when the disc was removed from the poles, or the

poles from the disc ; every other circumstance remaining the same.

99. The *relation of the current* of electricity produced, to the magnetic pole, to the direction of rotation of the plate, &c. &c., may be expressed by saying, that when the unmarked pole (44. 84.) is beneath the edge of the plate, and the latter revolves horizontally, screw-fashion, the electricity which can be collected at the edge of the plate nearest to the pole is positive. As the pole of the earth may mentally be considered the unmarked pole, this relation of the rotation, the pole, and the electricity evolved, is not difficult to remember. Or if, in fig. 15, the circle represent the copper disc revolving in the direction of the arrows, and *a* the outline of the unmarked pole placed beneath the plate, then the electricity collected at *b* and the neighbouring parts is positive, whilst that collected at the centre *c* and other parts is negative (88.). The currents in the plate are therefore from the centre by the magnetic poles towards the circumference.

100. If the marked pole be placed above, all other things remaining the same, the electricity at *b*, fig. 15, is still positive. If the marked pole be placed below, or the unmarked pole above, the electricity is reversed. If the direction of revolution in any case is reversed, the electricity is also reversed.

101. It is now evident that the rotating plate is merely another form of the simpler experiment of passing a piece of metal between the magnetic poles in a rectilinear direction, and that in such cases currents of electricity are produced at right angles to the direction of the motion, and crossing it at the place of the magnetic pole or poles. This was sufficiently shown by the following simple experiment : A piece of copper plate one-fifth of an inch thick, one inch and a half wide, and twelve inches long, being amalgamated at the edges, was placed between the magnetic poles, whilst the two conductors from the galvanometer were held in contact with its edges ; it was then drawn through between the poles of the conductors in the direction of the arrow, fig. 16 ; immediately the galvanometer needle was deflected, its north or marked end passed eastward, indicating that the wire A received negative and the wire B positive electricity ; and as the marked pole was above,

the result is in perfect accordance with the effect obtained by the rotatory plate (99.).

102. On reversing the motion of the plate, the needle at the galvanometer was deflected in the opposite direction, showing an opposite current.

103. To render evident the character of the electrical current existing in various parts of the moving copper plate, differing in their relation to the inducing poles, one collector (86.) only was applied at the part to be examined near to the pole, the other being connected with the end of the plate as the most neutral place: the results are given at figs. 17—20, the marked pole being above the plate. In fig. 17, B received positive electricity; but the plate moving in the same direction, it received on the opposite side, fig. 18, negative electricity; reversing the motion of the latter, as in fig. 20, B received positive electricity; or reversing the motion of the first arrangement, that of fig. 17 to fig. 19, B received negative electricity.

104. When the plates were previously removed sideways from between the magnets, as in fig. 21, so as to be quite out of the polar axis, still the same effects were produced, though not so strongly.

105. When the magnetic poles were in contact, and the copper plate was drawn between the conductors near to the place, there was but very little effect produced. When the poles were opened by the width of a card, the effect was somewhat more, but still very small.

106. When an amalgamated copper wire, one eighth of an inch thick, was drawn through between the conductors and poles (101.), it produced a very considerable effect, though not so much as the plates.

107. If the conductors were held permanently against any particular parts of the copper plates, and carried between the magnetic poles with them, effects the same as those described were produced, in accordance with the results obtained with the revolving disc (94.).

108. On the conductors being held against the ends of the plates, and the latter then passed between the magnetic poles, in a direction transverse to their length, the same effects were

produced (fig. 22.). The parts of the plates towards the end may be considered either as mere conductors, or as portions of metal in which the electrical current is excited, according to their distance and the strength of the magnet; but the results were in perfect harmony with those before obtained. The effect was as strong as when the conductors were held against the sides of the plate (101.).

109. When a mere wire, connected with the galvanometer so as to form a complete circuit, was passed through between the poles, the galvanometer was affected; and upon moving the wire to and fro, so as to make the alternate impulses produced correspond with the vibrations of the needle, the latter could be increased to 20° or 30° on each side the magnetic meridian.

110. Upon connecting the ends of a plate of metal with the galvanometer wires, and then carrying it between the poles from end to end (as in fig. 23.), in either direction, no effect whatever was produced upon the galvanometer. But the moment the motion became transverse, the needle was deflected.

111. These effects were also obtained from *electro-magnetic poles*, resulting from the use of copper helices or spirals, either alone or with iron cores (34. 54.). The directions of the motions were precisely the same; but the action was much greater when the iron cores were used, than without.

112. When a flat spiral was passed through edgewise between the poles, a curious action of the galvanometer resulted; the needle first went strongly one way, but then suddenly stopped, as if it struck against some solid obstacle, and immediately returned. If the spiral were passed through from above downwards, or from below upwards, still the motion of the needle was in the same direction, then suddenly stopped, and then was reversed. But on turning the spiral half-way round, *i. e.* edge for edge, then the directions of the motions were reversed, but still were suddenly interrupted and inverted as before. This double action depends upon the halves of the spiral (divided by a line passing through its centre perpendicular to the direction of its motion) acting in opposite directions; and the reason why the needle went to the same side, whether the spiral passed by the poles in the one or the other direction, was the circumstance, that upon changing the motion, the di-

rection of the wires in the approaching half of the spiral was changed also. The effects, curious as they appear when witnessed, are immediately referable to the action of single wires (40. 109.).

113. Although the experiments with the revolving plate, wires, and plates of metal, were first successfully made with the large magnet belonging to the Royal Society, yet they were all ultimately repeated with a couple of bar magnets two feet long, one inch and a half wide, and half an inch thick; and, by rendering the galvanometer (87.) a little more delicate, with the most striking results. Ferro-electro-magnets, as those of Moll, Henry, &c. (57.), are very powerful. It is very essential, when making experiments on different substances, that thermo-electric effects (produced by contact of the fingers, &c.) be avoided, or at least appreciated and accounted for; they are easily distinguished by their permanency, and their independence of the magnets, or of the direction of the motion.

114. The relation which holds between the magnetic pole, the moving wire or metal, and the direction of the current evolved, *i. e.* the law which governs the evolution of electricity by magneto-electric induction, is very simple, although rather difficult to express. If in fig. 24. PN represent a horizontal wire passing by a marked magnetic pole, so that the direction of its motion shall coincide with the curved line proceeding from below upwards; or if its motion parallel to itself be in a line tangential to the curved line, but in the general direction of the arrows; or if it pass the pole in other directions, but so as to cut the magnetic curves* in the same general direction, or on the same side as they would be cut by the wire if moving along the dotted curved line;—then the current of electricity in the wire is from P to N. If it be carried in the reverse directions, the electric current will be from N to P. Or if the wire be in the vertical position, figured P' N', and it be carried in similar directions, coinciding with the dotted horizontal curve so far, as to cut the magnetic curves on the same side with it, the current will be from P' to N'. If the wire be considered a tangent to the curved surface of the cylindrical mag-

* By magnetic curves I mean the lines of magnetic forces, however modified by the juxtaposition of poles, which would be depicted by iron filings; or those to which a very small magnetic needle would form a tangent.

net, and it be carried round that surface into any other position, or if the magnet itself be revolved on its axis, so as to bring any part opposite to the tangential wire,—still, if afterwards the wire be moved in the directions indicated, the current of electricity will be from P to N; or if it be moved in the opposite direction, from N to P; so that as regards the motions of the wire past the pole, they may be reduced to two, directly opposite to each other, one of which produces a current from P to N, and the other from N to P.

115. The same holds true of the unmarked pole of the magnet, except that if it be substituted for the one in the figure, then, as the wires are moved in the direction of the arrows, the current of electricity would be from N to P, and when they move in the reverse direction, from P to N.

116. Hence the current of electricity which is excited in metal when moving in the neighbourhood of a magnet, depends for its direction altogether upon the relation of the metal to the resultant of magnetic action, or to the magnetic curves, and may be expressed in a popular way thus: Let A B (fig. 25.) represent a cylinder magnet, A being the marked pole, and B the unmarked pole; let P N be a silver knife-blade resting across the magnet with its edge upward, and with its marked or notched side towards the pole A; then in whatever direction or position this knife be moved edge foremost, either about the marked or the unmarked pole, the current of electricity produced will be from P to N, provided the intersected curves proceeding from A abut upon the notched surface of the knife, and those from B upon the unnotched side. Or if the knife be moved with its back foremost, the current will be from N to P in every possible position and direction, provided the intersected curves abut on the same surfaces as before. A little model is easily constructed, by using a cylinder of wood for a magnet, a flat piece for the blade, and a piece of thread connecting one end of the cylinder with the other, and passing through a hole in the blade, for the magnetic curves: this readily gives the result of any possible direction.

117. When the wire under induction is passing by an electromagnetic pole, as for instance one end of a copper helix traversed by the electric current (34.), the direction of the current in the approaching wire is the same with that of the current

in the parts or sides of the spirals nearest to it, and in the re-
ceding wire the reverse of that in the parts nearest to it.

118. All these results show that the power of inducing electric currents is circumferentially exerted by a magnetic resultant or axis of power, just as circumferential magnetism is dependent upon and is exhibited by an electric current.

119. The experiments described combine to prove that when a piece of metal (and the same may be true of all conducting matter (213.)) is passed either before a single pole, or between the opposite poles of a magnet, or near electro-magnetic poles, whether ferruginous or not, electrical currents are produced across the metal transverse to the direction of motion; and which therefore, in Arago's experiments, will approximate towards the direction of radii. If a single wire be moved like the spoke of a wheel near a magnetic pole, a current of electricity is determined through it from one end towards the other. If a wheel be imagined, constructed of a great number of these radii, and this revolved near the pole, in the manner of the copper disc (85.), each radius will have a current produced in it as it passes by the pole. If the radii be supposed to be in contact laterally, a copper disc results, in which the directions of the currents will be generally the same, being modified only by the reaction which can take place between the particles, now that they are in metallic contact.

120. Now that the existence of these currents is known, Arago's phenomena may be accounted for without considering them as due to the formation in the copper of a pole of the opposite kind to that approximated, surrounded by a diffuse polarity of the same kind (82.); neither is it essential that the plate should acquire and lose its state in a finite time; nor on the other hand does it seem necessary that any repulsive force should be admitted as the cause of the rotation (82.).

121. The effect is precisely of the same kind as the electro-magnetic rotations which I had the good fortune to discover some years ago*. According to the experiments then made, which have since been abundantly confirmed, if a wire (P N fig. 26.) be connected with the positive and negative ends of a voltaic battery, so that the positive electricity shall pass from

* Quarterly Journal of Science, vol. xii. pp. 74, 186, 416, 283.

P to N, and a marked magnetic pole N be placed near the wire between it and the spectator, the pole will move in a direction tangential to the wire, *i. e.* towards the right, and the wire will move tangentially towards the left, according to the directions of the arrows. This is exactly what takes place in the rotation of a plate beneath a magnetic pole; for let N (fig. 27.) be a marked pole above the circular plate, the latter being rotated in the direction of the arrow: immediately currents of positive electricity set from the central parts in the general direction of the radii by the pole to the parts of the circumference *a* on the other side of that pole (99. 119.), and are therefore exactly in the same relation to it as the current in the wire (P N, fig. 26), and therefore the pole in the same manner moves to the right hand.

122. If the rotation of the disc be reversed, the electric currents are reversed (91.), and the pole therefore moves to the left hand. If the contrary pole be employed, the effects are the same, *i. e.* in the same direction, because currents of electricity, the reverse of those described, are produced, and by reversing both poles and currents, the visible effects remain unchanged. In whatever position the axis of the magnet be placed, provided the same pole be applied to the same side of the plate, the electric current produced is in the same direction, in consistency with the law already stated (114, &c.); and thus every circumstance regarding the direction of the motion may be explained.

123. These currents are *discharged or return* in the parts of the plate on each side of and more distant from the place of the pole, where, of course, the magnetic induction is weaker: and when the collectors are applied, and a current of electricity is carried away to the galvanometer (88.), the deflection there is merely a repetition, by the same current or part of it, of the effect of rotation in the magnet over the plate itself.

124. It is under the point of view just put forth that I have ventured to say it is not necessary that the plate should acquire and lose its state in a finite time (120.); for if it were possible for the current to be fully developed the instant *before* it arrived at its state of nearest approximation to the vertical pole of the magnet, instead of opposite to or a little beyond it, still the relative motion of the pole and plate would be the

same, the resulting force being in fact tangential instead of direct.

125. But it is possible (though not necessary for the rotation) that *time* may be required for the development of the maximum current in the plate, in which case the resultant of all the forces would be in advance of the magnet when the plate is rotated, or in the rear of the magnet when the latter is rotated, and many of the effects with pure electro-magnetic poles tend to prove this is the case. Then, the tangential force may be resolved into two others, one parallel to the plane of rotation, and the other perpendicular to it: the former would be the force exerted in making the plate revolve with the magnet, or the magnet with the plate; the latter would be a repulsive force, and is probably that, the effects of which M. Arago has also discovered (82.).

126. The extraordinary circumstance accompanying this action which has seemed so inexplicable, namely, the cessation of all phenomena when the magnet and metal are brought to rest, now receives a full explanation (82.); for then the electrical currents which cause the motion cease altogether.

127. All the effects of solution of metallic continuity, and the consequent diminution of power described by Messrs. Babbage and Herschel*, now receive their natural explanation, as well also as the resumption of power when the cuts were filled up by metallic substances, which, though conductors of electricity, were themselves very deficient in the power of influencing magnets. And new modes of cutting the plate may be devised, which shall almost entirely destroy its power. Thus, if a copper plate (81.) be cut through at about a fifth or sixth of its diameter from the edge, so as to separate a ring from it, and this ring be again fastened on, but with a thickness of paper intervening (fig. 29), and if Arago's experiment be made with this compound plate so adjusted that the section shall continually travel opposite the pole, it is evident that the magnetic currents will be greatly interfered with, and the plate probably lose much of its effect †.

* Philosophical Transactions, 1825, p. 481.

† This experiment has actually been made by Mr. Christie, with the results here described, and is recorded in the Philosophical Transactions for 1827, p. 82.

An elementary result of this kind was obtained by using two pieces of thick copper, shaped as in fig. 28. When the two neighbouring edges were amalgamated and put together, and the arrangement passed between the poles of the magnet, in a direction parallel to these edges, a current was urged through the wires attached to the outer angles, and the galvanometer became strongly affected; but when a single film of paper was interposed, and the experiment repeated, no sensible effect could be produced.

128. A section of this kind could not interfere much with the induction of magnetism, supposed to be of the nature ordinarily received by iron.

129. The effect of rotation or deflection of the needle, which M. Arago obtained by ordinary magnets, M. Ampère succeeded in procuring by electro-magnets. This is perfectly in harmony with the results relative to volta-electric and magneto-electric induction described in this paper. And by using flat spirals of copper wire, through which electric currents were sent, in place of ordinary magnetic poles (111.), sometimes applying a single one to one side of the rotating plate, and sometimes two to opposite sides, I obtained the induced currents of electricity from the plate itself, and could lead them away to, and ascertain their existence by, the galvanometer.

130. The cause which has now been assigned for the rotation in Arago's experiment, namely, the production of electrical currents, seems abundantly sufficient in all cases where the metals, or perhaps even other conductors, are concerned; but with regard to such bodies as glass, resins, and, above all, gases, it seems impossible that currents of electricity, capable of producing these effects, should be generated in them. Yet Arago found that the effects in question were produced by these and by all bodies tried (81.). Messrs. Babbage and Herschel, it is true, did not observe them with any substance not metallic, except carbon, in a highly conducting state (82.). Mr. Harris has ascertained their occurrence with wood, marble, freestone and annealed glass, but obtained no effect with sulphuric acid and saturated solution of sulphate of iron, although these are better conductors of electricity than the former substances.

131. Future investigations will no doubt explain these diffi-

eulties, and decide the point whether the retarding or dragging action spoken of is always simultaneous with electric currents*. The existence of the action in metals, only whilst the currents exist, *i. e.* whilst motion is given (82. 88.), and the explication of the repulsive action observed by M. Arago (82. 125.), are powerful reasons for referring it to this cause; but it may be combined with others which occasionally act alone.

132. Copper, iron, tin, zinc, lead, mercury, and all the metals tried, produced electrical currents when passed between the magnetic poles: the mercury was put into a glass tube for the purpose. The dense carbon deposited in coal gas retorts, also produced the current, but ordinary charcoal did not. Neither could I obtain any sensible effects with brine, sulphuric acid, saline solutions, &c., whether rotated in basins, or inclosed in tubes and passed between the poles.

133. I have never been able to produce any sensation upon the tongue by the wires connected with the conductors applied to the edges of the revolving plate (88.) or slips of metal (101.). Nor have I been able to heat a fine platina wire, or produce a spark, or convulse the limbs of a frog. I have failed also to produce any chemical effects by electricity thus evolved (22. 56.).

134. As the electric current in the revolving copper plate occupies but a small space, proceeding by the poles and being discharged right and left at very small distances comparatively (123.); and as it exists in a thick mass of metal possessing almost the highest conducting power of any, and consequently offering extraordinary facility for its production and discharge; and as, notwithstanding this, considerable currents may be drawn off which can pass through narrow wires, forty, fifty, sixty, or even one hundred feet long; it is evident that the current existing in the plate itself must be a very powerful one, when the rotation is rapid and the magnet strong. This is also abundantly proved by the obedience and readiness with which a magnet ten or twelve pounds in weight follows the

* Experiments which I have since made convince me that this particular action is always due to the electrical currents formed; and they supply a test by which it may be distinguished from the action of ordinary magnetism, or any other cause, including those which are mechanical or irregular, producing similar effects (254.).

motion of the plate and will strongly twist up the cord by which it is suspended.

135. Two rough trials were made with the intention of constructing *magneto-electric machines*. In one, a ring one inch and a half broad and twelve inches external diameter, cut from a thick copper plate, was mounted so as to revolve between the poles of the magnet and represent a plate similar to those formerly used (101.), but of interminable length; the inner and outer edges were amalgamated, and the conductors applied one to each edge, at the place of the magnetic poles. The current of electricity evolved did not appear by the galvanometer to be stronger, if so strong, as that from the circular plate (88.).

136. In the other, small thick discs of copper or other metal, half an inch in diameter, were revolved rapidly near to the poles, but with the axis of rotation out of the polar axis; the electricity evolved was collected by conductors applied as before to the edges (86.). Currents were procured, but of strength much inferior to that produced by the circular plate.

137. The latter experiment is analogous to those made by Mr. Barlow with a rotating iron shell, subject to the influence of the earth*. The effects obtained by him have been referred by Messrs. Babbage and Herschel to the same cause as that considered as influential in Arago's experiment†; but it would be interesting to know how far the electric current which might be produced in the experiment would account for the deflexion of the needle. The mere inversion of a copper wire six or seven times near the poles of the magnet, and isochronously with the vibrations of the galvanometer needle connected with it, was sufficient to make the needle vibrate through an arc of 60° or 70°. The rotation of a copper shell would perhaps decide the point, and might even throw light upon the more permanent, though somewhat analogous effects obtained by Mr. Christie.

138. The remark which has already been made respecting iron (66.), and the independence of the ordinary magnetical phenomena of that substance, and the phenomena now described of magneto-electric induction in that and other metals, was fully confirmed by many results of the kind detailed in this

* Philosophical Transactions, 1825, p. 317.

† Ibid. 1825, p. 485.

section. When an iron plate similar to the copper one formerly described (101.) was passed between the magnetic poles, it gave a current of electricity like the copper plate, but decidedly of less power; and in the experiments upon the induction of electric currents (9.), no difference in the kind of action between iron and other metals could be perceived. The power therefore of an iron plate to drag a magnet after it, or to intercept magnetic action, should be carefully distinguished from the similar power of such metals as silver, copper, &c. &c., inasmuch as in the iron by far the greater part of the effect is due to what may be called ordinary magnetic action. There can be no doubt that the cause assigned by Messrs. Babbage and Herschel in explanation of Arago's phenomena is the true one, when iron is the metal used.

139. The very feeble powers which were found by those philosophers to belong to bismuth and antimony, when moving, or affecting the suspended magnet, and which has been confirmed by Mr. Harris, seem at first disproportionate to their conducting powers; whether it be so or not must be decided by future experiment (73.)*. These metals are highly crystalline, and probably conduct electricity with different degrees of facility in different directions; and it is not unlikely that where a mass is made up of a number of crystals heterogeneously associated, an effect approaching to that of actual division may occur (127.); or the currents of electricity may become more suddenly deflected at the confines of similar crystalline arrangements, and so be more readily and completely discharged within the mass.

* I have since been able to explain these differences, and prove, with several metals, that the effect is in the order of the conducting power; for I have been able to obtain, by magneto-electric induction, currents of electricity which are proportionate in strength to the conducting power of the bodies experimented with (211.).

Royal Institution, November 1831.

Note.—In consequence of the long period which has intervened between the reading and printing of the foregoing paper, accounts of the experiments have been dispersed, and, through a letter of my own to M. Hachette, have reached France and Italy. That letter was translated (with some errors), and read to the Academy of Sciences at Paris, 26th December, 1831. A copy of it in *Le Temps* of the 28th December quickly reached Signor Nobili, who, with Signor

Antinori, immediately experimented upon the subject, and obtained many of the results mentioned in my letter; others they could not obtain or understand, because of the brevity of my account. These results by Signori Nobili and Antinori have been embodied in a paper dated 31st January 1832, and printed and published in the number of the *Antologia* dated November 1831, (according at least to the copy of the paper kindly sent me by Signor Nobili). It is evident the work could not have been then printed; and though Signor Nobili, in his paper, has inserted my letter as the text of his experiments, yet the circumstance of back date has caused many here who have heard of Nobili's experiments by report only, to imagine his results were anterior to, instead of being dependent upon, mine.

I may be allowed under these circumstances to remark, that I experimented on this subject several years ago, and have published results. (See Quarterly Journal of Science for July 1825, p. 338.) The following also is an extract from my note-book, dated November 28, 1825: "Experiments on induction by connecting wire of voltaic battery:—a battery of four troughs, ten pairs of plates, each arranged side by side—the poles connected by a wire about four feet long, parallel to which was another similar wire separated from it only by two thicknesses of paper, the ends of the latter were attached to a galvanometer:—exhibited no action, &c. &c. &c.—Could not in any way render any induction evident from the connecting wire." The cause of failure at that time is now evident (79).—M. F., April 1832.

SECOND SERIES.

THE BAKERIAN LECTURE.

§ 5. *Terrestrial Magneto-electric Induction.* § 6. *Force and Direction of Magneto-electric Induction generally.*

Read January 12, 1832.

§ 5. *Terrestrial Magneto-electric Induction.*

140. WHEN the general facts described in the former paper were discovered, and the *law* of magneto-electric induction relative to direction was ascertained (114.), it was not difficult to perceive that the earth would produce the same effect as a magnet, and to an extent that would, perhaps, render it available in the construction of new electrical machines. The following are some of the results obtained in pursuance of this view.

141. The hollow helix already described (6.) was connected with a galvanometer by wires eight feet long; and the soft iron cylinder (34.) after being heated red hot and slowly cooled, to remove all traces of magnetism, was put into the helix so as to project equally at both ends, and fixed there. The combined helix and bar were held in the magnetic direction or line of dip, and (the galvanometer needle being motionless) were then inverted, so that the lower end should become the upper, but the whole still correspond to the magnetic direction; the needle was immediately deflected. As the latter returned to its first position, the helix and bar were again inverted; and by doing this two or three times, making the inversions and vibrations to coincide, the needle swung through an arc of 150° or 160° .

142. When one end of the helix, which may be called A, was uppermost at first (B end consequently being below), then it mattered not in which direction it proceeded during the inversion, whether to the right hand or left hand, or through any other course; still the galvanometer needle passed in the same direction. Again, when B end was uppermost, the inversion of the helix and bar in any direction always caused the needle

to be deflected one way; that way being the opposite to the course of the deflection in the former case.

143. When the helix with its iron core in any given position was inverted, the effect was as if a magnet with its marked pole downwards had been introduced from above into the inverted helix. Thus, if the end B were upwards, such a magnet introduced from above would make the marked end of the galvanometer needle pass west. Or the end B being downwards, and the soft iron in its place, inversion of the whole produced the same effect.

144. When the soft iron bar was taken out of the helix and inverted in various directions within four feet of the galvanometer, not the slightest effect upon it was produced.

145. These phenomena are the necessary consequence of the inductive magnetic power of the earth, rendering the soft iron cylinder a magnet with its marked pole downwards. The experiment is analogous to that in which two bar magnets were used to magnetize the same cylinder in the same helix (36.), and the inversion of position in the present experiment is equivalent to a change of the poles in that arrangement. But the result is not less an instance of the evolution of electricity by means of the magnetism of the globe.

146. The helix alone was then held permanently in the magnetic direction, and the soft iron cylinder afterwards introduced; the galvanometer needle was instantly deflected; by withdrawing the cylinder as the needle returned, and continuing the two actions simultaneously, the vibrations soon extended through an arc of 180° . The effect was precisely the same as that obtained by using a cylinder magnet with its marked pole downwards; and the direction of motion, &c. was perfectly in accordance with the results of former experiments obtained with such a magnet (39.). A magnet in that position being used, gave the same deflection, but stronger. When the helix was put at right angles to the magnetic direction or dip, then the introduction or removal of the soft iron cylinder produced no effect at the needle. Any inclination to the dip gave results of the same kind as those already described, but increasing in strength as the helix approximated to the direction of the dip.

147. A cylinder magnet, although it has great power of affecting the galvanometer when moving into or out of the helix,

has no power of continuing the deflection (39.); and therefore, though left in, still the magnetic needle comes to its usual place of rest. But upon repeating (with the magnet) the experiment of inversion in the direction of the dip (141.), the needle was affected as powerfully as before; the disturbance of the magnetism in the steel magnet, by the earth's inductive force upon it, being thus shown to be nearly, if not quite, equal in amount and rapidity to that occurring in soft iron. It is probable that in this way magneto-electrical arrangements may become very useful in indicating the disturbance of magnetic forces, where other means will not apply; for it is not the whole magnetic power which produce the visible effect, but only the difference due to the disturbing causes.

148. These favourable results led me to hope that the direct magneto-electric induction of the earth might be rendered sensible; and I ultimately succeeded in obtaining the effect in several ways. When the helix just referred to (141. 6.) was placed in the magnetic dip, but without any cylinder of iron or steel, and was then inverted, a feeble action at the needle was observed. Inverting the helix ten or twelve times, and at such periods that the deflecting forces exerted by the currents of electricity produced in it should be added to the momentum of the needle (39.), the latter was soon made to vibrate through an arc of 80° or 90° . Here, therefore, currents of electricity were produced by the direct inductive power of the earth's magnetism, without the use of any ferruginous matter, and upon a metal not capable of exhibiting any of the ordinary magnetic phenomena. The experiment in everything represents the effects produced by bringing the same helix to one or both poles of any powerful magnet (50.).

149. Guided by the law already expressed (114.), I expected that all the electric phenomena of the revolving metal plate could now be produced without any other magnet than the earth. The plate so often referred to (85.) was therefore fixed so as to rotate in a horizontal plane. The magnetic curves of the earth (114. *note*), *i. e.* the dip, passes through this plane at angles of about 70° , which it was expected would be an approximation to perpendicularity, quite enough to allow of magneto-electric induction sufficiently powerful to produce a current of electricity.

150. Upon rotation of the plate, the currents ought, according to the law (114. 121.), to tend to pass in the direction of the radii, through *all* parts of the plate, either from the centre to the circumference, or from the circumference to the centre, as the direction of the rotation of the plate was one way or the other. One of the wires of the galvanometer was therefore brought in contact with the axis of the plate, and the other attached to a leaden collector or conductor (86.), which itself was placed against the amalgamated edge of the disc. On rotating the plate there was a distinct effect at the galvanometer needle; on reversing the rotation, the needle went in the opposite direction; and by making the action of the plate coincide with the vibrations of the needle, the arc through which the latter passed soon extended to half a circle.

151. Whatever part of the edge of the plate was touched by the conductor, the electricity was the same, provided the direction of rotation continued unaltered.

152. When the plate revolved *screw-fashion*, or as the hands of a watch, the current of electricity (150.) was from the centre to the circumference; when the direction of rotation was *unscrew*, the current was from the circumference to the centre. These directions are the same with those obtained when the unmarked pole of a magnet was placed beneath the revolving plate (99.).

153. When the plate was in the magnetic meridian, or in any other plane *coinciding* with the magnetic dip, then its rotation produced no effect upon the galvanometer. When inclined to the dip but a few degrees, electricity began to appear upon rotation. Thus when standing upright in a plane perpendicular to the magnetic meridian, and when consequently its own plane was inclined only about 20° to the dip, revolution of the plate evolved electricity. As the inclination was increased, the electricity became more powerful until the angle formed by the plane of the plate with the dip was 90° , when the electricity for a given velocity of the plate was a maximum.

154. It is a striking thing to observe the revolving copper plate become thus a *new electrical machine*; and curious results arise on comparing it with the common machine. In the one, the plate is of the best non-conducting substance that can be applied; in the other, it is the most perfect conductor; in the one,

insulation is essential ; in the other it is fatal. In comparison of the quantities of electricity produced, the metal machine does not at all fall below the glass one ; for it can produce a constant current capable of deflecting the galvanometer needle, whereas the latter cannot. It is quite true that the force of the current thus evolved has not as yet been increased so as to render it available in any of our ordinary applications of this power ; but there appears every reasonable expectation that this may hereafter be effected ; and probably by several arrangements. Weak as the current may seem to be, it is as strong as, if not stronger than, any thermo-electric current ; for it can pass fluids (23.), agitate the animal system, and in the case of an electro-magnet has produced sparks (32.).

155. A disc of copper, one fifth of an inch thick and only one inch and a half in diameter, was amalgamated at the edge ; a square piece of sheet lead (copper would have been better) of equal thickness had a circular hole cut in it, into which the disc loosely fitted ; a little mercury completed the metallic communication of the disc and its surrounding ring ; the latter was attached to one of the galvanometer wires, and the other wire dipped into a little metallic cup containing mercury, fixed upon the top of the copper axis of the small disc. Upon rotating the disc in a horizontal plane, the galvanometer needle could be affected, although the earth was the only magnet employed, and the radius of the disc but three quarters of an inch ; in which space only the current was excited.

156. On putting the pole of a magnet under the revolving disc, the galvanometer needle could be permanently deflected.

157. On using copper wires one sixth of an inch in thickness instead of the smaller wires (86.) hitherto constantly employed, far more powerful effects were obtained. Perhaps if the galvanometer had consisted of fewer turns of thick wire instead of many convolutions of thinner, more striking effects would have been produced.

158. One form of apparatus which I purpose having arranged, is to have several discs superposed ; the discs are to be metallically connected, alternately at the edges and at the centres, by means of mercury ; and are then to be revolved alternately in opposite directions, *i. e.* the first, third, fifth, &c. to the right hand, and the second, fourth, sixth, &c. to the

left hand; the whole being placed so that the discs are perpendicular to the dip, or intersect most directly the magnetic curves of powerful magnets. The electricity will be from the centre to the circumference in one set of discs, and from the circumference to the centre in those on each side of them; thus the action of the whole will conjoin to produce one combined and more powerful current.

159. I have rather, however, been desirous of discovering new facts and new relations dependent on magneto-electric induction, than of exalting the force of those already obtained; being assured that the latter would find their full development hereafter.

160. I referred in my former paper to the probable influence of terrestrial magneto-electric induction (137.) in producing, either altogether or in part, the phenomena observed by Messrs. Christie and Barlow*, whilst revolving ferruginous bodies; and especially those observed by the latter when rapidly rotating an iron shell, which were by that philosopher referred to a change in the ordinary disposition of the magnetism of the ball. I suggested also that the rotation of a copper globe would probably insulate the effects due to electric currents from those due to mere derangement of magnetism, and throw light upon the true nature of the phenomena.

161. Upon considering the law already referred to (114.), it appeared impossible that a metallic globe could revolve under natural circumstances, without having electric currents produced within it, circulating round the revolving globe in a plane at right angles to the plane of revolution, provided its axis of rotation did not coincide with the dip; and it appeared that the current would be most powerful when the axis of revolution was perpendicular to the dip of the needle: for then all those parts of the ball below a plane passing through its centre and perpendicular to the dip, would in moving cut the magnetic curves in one direction, whilst all those parts above that plane would intersect them in the other direction: currents therefore would exist in these moving parts, proceeding from one pole of rotation to the other; but the currents above would

* Christie, Phil. Trans. 1825, pp. 58, 347, &c. Barlow, Phil. Trans. 1825, p. 317.

be in the reverse direction to those below, and in conjunction with them would produce a continued circulation of electricity.

162. As the electric currents are nowhere interrupted in the ball, powerful effects were expected, and I endeavoured to obtain them with simple apparatus. The ball I used was of brass; it had belonged to an old electrical machine, was hollow, thin (too thin), and four inches in diameter; a brass wire was screwed into it, and the ball either turned in the hand by the wire, or sometimes, to render it more steady, supported by its wire in a notched piece of wood, and motion again given by the hand. The ball gave no signs of magnetism when at rest.

163. A compound magnetic needle was used to detect the currents. It was arranged thus: a sewing-needle had the head and point broken off, and was then magnetized; being broken in halves, the two magnets thus produced were fixed on a stem of dried grass, so as to be perpendicular to it, and about four inches asunder; they were both in one plane, but their similar poles in contrary directions. The grass was attached to a piece of unspun silk about six inches long, the latter to a stick passing through a cork in the mouth of a cylindrical jar; and thus a compound arrangement was obtained, perfectly sheltered from the motion of the air, but little influenced by the magnetism of the earth, and yet highly sensible to magnetic and electric forces, when the latter were brought into the vicinity of the one or the other needle.

164. Upon adjusting the needles to the plane of the magnetic meridian; arranging the ball on the outside of the glass jar to the west of the needles, and at such a height that its centre should correspond horizontally with the upper needle, whilst its axis was in the plane of the magnetic meridian, but perpendicular to the dip; and then rotating the ball, the needle was immediately affected. Upon inverting the direction of rotation, the needle was again affected, but in the opposite direction. When the ball revolved from east over to west, the marked pole went eastward; when the ball revolved in the opposite direction, the marked pole went westward or towards the ball. Upon placing the ball to the east of the needles, still the needle was deflected in the same way; *i. e.* when the ball revolved from east over to west, the marked pole went eastward (or to-

wards the ball) ; when the rotation was in the opposite direction, the marked pole went westward.

165. By twisting the silk of the needles, the latter were brought into a position perpendicular to the plane of the magnetic meridian ; the ball was again revolved, with its axis parallel to the needles ; the upper was affected as before, and the deflection was such as to show that both here and in the former case the needle was influenced solely by currents of electricity existing in the brass globe.

166. If the upper part of the revolving ball be considered as a wire moving from east to west, over the unmarked pole of the earth, the current of electricity in it should be from north to south (99. 114. 150.) ; if the under part be considered as a similar wire, moving from west to east over the same pole, the electric current should be from south to north ; and the circulation of electricity should therefore be from north above to south, and below back to north, in a metal ball revolving from east above to west in these latitudes. Now these currents are exactly those required to give the directions of the needle in the experiments just described ; so that the coincidence of the theory from which the experiments were deduced with the experiments themselves, is perfect.

167. Upon inclining the axis of rotation considerably, the revolving ball was still found to affect the magnetic needle ; and it was not until the angle which it formed with the magnetic dip was rendered small, that its effects, even upon this apparatus, were lost (153.). When revolving with its axis parallel to the dip, it is evident that the globe becomes analogous to the copper plate ; electricity of one kind might be collected at its equator, and of the other kind at its poles.

168. A current in the ball, such as that described above (161.), although it ought to deflect a needle the same way whether it be to the right or the left of the ball and of the axis of rotation, ought to deflect it the contrary way when above or below the ball ; for then the needle is, or ought to be, acted upon in a contrary direction by the current. This expectation was fulfilled by revolving the ball beneath the magnetic needle, the latter being still inclosed in its jar. When the ball was revolved from east over to west, the marked pole of the needle, instead of passing eastward, went westward ;

and when revolved from west over to east, the marked pole went eastward.

169. The deflections of the magnetic needle thus obtained with a brass ball are exactly in the same direction as those observed by Mr. Barlow in the revolution of the iron shell; and from the manner in which iron exhibits the phenomena of magneto-electric induction like any other metal, and distinct from its peculiar magnetic phenomena (132.), it is impossible but that electric currents must have been excited, and become active in those experiments. What proportion of the whole effect obtained is due to this cause, must be decided by a more elaborate investigation of all the phenomena.

170. These results, in conjunction with the general law, before stated (114.) suggested an experiment of extreme simplicity, which yet, on trial, was found to answer perfectly. The exclusion of all extraneous circumstances and complexity of arrangement, and the distinct character of the indications afforded, render this single experiment an epitome of nearly all the facts of magneto-electric induction.

171. A piece of common copper wire, about eight feet long, and one twentieth of an inch in thickness, had one of its ends fastened to one of the terminations of the galvanometer wire, and the other end to the other termination; thus it formed an endless continuation of the galvanometer wire: it was then roughly adjusted into the shape of a rectangle, or rather of a loop, the upper part of which could be carried to and fro over the galvanometer, whilst the lower part, and the galvanometer attached to it, remained steady (Plate II. fig. 30.). Upon moving this loop over the galvanometer from right to left, the magnetic needle was immediately deflected; upon passing the loop back again, the needle passed in the contrary direction to what it did before; upon repeating these motions of the loop in accordance with the vibrations of the needle (39.), the latter soon swung through 90° or more.

172. The relation of the current of electricity produced in the wire, to its motion, may be understood by supposing the convolutions of the galvanometer away, and the wire arranged as a rectangle, with its lower edge horizontal and in the plane of the magnetic meridian, and a magnetic needle suspended above and over the middle part of this edge, and directed by

the earth (fig. 30.). On passing the upper part of the rectangle from west to east in the position represented by the dotted line, the marked pole of the magnetic needle went west; the electric current was therefore from north to south in the part of the wire passing under the needle, and from south to north in the moving or upper part of the parallelogram. On passing the upper part of the rectangle from east to west over the galvanometer, the marked pole of the needle went east, and the current of electricity was therefore the reverse of the former.

173. When the rectangle was arranged in a plane east and west, and the magnetic needle made parallel to it, either by the torsion of its suspension thread or the action of a magnet, still the general effects were the same. On moving the upper part of the rectangle from north to south, the marked pole of the needle went north; when the wire was moved in the opposite direction, the marked pole went south. The same effect took place when the motion of the wire was in any other azimuth of the line of dip; the direction of the current always being conformable to the law formerly expressed (114.), and also to the directions obtained with the rotating ball (164.).

174. In these experiments it is not necessary to move the galvanometer or needle from its first position. It is quite sufficient if the wire of the rectangle is distorted where it leaves the instrument, and bent so as to allow the moving upper part to travel in the desired direction.

175. The moveable part of the wire was then arranged *below* the galvanometer, but so as to be carried across the dip. It affected the instrument as before, and in the same direction; *i. e.* when carried from west to east under the instrument, the marked end of the needle went west, as before. This should, of course be the case; for when the wire is cutting the magnetic dip in a certain direction, an electric current also in a certain direction should be induced in it.

176. If in fig. 31. dp be parallel to the dip, and BA be considered as the upper part of the rectangle (171.), with an arrow c attached to it, both these being retained in a plane perpendicular to the dip,—then, however BA with its attached arrow is moved upon dp as an axis, if it afterwards proceed

in the direction of the arrow, a current of electricity will move along it from B towards A.

177. When the moving part of the wire was carried up or down parallel to the dip, no effect was produced on the galvanometer. When the direction of motion was a little inclined to the dip, electricity manifested itself; and was at a maximum when the motion was perpendicular to the magnetic direction.

178. When the wire was bent into other forms and moved, equally strong effects were obtained, especially when instead of a rectangle a double catenarian curve was formed of it on one side of the galvanometer, and the two single curves or halves were swung in opposite directions at the same time; their action then combined to affect the galvanometer: but all the results were reducible to those above described.

179. The longer the extent of the moving wire, and the greater the space through which it moves, the greater is the effect upon the galvanometer.

180. The facility with which electric currents are produced in metals when moving under the influence of magnets, suggests that henceforth precautions should always be taken, in experiments upon metals and magnets, to guard against such effects. Considering the universality of the magnetic influence of the earth, it is a consequence which appears very extraordinary to the mind, that scarcely any piece of metal can be moved in contact with others, either at rest, or in motion with different velocities or in varying directions, without an electric current existing within them. It is probable that amongst arrangements of steam-engines and metal machinery, some curious accidental magneto-electric combinations may be found, producing effects which have never been observed, or, if noticed, have never as yet been understood.

181. Upon considering the effects of terrestrial magneto-electric induction which have now been described, it is almost impossible to resist the impression that similar effects, but infinitely greater in force, may be produced by the action of the globe, as a magnet, upon its own mass, in consequence of its diurnal rotation. It would seem that if a bar of metal be laid in these latitudes on the surface of the earth parallel to the mag-

netic meridian, a current of electricity tends to pass through it from south to north, in consequence of the travelling of the bar from west to east (172.), by the rotation of the earth; that if another bar in the same direction be connected with the first by wires, it cannot discharge the current of the first, because it has an equal tendency to have a current in the same direction induced within itself: but that if the latter be carried from east to west, which is equivalent to a diminution of the motion communicated to it from the earth (172.), then the electric current from south to north is rendered evident in the first bar, in consequence of its discharge, at the same time, by means of the second.

182. Upon the supposition that the rotation of the earth tended, by magneto-electro induction, to cause currents in its own mass, these would, according to the law (114.) and the experiments, be, upon the surface at least, from the parts in the neighbourhood of or towards the plane of the equator, in opposite directions to the poles; and if collectors could be applied at the equator and at the poles of the globe, as has been done with the revolving copper plate (150.), and also with magnets (220.), then negative electricity would be collected at the equator, and positive electricity at both poles (222.). But without the conductors, or something equivalent to them, it is evident these currents could not exist, as they could not be discharged.

183. I did not think it impossible that some natural difference might occur between bodies, relative to the intensity of the current produced or tending to be produced in them by magneto-electric induction, which might be shown by opposing them to each other; especially as Messrs. Arago, Babbage, Herschel, and Harris, have all found great differences, not only between the metals and other substances, but between the metals themselves, in their power of receiving motion from or giving it to a magnet in trials by revolution (130.). I therefore took two wires, each one hundred and twenty feet long, one of iron and the other of copper. These were connected with each other at their ends, and then extended in the direction of the magnetic meridian, so as to form two nearly parallel lines, nowhere in contact except at the extremities. The copper wire was then divided in the middle, and examined

by a delicate galvanometer, but no evidence of an electrical current was obtained.

184. By favour of His Royal Highness the President of the Society, I obtained the permission of His Majesty to make experiments at the lake in the gardens of Kensington-palace, for the purpose of comparing, in a similar manner, water and metal. The basin of this lake is artificial; the water is supplied by the Chelsea Company; no springs run into it, and it presented what I required, namely, a uniform mass of still pure water, with banks ranging nearly from east to west, and from north to south.

185. Two perfectly clean bright copper plates, each exposing four square feet of surface, were soldered to the extremities of a copper wire; the plates were immersed in the water, north and south of each other, the wire which connected them being arranged upon the grass of the bank. The plates were about four hundred and eighty feet from each other, in a right line; the wire was probably six hundred feet long. This wire was then divided in the middle, and connected by two cups of mercury with a delicate galvanometer.

186. At first, indications of electric currents were obtained; but when these were tested by inverting the direction of contact, and in other ways, they were found to be due to other causes than the one sought for. A little difference in temperature; a minute portion of the nitrate of mercury used to amalgamate the wires, entering into the water employed to reduce the two cups of mercury to the same temperature; was sufficient to produce currents of electricity, which affected the galvanometer, notwithstanding they had to pass through nearly five hundred feet of water. When these and other interfering causes were guarded against, no effect was obtained; and it appeared that even such dissimilar substances as water and copper, when cutting the magnetic curves of the earth with equal velocity, perfectly neutralized each other's action.

187. Mr. Fox of Falmouth has obtained some highly important results respecting the electricity of metalliferous veins in the mines of Cornwall, which have been published in the Philosophical Transactions*. I have examined the paper with a view to ascertain whether any of the effects were pro-

* 1830, p. 399.

bably referable to magneto-electric induction ; but, though unable to form a very strong opinion, believe they are not. When parallel veins running east and west were compared, the general tendency of the electricity *in the wires* was from north to south ; when the comparison was made between parts towards the surface and at some depth, the current of electricity in the wires was from above downwards. If there should be any natural difference in the force of the electric currents produced by magneto-electric induction in different substances, or substances in different positions moving with the earth, and which might be rendered evident by increasing the masses acted upon, then the wires and veins experimented with by Mr. Fox might perhaps have acted as dischargers to the electricity of the mass of strata included between them, and the directions of the currents would agree with those observed as above.

188. Although the electricity obtained by magneto-electric induction in a few feet of wire is of but small intensity, and has not yet been observed except in metals, and carbon in a particular state, still it has power to pass through brine (23.) ; and, as increased length in the substance acted upon produces increase of intensity, I hoped to obtain effects from extensive moving masses of water, though quiescent water gave none. I made experiments therefore (by favour) at Waterloo Bridge, extending a copper wire nine hundred and sixty feet in length upon the parapet of the bridge, and dropping from its extremities other wires with extensive plates of metal attached to them to complete contact with the water. Thus the wire and the water made one conducting circuit ; and as the water ebbed or flowed with the tide, I hoped to obtain currents analogous to those of the brass ball (161.).

189. I constantly obtained deflections at the galvanometer, but they were very irregular, and were, in succession, referred to other causes than that sought for. The different condition of the water as to purity on the two sides of the river ; the difference in temperature ; slight differences in the plates, in the solder used, in the more or less perfect contact made by twisting or otherwise ; all produced effects in turn : and though I experimented on the water passing through the middle arches only ; used platina plates instead of copper ; and took every other precaution, I could not after three days obtain any satisfactory results.

190. Theoretically, it seems a necessary consequence, that where water is flowing, there electric currents should be formed: thus, if a line be imagined passing from Dover to Calais through the sea, and returning through the land beneath the water to Dover, it traces out a circuit of conducting matter, one part of which, when the water moves up or down the channel, is cutting the magnetic curves of the earth, whilst the other is relatively at rest. This is a repetition of the wire experiment (171.), but with worse conductors. Still there is every reason to believe that electric currents do run in the general direction of the circuit described, either one way or the other, according as the passage of the water is up or down the channel. Where the lateral extent of the moving water is enormously increased, it does not seem improbable that the effect should become sensible; and the gulf stream may thus, perhaps, from electric currents moving across it, by magneto-electric induction from the earth, exert a sensible influence upon the forms of the lines of magnetic variation*.

191. Though positive results have not yet been obtained by the action of the earth upon water and aqueous fluids, yet, as the experiments are very limited in their extent, and as such fluids do yield the current by artificial magnets (23.), (for transference of the current is proof that it may be produced (213.)) the supposition made that the earth produces these induced currents within itself (181.) in consequence of its diurnal rotation, is still highly probable (222. 223.); and when it is considered that the moving masses extend for thousands of miles across the magnetic curves, cutting them in various directions within its mass, as well as at the surface, it is possible the electricity may rise to considerable intensity.

192. I hardly dare venture, even in the most hypothetical form, to ask whether the Aurora Borealis and Australis may not be the discharge of electricity, thus urged towards the poles of the earth, from whence it is endeavouring to return by natural and appointed means above the earth to the equatorial regions. The non-occurrence of it in very high latitudes

* Theoretically, even a ship or a boat when passing on the surface of the water, in northern or southern latitudes, should have currents of electricity running through it directly across the line of her motion; or if the water is flowing past the ship at anchor, similar currents should occur.

is not at all against the supposition ; and it is remarkable that Mr. Fox, who observed the deflections of the magnetic needle at Falmouth, by the Aurora Borealis, gives that direction of it which perfectly agrees with the present view. He states that all the variations at night were towards the east*, and this is what would happen if electric currents were setting from south to north in the earth under the needle, or from north to south in space above it.

§ 6. *General remarks and illustrations of the Force and Direction of Magneto-electric induction.*

193. In the repetition and variation of Arago's experiment by Messrs. Babbage, Herschel, and Harris, these philosophers directed their attention to the differences of force observed amongst the metals and other substances in their action on the magnet. These differences were very great†, and led me to hope that by mechanical combinations of various metals important results might be obtained (183). The following experiments were therefore made, with a view to obtain, if possible, any such difference of the action of two metals.

194. A piece of soft iron bonnet-wire covered with cotton was laid bare and cleaned at one extremity, and there fastened by metallic contact with the clean end of a copper wire. Both wires were then twisted together like the strands of a rope, for eighteen or twenty inches ; and the remaining parts being made to diverge, their extremities were connected with the wires of the galvanometer. The iron wire was about two feet long, the continuation to the galvanometer being copper.

195. The twisted copper and iron (touching each other nowhere but at the extremity) were then passed between the poles of a powerful magnet arranged horse-shoe fashion (fig. 32.) ; but not the slightest effect was observed at the galvanometer, although the arrangement seemed fitted to show any electrical difference between the two metals relative to the action of the magnet.

196. A soft iron cylinder was then covered with paper at the middle part, and the twisted portion of the above compound wire coiled as a spiral around it, the connexion with the galva-

* Philosophical Transactions, 1831, p. 202. † Ibid. 1825, p. 472 ; 1831, p. 78.

nometer still being made at the ends A B. The iron cylinder was then brought in contact with the poles of a powerful magnet capable of raising thirty pounds; yet no signs of electricity appeared at the galvanometer. Every precaution was applied in making and breaking contact to accumulate effect, but no indications of a current could be obtained.

197. Copper and tin, copper and zinc, tin and zinc, tin and iron, and zinc and iron, were tried against each other in a similar manner (194), but not the slightest sign of electric currents could be procured.

198. Two flat spirals, one of copper and the other of iron, containing each eighteen inches of wire were connected with each other and with the galvanometer, and then put face to face so as to be in contrary directions. When brought up to the magnetic pole (53.), no electrical indications at the galvanometer were observed. When one was turned round so that both were in the same direction, the effect at the galvanometer was very powerful.

199. The compound helix of copper and iron wire formerly described (8.) was arranged as a double helix, one of the helices being all iron and containing two hundred and fourteen feet, the other all copper and containing two hundred and eight feet. The two similar ends A A of the copper and iron helix were connected together, and the other ends B B of each helix connected with the galvanometer; so that when a magnet was introduced into the centre of the arrangement, the induced currents in the iron and copper would tend to proceed in contrary directions. Yet when a magnet was inserted, or a soft iron bar within made a magnet by contact with poles, no effect at the needle was produced.

200. A glass tube about fourteen inches long was filled with strong sulphuric acid. Twelve inches of the end of a clean copper wire were bent up into a bundle and inserted into the tube, so as to make good superficial contact with the acid, and the rest of the wire passed along the outside of the tube and away to the galvanometer. A wire similarly bent up at the extremity was immersed in the other end of the sulphuric acid, and also connected with the galvanometer, so that the acid and copper wire were in the same parallel relation to each other in this experiment as iron and copper were in the first (194).

When this arrangement was passed in a similar manner between the poles of the magnet, not the slightest effect at the galvanometer could be perceived.

201. From these experiments it would appear, that when metals of different kinds connected in one circuit are equally subject in every circumstance to magneto-electric induction, they exhibit exactly equal powers with respect to the currents which either are formed, or tend to form, in them. The same even appears to be the case with regard to fluids, and probably all other substances.

202. Still it seemed impossible that these results could indicate the relative inductive power of the magnet upon the different metals; for that the effect should be in some relation to the conducting power seemed a necessary consequence (139), and the influence of rotating plates upon magnets had been found to bear a general relation to the conducting power of the substance used.

203. In the experiments of rotation (81.), the electric current is excited and discharged in the same substance, be it a good or bad conductor; but in the experiments just described the current excited in iron could not be transmitted but through the copper, and that excited in copper had to pass through iron; *i. e.* supposing currents of dissimilar strength to be formed in the metals proportionate to their conducting power, the stronger current had to pass through the worst conductor, and the weaker current through the best.

204. Experiments were therefore made in which different metals insulated from each other were passed between the poles of the magnet, their opposite ends being connected with the same end of the galvanometer wire, so that the currents formed and led away to the galvanometer should oppose each other; and when considerable lengths of different wires were used, feeble deflections were obtained.

205. To obtain perfectly satisfactory results a new galvanometer was constructed, consisting of two independent coils, each containing eighteen feet of silked copper wire. These coils were exactly alike in shape and number of turns, and were fixed side by side with a small interval between them, in which a double needle could be hung by a fibre of silk exactly as in the former instrument (87.) The coils may be distinguished by

the letters K L, and when electrical currents were sent through them in the same direction, acted upon the needle with the sum of their powers; when in opposite directions, with the difference of their powers.

206. The compound helix (199. 8.) was now connected, the ends A and B of the iron with A and B ends of galvanometer coil K, and the ends A and B of the copper with B and A ends of galvanometer coil L, so that the currents excited in the two helices should pass in opposite directions through the coils K and L. On introducing a small cylinder magnet within the helices, the galvanometer needle was powerfully deflected. On disuniting the iron helix, the magnet caused with the copper helix alone still stronger deflection in the same direction. On reuniting the iron helix, and unconnecting the copper helix, the magnet caused a moderate deflection in the contrary direction. Thus it was evident that the electric current induced by a magnet in a copper wire was far more powerful than the current induced by the same magnet in an equal iron wire.

207. To prevent any error that might arise from the greater influence, from vicinity or other circumstances, of one coil on the needle beyond that of the other, the iron and copper terminations were changed relative to the galvanometer coils K L, so that the one which before carried the current from the copper now conveyed that from the iron, and vice versâ. But the same striking superiority of the copper was manifested as before. This precaution was taken in the rest of the experiments with other metals to be described.

208. I then had wires of iron, zinc, copper, tin, and lead, drawn to the same diameter (very nearly one twentieth of an inch), and I compared exactly equal lengths, namely sixteen feet, of each in pairs in the following manner: The ends of the copper wire were connected with the ends A and B of galvanometer coil K, and the ends of the zinc wire with the terminations A and B of the galvanometer coil L. The middle part of each wire was then coiled six times round a cylinder of soft iron covered with paper, long enough to connect the poles of Daniell's horse-shoe magnet (56,) (fig. 33.), so that similar helices of copper and zinc, each of six turns, surrounded the bar at two places equidistant from each other and from the poles of the magnet; but these helices were purposely arranged

so as to be in contrary directions, and therefore send contrary currents through the galvanometer coils K and L.

209. On making and breaking contact between the soft iron bar and the poles of the magnet, the galvanometer was strongly affected; on detaching the zinc it was still more strongly affected in the same direction. On taking all the precautions before alluded to (207.), with others, it was abundantly proved that the current induced by the magnet in copper was far more powerful than in zinc.

210. The copper was then compared in a similar manner with tin, lead, and iron, and surpassed them all, even more than it did zinc. The zinc was then compared experimentally with the tin, lead, and iron, and found to produce a more powerful current than any of them. Iron in the same manner proved superior to tin and lead. Tin came next, and lead the last.

211. Thus the order of these metals is copper, zinc, iron, tin, and lead. It is exactly their order with respect to conducting power for electricity, and, with the exception of iron, is the order presented by the magneto-rotation experiments of Messrs. Babbage, Herschel, Harris, &c. The iron has additional power in the latter kind of experiments, because of its ordinary magnetic relations, and its place relative to magneto-electric action of the kind now under investigation cannot be ascertained by such trials. In the manner above described it may be correctly ascertained.*

212. It must still be observed that in these experiments the whole effect between different metals is not obtained; for of the thirty-four feet of wire included in each circuit, eighteen feet are copper in both, being the wire of the galvanometer coils; and as the whole circuit is concerned in the resulting force of the current, this circumstance must tend to diminish the difference which would appear between the metals if the circuits were of the same substances throughout. In the present case the difference obtained is probably not more than

* Mr. Christie, who being appointed reporter upon this paper, had it in his hands before it was complete, felt the difficulty (202.); and to satisfy his mind, made experiments upon iron and copper with the large magnet (44.), and came to the same conclusions as I have arrived at. The two sets of experiments were perfectly independent of each other, neither of us being aware of the other's proceedings.

a half of that which would be given if the whole of each circuit were of one metal.

213. These results tend to prove that the currents produced by magneto-electric induction in bodies is proportional to their conducting power. That they are *exactly* proportional to and altogether dependent upon the conducting power, is, I think, proved by the perfect neutrality displayed when two metals or other substances, as acid, water, &c. &c. (201. 186.), are opposed to each other in their action. The feeble current which tends to be produced in the worse conductor, has its transmission favoured in the better conductor, and the stronger current which tends to form in the latter has its intensity diminished by the obstruction of the former; and the forces of generation and obstruction are so perfectly balanced as to neutralize each other exactly. Now as the obstruction is inversely as the conducting power, the tendency to generate a current must be directly as that power to produce this perfect equilibrium.

214. The cause of the equality of action under the various circumstances described, where great extent of wire (183.) or wire and water (184.) were connected together, which yet produced such different effects upon the magnet, is now evident and simple.

215. The effects of a rotating substance upon a needle or magnet ought, where ordinary magnetism has no influence, to be directly as the conducting power of the substance; and I venture now to predict that such will be found to be the case; and that in all those instances where non-conductors have been supposed to exhibit this peculiar influence, the motion has been due to some interfering cause of an ordinary kind; as mechanical communication of motion through the parts of the apparatus, or otherwise (as in the case Mr. Harris has pointed out*); or else to ordinary magnetic attractions. To distinguish the effects of the latter from those of the induced electric currents, I have been able to devise a most perfect test, which shall be almost immediately described (243.).

216. There is every reason to believe that the magnet or magnetic needle will become an excellent measurer of the conducting power of substances rotated near it; for I have found

* Philosophical Transactions, 1831, p. 68.

by careful experiment, that when a constant current of electricity was sent successively through a series of wires of copper, platina, zinc, silver, lead, and tin, drawn to the same diameter; the deflection of the needle was exactly equal by them all. It must be remembered that when bodies are rotated in a horizontal plane, the magnetism of the earth is active upon them. As the effect is general to the whole of the plate, it may not interfere in these cases; but in some experiments and calculations may be of important consequence.

217. Another point which I endeavoured to ascertain, was, whether it was essential or not that the moving part of the wire should, in cutting the magnetic curves, pass into positions of greater or lesser magnetic force; or whether, always intersecting curves of equal magnetic intensity, the mere motion was sufficient for the production of the current. That the latter is true, has been proved already in several of the experiments on terrestrial magneto-electric induction. Thus the electricity evolved from the copper plate (149.), the currents produced in the rotating globe (161, &c.), and those passing through the moving wire (171.), are all produced under circumstances in which the magnetic force could not but be the same during the whole experiments.

218. To prove the point with an ordinary magnet, a copper disc was cemented upon the end of a cylinder magnet, with paper intervening; the magnet and disc were rotated together, and collectors (attached to the galvanometer) brought in contact with the circumference and the central part of the copper plate. The galvanometer needle moved as in former cases, and the *direction* of motion was the *same* as that which would have resulted, if the copper only had revolved, and the magnet been fixed. Neither was there any apparent difference in the quantity of deflection. Hence, rotating the magnet causes no difference in the results; for a rotatory and a stationary magnet produce the same effect upon the moving copper.

219. A copper cylinder, closed at one extremity, was then put over the magnet, one half of which it enclosed like a cap; it was firmly fixed, and prevented from touching the magnet anywhere by interposed paper. The arrangement was then floated in a narrow jar of mercury, so that the lower edge of the

copper cylinder touched the fluid metal ; one wire of the galvanometer dipped into this mercury, and the other into a little cavity in the centre of the end of the copper cap. Upon rotating the magnet and its attached cylinder, abundance of electricity passed through the galvanometer, and in the same direction as if the cylinder had rotated only, the magnet being still. The results therefore were the same as those with the disc (218.).

220. That the metal of the magnet itself might be substituted for the moving cylinder, disc, or wire, seemed an inevitable consequence, and yet one which would exhibit the effects of magneto-electric induction in a striking form. A cylinder magnet had therefore a little hole made in the centre of each end to receive a drop of mercury, and was then floated pole upwards in the same metal contained in a narrow jar. One wire from the galvanometer dipped into the mercury of the jar, and the other into the drop contained in the hole at the upper extremity of the axis. The magnet was then revolved by a piece of string passed round it, and the galvanometer-needle immediately indicated a powerful current of electricity. On reversing the order of rotation, the electrical current was reversed. The direction of the electricity was the same as if the copper cylinder (219.) or a copper wire had revolved round the fixed magnet in the same direction as that which the magnet itself had followed. Thus a *singular independence* of the magnetism and the bar in which it resides is rendered evident.

221. In the above experiment the mercury reached about half way up the magnet ; but when its quantity was increased until within one eighth of an inch of the top, or diminished until equally near the bottom, still the same effects and the *same direction* of electrical current was obtained. But in those extreme proportions the effects did not appear so strong as when the surface of the mercury was about the middle, or between that and an inch from each end. The magnet was eight inches and a half long, and three quarters of an inch in diameter.

222. Upon inversion of the magnet, and causing rotation in the same direction, *i. e.* always screw or always unscrew, then a contrary current of electricity was produced. But when the motion of the magnet was continued in a direction constant

in relation to its *own axis*, then electricity of the same kind was collected at both poles, and the opposite electricity at the equator, or in its neighbourhood, or in the parts corresponding to it. If the magnet be held parallel to the axis of the earth, with its unmarked pole directed to the pole star, and then rotated so that the parts at its southern side pass from west to east in conformity to the motion of the earth; then positive electricity may be collected at the extremities of the magnet, and negative electricity at or about the middle of its mass.

223. When the galvanometer was very sensible, the mere spinning of the magnet in the air, whilst one of the galvanometer wires touched the extremity, and the other the equatorial parts, was sufficient to evolve a current of electricity and deflect the needle.

224. Experiments were then made with a similar magnet, for the purpose of ascertaining whether any return of the electric current could occur at the central or axial parts, they having the same angular velocity of rotation as the other parts (259.); the belief being that it could not.

225. A cylinder magnet, seven inches in length, and three quarters of an inch in diameter, had a hole pierced in the direction of its axis from one extremity, a quarter of an inch in diameter, and three inches deep. A copper cylinder, surrounded by paper and amalgamated at both extremities, was introduced so as to be in metallic contact at the bottom of the hole, by a little mercury, with the middle of the magnet; insulated at the sides by the paper; and projecting about a quarter of an inch above the end of the steel. A quill was put over the copper rod, which reached to the paper, and formed a cup to receive mercury for the completion of the circuit. A high paper edge was also raised round that end of the magnet and mercury put within it, which however had no metallic connexion with that in the quill, except through the magnet itself and the copper rod (fig. 34.). The wires A and B from the galvanometer were dipped into these two portions of mercury; any current through them could, therefore, only pass down the magnet towards its equatorial parts, and then up the copper rod; or vice versâ.

226. When thus arranged and rotated screw fashion, the marked end of the galvanometer needle went west, indicating

that there was a current through the instrument from A to B, and consequently from B through the magnet and copper rod to A (fig. 34.).

227. The magnet was then put into a jar of mercury (fig. 35.) as before (219.); the wire A left in contact with the copper axis, but the wire B dipped in the mercury of the jar, and therefore in metallic communication with the equatorial parts of the magnet instead of its polar extremity. On revolving the magnet screw fashion, the galvanometer needle was deflected in the same direction as before, but far more powerfully. Yet it is evident that the parts of the magnet from the equator to the pole were out of the electric circuit.

228. Then the wire A was connected with the mercury on the extremity of the magnet, the wire B still remaining in contact with that in the jar (fig. 36.), so that the copper axis was altogether out of the circuit. The magnet was again revolved screw fashion, and again caused the same deflection of the needle, the current being as strong as it was in the last trial (227.), and much stronger than at first (226.).

229. Hence it is evident that there is no discharge of the current at the centre of the magnet, for the current, now freely evolved, is up through the magnet; but in the first experiment (226.), it was down. In fact, at that time, it was only the part of the moving metal equal to a little disc extending from the end of the wire B in the mercury to the wire A that was efficient, *i. e.* moving with a different angular velocity to the rest of the circuit (258.); and for that portion the direction of the current is consistent with the other results.

230. In the two after experiments, the *lateral* parts of the magnet or of the copper rod are those which move relative to the other parts of the circuit, *i. e.* the galvanometer wires; and being more extensive, intersecting more curves, or moving with more velocity, produce the greater effect. For the discal part, the direction of the induced electric current is the same in all, namely, from the circumference towards the centre.

231. The law under which the induced electric current excited in bodies moving relatively to magnets, is made dependent on the intersection of the magnetic curves by the metal (114.) being thus rendered more precise and definite (217. 220. 224.),

seem now even to apply to the cause in the first section of the former paper (26.) ; and by rendering a perfect reason for the effects produced, take away any for supposing that peculiar condition, which I ventured to call the electro-tonic state (60.).

232. When an electrical current is passed through a wire, that wire is surrounded at every part by magnetic curves, diminishing in intensity according to their distance from the wire, and which in idea may be likened to rings situated in planes perpendicular to the wire or rather to the electric current within it. These curves, although different in form, are perfectly analogous to those existing between two contrary magnetic poles opposed to each other; and when a second wire, parallel to that which carries the current, is made to approach the latter (18.), it passes through magnetic curves exactly of the same kind as those it would intersect when carried between opposite magnetic poles (109.) in one direction; and as it recedes from the inducing wire, it cuts the curves around it in the same manner that it would do those between the same poles if moved in the other direction.

233. If the wire *N P* (fig. 40.) have an electric current passed through it in the direction from *P* to *N*, then the dotted ring may represent a magnetic curve round it, and it is in such a direction that if small magnetic needles be placed as tangents to it, they will become arranged as in the figure, *n* and *s* indicating north and south ends (44. note).

234. But if the current of electricity were made to cease for a while, and magnetic poles were used instead to give direction to the needles, and make them take the same position as when under the influence of the current, then they must be arranged as at fig. 41; the marked and unmarked poles *a b* above the wire, being in opposite directions to those *a' b'* below. In such a position therefore the magnetic curves between the poles *a b* and *a' b'* have the same general direction with the corresponding parts of the ring magnetic curve surrounding the wire *N P* carrying an electric current.

235. If the second wire *p n* (fig. 40.) be now brought towards the principal wire, carrying a current, it will cut an infinity of magnetic curves, similar in direction to that figured, and consequently similar in direction to those between the poles *a b* of the magnets (fig. 41.), and it will intersect

these current curves in the same manner as it would the magnet curves, if it passed from above between the poles downwards. Now, such an intersection would, with the magnets, induce an electric current in the wire from p to n (114.); and therefore as the curves are alike in arrangement, the same effect ought to result from the intersection of the magnetic curves dependent on the current in the wire NP ; and such is the case, for on approximation the induced current is in the opposite direction to the principal current (19.).

236. If the wire $p'n'$ be carried up from below, it will pass in the opposite direction between the magnetic poles; but then also the magnetic poles themselves are reversed (fig. 41.), and the induced current is therefore (114.) still in the same direction as before. It is also, for equally sufficient and evident reasons, in the same direction, if produced by the influence of the curves dependent upon the wire.

237. When the second wire is retained at rest in the vicinity of the principal wire, no current is induced through it, for it is intersecting no magnetic curves. When it is removed from the principal wire, it intersects the curves in the opposite direction to what it did before (235.); and a current in the opposite direction is induced, which therefore corresponds with the direction of the principal current (19.). The same effect would take place if by inverting the direction of motion of the wire in passing between either set of poles (fig. 41.), it were made to intersect the curves there existing in the opposite direction to what it did before.

238. In the first experiments (10. 13.), the inducing wire and that under induction were arranged at a fixed distance from each other, and then an electric current sent through the former. In such cases the magnetic curves themselves must be considered as moving (if I may use the expression) across the wire under induction, from the moment at which they begin to be developed until the magnetic force of the current is at its utmost; expanding as it were from the wire outwards, and consequently being in the same relation to the fixed wire under induction, as if *it* had moved in the opposite direction across them, or towards the wire carrying the current. Hence the first current induced in such cases was in the contrary direction to the principal current (17. 235.). On breaking the battery con-

taet, the magnetic curves (which are mere expressions for arranged magnetic forces) may be conceived as contracting upon and returning towards the failing electrical current, and therefore move in the opposite direction across the wire, and cause an opposite induced current to the first.

239. When, in experiments with ordinary magnets, the latter, in place of being moved past the wires, were actually made near them (27. 36.), then a similar progressive development of the magnetic curves may be considered as having taken place, producing the effects which would have occurred by motion of the wires in one direction; the destruction of the magnetic power corresponds to the motion of the wire in the opposite direction.

240. If, instead of intersecting the magnetic curves of a straight wire carrying a current, by approximating or removing a second wire (235.), a revolving plate be used, being placed for that purpose near the wire, and, as it were, amongst the magnetic curves, then it ought to have continuous electric currents induced within it; and if a line joining the wire with the centre of the plate were perpendicular to both, then the induced current ought to be, according to the law (114.), directly across the plate, from one side to the other, and at right angles to the direction of the inducing current.

241. A single metallic wire one twentieth of an inch in diameter had an electric current passed through it, and a small copper disc one inch and a half in diameter revolved near to and under, but not in actual contact with it (fig. 39.). Collectors were then applied at the opposite edges of the disc, and wires from them connected with the galvanometer. As the disc revolved in one direction, the needle was deflected on one side; and when the direction of revolution was reversed, the needle was inclined on the other side, in accordance with the results anticipated.

242. Thus the reasons which induce me to suppose a particular state in the wire (60.) have disappeared; and though it still seems to me unlikely that a wire at rest in the neighbourhood of another carrying a powerful electric current is entirely indifferent to it, yet I am not aware of any distinct *facts* which authorize the conclusion that it is in a particular state.

243. In considering the nature of the cause assigned in these

papers to account for the mutual influence of magnets and moving metals (120.), and comparing it with that heretofore admitted, namely, the induction of a feeble magnetism like that produced in iron, it occurred to me that a most decisive experimental test of the two views could be applied (215.).

244. No other known power has like direction with that exerted between an electric current and a magnetic pole; it is tangential, while all other forces, acting at a distance, are direct. Hence, if a magnetic pole on one side of a revolving plate follow its course by reason of its obedience to the tangential force exerted upon it by the very current of electricity which it has itself caused, a similar pole on the opposite side of the plate should immediately set it free from this force; for the currents which tend to be formed by the action of the two poles are in opposite directions; or rather no current tends to be formed, or no magnetic curves are intersected (114.); and therefore the magnet should remain at rest. On the contrary, if the action of a north magnetic pole were to produce a southness in the nearest part of the copper plate, and a diffuse northness elsewhere (82.), as is really the case with iron; then the use of another north pole on the opposite side of the same part of the plate should double the effect instead of destroying it, and double the tendency of the first magnet to move with the plate.

245. A thick copper plate (85.) was therefore fixed on a vertical axis, a bar magnet was suspended by a plaited silk cord, so that its marked pole hung over the edge of the plate, and a sheet of paper being interposed, the plate was revolved; immediately the magnetic pole obeyed its motion and passed off in the same direction. A second magnet of equal size and strength was then attached to the first, so that its marked pole should hang *beneath* the edge of the copper plate in a corresponding position to that above, and at an equal distance (fig. 37.). Then a paper sheath or screen being interposed as before, and the plate revolved, the poles were found entirely indifferent to its motion, although either of them alone would have followed the course of rotation.

246. On turning one magnet round, so that *opposite* poles were on each side of the plate, then the mutual action of the poles and the moving metal was a maximum.

247. On suspending one magnet so that its axis was level

with the plate, and either pole opposite its edge, the revolution of the plate caused no motion of the magnet. The electrical currents dependent upon induction would now tend to be produced in a vertical direction across the thickness of the plate, but could not be so discharged, or at least only to so slight a degree as to leave all effects insensible; but ordinary magnetic induction, or that on an iron plate, would be equally if not more powerfully developed in such a position (251.).

248. Then, with regard to the production of electricity in these cases:—whenever motion was communicated by the plate to the magnets, currents existed; when it was not communicated, they ceased. A marked pole of a large bar magnet was put under the edge of the plate; collectors (86.) applied at the axis and edge of the plate as on former occasions (fig. 38.), and these connected with the galvanometer; when the plate was revolved, abundance of electricity passed to the instrument. The unmarked pole of a similar magnet was then put over the place of the former pole, so that contrary poles were above and below; on revolving the plate, the electricity was more powerful than before. The latter magnet was then turned end for end, so that marked poles were both above and below the plate, and then, upon revolving it, scarcely any electricity was procured. By adjusting the distance of the poles so as to correspond with their relative force, they at last were brought so perfectly to neutralize each other's inductive action upon the plate, that no electricity could be obtained with the most rapid motion.

249. I now proceeded to compare the effect of similar and dissimilar poles upon iron and copper, adopting for the purpose Mr. Sturgeon's very useful form of Arago's experiment. This consists in a circular plate of metal supported in a vertical plane by a horizontal axis, and weighted a little at one edge or rendered excentric so as to vibrate like a pendulum. The poles of the magnets are applied near the side and edges of these plates, and then the number of vibrations, required to reduce the vibrating are a certain constant quantity, noted. In the first description of this instrument* it is said that opposite poles produced the greatest retarding effect, and similar poles none; and yet within a page of the place the

* Edin. Phil. Journal, 1825, p. 124.

effect is considered as of the same kind with that produced in iron.

250. I had two such plates mounted, one of copper, one of iron. The copper plate alone gave sixty vibrations, in the average of several experiments, before the arc of vibration was reduced from one constant mark to another. On placing opposite magnetic poles near to, and on each side of, the same place, the vibrations were reduced to fifteen. On putting similar poles on each side of it, they rose to fifty; and on placing two pieces of wood of equal size with the poles equally near, they became fifty-two. So that, when similar poles were used, the magnetic effect was little or none (the obstruction being due to the confinement of the air, rather), whilst with opposite poles it was the greatest possible. When a pole was presented to the edge of the plate, no retardation occurred.

251. The iron plate alone made thirty-two vibrations, whilst the arc of vibration diminished a certain quantity. On presenting a magnetic pole to the edge of the plate (247.), the vibrations were diminished to eleven; and when the pole was about half an inch from the edge, to five.

252. When the marked pole was put at the side of the iron plate at a certain distance, the number of vibrations was only five. When the marked pole of the second bar was put on the opposite side of the plate at the same distance (250.), the vibrations were reduced to two. But when the second pole was an unmarked one, yet occupying exactly the same position, the vibrations rose to twenty-two. By removing the stronger of these two opposite poles a little way from the plate, the vibrations increased to thirty-one, or nearly the original number. But on removing it *altogether*, they fell to between five and six.

253. Nothing can be more clear, therefore, than that with iron, and bodies admitting of ordinary magnetic induction, *opposite* poles on opposite sides of the edge of the plate neutralize each other's effect, whilst *similar* poles exalt the action; a single pole end on is also sufficient. But with copper, and substances not sensible to ordinary magnetic impressions, *similar* poles on opposite sides of the plate neutralize each other; *opposite* poles exalt the action; and a single pole at the edge or end on does nothing.

254. Nothing can more completely show the thorough independence of the effects obtained with the metals by Arago, and those due to ordinary magnetic forces ; and henceforth, therefore, the application of two poles to various moving substances will, if they appear at all magnetically affected, afford a proof of the nature of that affection. If opposite poles produce a greater effect than one pole, the result will be due to electric currents. If similar poles produce more effect than one, then the power is *not* electrical ; it is not like that active in the metals and carbon when they are moving, and in most cases will probably be found to be not even magnetical, but the result of irregular causes not anticipated and consequently not guarded against.

255. The result of these investigations tends to show that there are really but very few bodies that are magnetic in the manner of iron. I have often sought for indications of this power in the common metals and other substances ; and once in illustration of Arago's objection (82.), and in hopes of ascertaining the existence of currents in metals by the momentary approach of a magnet, suspended a disc of copper by a single fibre of silk in an excellent vacuum, and approximated powerful magnets on the outside of the jar, making them approach and recede in unison with a pendulum that vibrated as the disc would do : but no motion could be obtained ; not merely, no indication of ordinary magnetic powers, but none of *any electric current* occasioned in the metal by the approximation and recession of the magnet. I therefore venture to arrange substances in three classes as regards their relation to magnets ; first, those which are affected when at rest, like iron, nickel, &c., being such as possess ordinary magnetic properties ; then, those which are affected when in motion, being conductors of electricity in which are produced electric currents by the inductive force of the magnet ; and, lastly, those which are perfectly indifferent to the magnet, whether at rest or in motion.

256. Although it will require further research, and probably elose investigation, both experimental and mathematical, before the exact mode of action between a magnet and metal moving relatively to each other is ascertained ; yet many of the results appear sufficiently clear and simple to allow of expression in a

somewhat general manner.—If a terminated wire move so as to cut a magnetic curve, a power is called into action which tends to urge an electric current through it; but this current cannot be brought into existence unless provision be made at the ends of the wire for its discharge and renewal.

257. If a second wire move in the same direction as the first, the same power is exerted upon it, and it is therefore unable to alter the condition of the first: for there appear to be no natural differences among substances when connected in a series, by which, when moving under the same circumstances relative to the magnet, one tends to produce a more powerful electric current in the whole circuit than another (201. 214.).

258. But if the second wire move with a different velocity, or in some other direction, then variations in the force exerted take place; and if connected at their extremities, an electric current passes through them.

259. Taking, then, a mass of metal or an endless wire, and referring to the pole of the magnet as a centre of action, (which though perhaps not strictly correct may be allowed for facility of expression, at present,) if all parts move in the same direction, and with the same angular velocity, and through magnetic curves of constant intensity, then no electric currents are produced. This point is easily observed with masses subject to the earth's magnetism, and may be proved with regard to small magnets; by rotating them, and leaving the metallic arrangements stationary, no current is produced.

260. If one part of the wire or metal cut the magnetic curves, whilst the other is stationary, then currents are produced. All the results obtained with the galvanometer are more or less of this nature, the galvanometer extremity being the fixed part. Even those with the wire, galvanometer, and earth (170.), may be considered so without any error in the result.

261. If the motion of the metal be in the same direction, but the angular velocity of its parts relative to the pole of the magnet different, then currents are produced. This is the case in Arago's experiment, and also in the wire subject to the earth's induction (172.), when it was moved from west to east.

262. If the magnet moves not directly to or from the arrangement, but laterally, then the case is similar to the last.

263. If different parts move in opposite directions across

the magnetic curves, then the effect is a maximum for equal velocities.

264. All these in fact are variations of one simple condition, namely, that all parts of the mass shall not move in the same direction across the curves, and with the same angular velocity. But they are forms of expression which, being retained in the mind, I have found useful when comparing the consistency of particular phenomena with general results.

Royal Institution,

December 21, 1831.

THIRD SERIES.

§ 7. *Identity of Electricities derived from different sources.*

§ 8. *Relation by measure of common and voltaic Electricity.*

[Read January 10th and 17th, 1833.]

§ 7. *Identity of Electricities derived from different sources.*

265. THE progress of the electrical researches which I have had the honour to present to the Royal Society, brought me to a point at which it was essential for the further prosecution of my inquiries that no doubt should remain of the identity or distinction of electricities excited by different means. It is perfectly true that Cavendish*, Wollaston†, Colladon‡, and others, have in succession removed some of the greatest objections to the acknowledgement of the identity of common, animal, and voltaic electricity, and I believe that most philosophers consider these electricities as really the same. But on the other hand it is also true, that the accuracy of Wollaston's experiments have been denied§; and also that one of them, which really is no proper proof of chemical decomposition by common electricity (309. 327.), has been that selected by several experimenters as the test of chemical action (336. 346.). It is a fact, too, than many philosophers are still drawing distinctions between the electricities of different sources; or at least doubting whether their identity is proved. Sir Humphry Davy, for instance, in his paper on the Torpedo||, thought it

* Phil. Trans. 1776, p. 196.

† Ibid. 1801, p. 434.

‡ Annales de Chimie, 1826, p. 62, &c. § Phil. Trans. 1832, p. 282, note.

|| Phil. Trans. 1829, p. 17. "Common electricity is excited upon non-conductors, and is readily carried off by conductors and imperfect conductors. Voltaic electricity is excited upon combinations of perfect and imperfect conductors, and is only transmitted by perfect conductors or imperfect conductors of the best kind. Magnetism, if it be a form of electricity, belongs only to perfect conductors; and, in its modifications, to a peculiar class of them¹. Animal electricity resides only in the imperfect conductors forming the organs of living animals, &c."

¹ Dr. Ritchie has shown this is not the case, Phil. Trans. 1832, p. 294.

probable that animal electricity would be found of a peculiar kind; and referring to it, to common electricity, voltaic electricity and magnetism, has said, "Distinctions might be established in pursuing the various modifications or properties of electricity in these different forms, &c." Indeed I need only refer to the last volume of the Philosophical Transactions to show that the question is by no means considered as settled*.

266. Notwithstanding, therefore, the general impression of the identity of electricities, it is evident that the proofs have not been sufficiently clear and distinct to obtain the assent of all those who were competent to consider the subject; and the question seemed to me very much in the condition of that which Sir H. Davy solved so beautifully,—namely, whether voltaic electricity in all cases merely eliminated, or did not in some actually produce, the acid and alkali found after its action upon water. The same necessity that urged him to decide the doubtful point, which interfered with the extension of his views, and destroyed the strictness of his reasoning, has obliged me to ascertain the identity or difference of common and voltaic electricity. I have satisfied myself that they are identical, and I hope the experiments which I have to offer, and the proofs flowing from them, will be found worthy the attention of the Royal Society.

* Phil. Trans. 1832, p. 259. Dr. Davy, in making experiments on the torpedo, obtains effects the same as those produced by common and voltaic electricity, and says that in its magnetic and chemical power it does not seem to be essentially peculiar,—p. 274; but then he says, p. 275, there are other points of difference; and after referring to them, adds, "How are these differences to be explained? Do they admit of explanation similar to that advanced by Mr. Cavendish in his theory of the torpedo; or may we suppose, according to the analogy of the solar ray, that the electrical power, whether excited by the common machine, or by the voltaic battery, or by the torpedo, is not a simple power, but a combination of powers, which may occur variously associated, and produce all the varieties of electricity with which we are acquainted?"

At p. 279 of the same volume of Transactions is Dr. Ritchie's paper, from which the following are extracts: "Common electricity is diffused over the surface of the metal;—voltaic electricity exists within the metal. Free electricity is conducted over the surface of the thinnest gold leaf as effectually as over a mass of metal having the same surface;—voltaic electricity requires thickness of metal for its conduction," p. 280: and again, "The supposed analogy between common and voltaic electricity, which was so eagerly traced after the invention of the pile, completely fails in this case, which was thought to afford the most striking resemblance." p. 291.

267. The various phenomena exhibited by electricity may, for the purpose of comparison, be arranged under two heads; namely, those connected with electricity of tension, and those belonging to electricity in motion. This distinction is taken at present not as philosophical, but merely as convenient. The effect of electricity of tension, at rest, is either attraction or repulsion at sensible distances. The effects of electricity in motion or electrical currents may be considered as 1st, Evolution of heat; 2nd, Magnetism; 3rd, Chemical decomposition; 4th, Physiological phenomena; 5th, Spark. It will be my object to compare electricities from different sources, and especially common and voltaic electricities, by their power of producing these effects.

I. *Voltaic Electricity.*

268. *Tension.*—When a voltaic battery of 100 pairs of plates has its extremities examined by the ordinary electrometer, it is well known that they are found positive and negative, the gold leaves at the same extremity repelling each other, the gold leaves at different extremities attracting each other, even when half an inch or more of air intervenes.

269. That ordinary electricity is discharged by points with facility through air; that it is readily transmitted through highly rarefied air; and also through heated air, as for instance a flame; is due to its high tension. I sought, therefore, for similar effects in the discharge of voltaic electricity, using as a test of the passage of the electricity either the galvanometer or chemical action produced by the arrangement hereafter to be described (312. 316.).

270. The voltaic battery I had at my disposal consisted of 140 pairs of plates four inches square, with double coppers. It was insulated throughout, and diverged a gold leaf electrometer about one third of an inch. On endeavouring to discharge this battery by delicate points very nicely arranged and approximated, either in the air or in an exhausted receiver, I could obtain no indications of a current, either by magnetic or chemical action. In this, however, was found no point of discordance between voltaic and common electricity; for when a Leyden battery (291.) was charged so as to deflect the gold leaf electrometer to the same degree, the points were found equally unable to discharge it with such effect as to produce either magnetic or chemical action. This was not because

common electricity could not produce both these effects (307. 310.), but because when of such low intensity the quantity required to make the effects visible (being enormously great (371. 375),) could not be transmitted in any reasonable time. In conjunction with the other proofs of identity hereafter to be given, these effects of points also prove identity instead of difference between voltaic and common electricity.

271. As heated air discharges common electricity with far greater facility than points, I hoped that voltaic electricity might in this way also be discharged. An apparatus was therefore constructed (Plate III. fig. 46.), in which A B is an insulated glass rod upon which two copper wires, C, D, are fixed firmly; to these wires are soldered two pieces of fine platina wire, the ends of which are brought very close to each other at *e*, but without touching; the copper wire C was connected with the positive pole of a voltaic battery, and the wire D with a decomposing apparatus (312. 316.), from which the communication was completed to the negative pole of the battery. In these experiments only two troughs, or twenty pairs of plates, were used.

272. Whilst in the state described, no decomposition took place at the point *a*, but when the side of a spirit-lamp flame was applied to the two platina extremities at *e*, so as to make them bright red-hot, decomposition occurred; iodine soon appeared at the point *a*, and the transference of electricity through the heated air was established. On raising the temperature of the points *e* by a blowpipe, the discharge was rendered still more free, and decomposition took place instantly. On removing the source of heat, the current immediately ceased. On putting the ends of the wires very close by the side of and parallel to each other, but not touching, the effects were perhaps more readily obtained than before. On using a larger voltaic battery (270.), they were also more freely obtained.

273. On removing the decomposing apparatus and interposing a galvanometer instead, heating the points *e* as the needle would swing one way, and removing the heat during the time of its return (302.), feeble deflections were soon obtained: thus also proving the current through heated air; but the instrument used was not so sensible under the circumstances as chemical action.

274. These effects, not hitherto known or expected under this form, are only cases of the discharge which takes place through air between the charcoal terminations of the poles of a powerful battery, when they are gradually separated after contact. Then the passage is through heated air exactly as with common electricity, and Sir H. Davy has recorded that with the original battery of the Royal Institution this discharge passed through a space of at least four inches*. In the exhausted receiver the electricity would *strike* through nearly half an inch of space, and the combined effects of rarefaction and heat was such upon the inclosed air as to enable it to conduct the electricity through a space of six or seven inches.

275. The instantaneous charge of a Leyden battery by the poles of a voltaic apparatus is another proof of the tension, and also the quantity of electricity evolved by the latter. Sir H. Davy says †, “When the two conductors from the ends of the combination were connected with a Leyden battery, one with the internal, the other with the external coating, the battery instantly became charged; and on removing the wires and making the proper connexions, either a shock or a *spark* could be perceived: and the least possible time of contact was sufficient to renew the charge to its full intensity.”

276. *In motion*; i. *Evolution of Heat*.—The evolution of heat in wires and fluids by the voltaic current is matter of general notoriety.

277. ii. *Magnetism*.—No fact is better known to philosophers than the power of the voltaic current to deflect the magnetic needle, and to make magnets according to *certain laws*; and no effect can be more distinctive of an electrical current.

278. iii. *Chemical decomposition*.—The chemical powers of the voltaic current, and their subjection to *certain laws*, are also perfectly well known.

279. iv. *Physiological effects*.—The power of the voltaic current, when strong, to shock and convulse the whole animal system, and when weak to affect the tongue and the eyes, is very characteristic.

280. v. *Spark*.—The brilliant star of light produced by the

* Elements of Chemical Philosophy, p. 153.

† Ibid. p. 154.

discharge of a voltaic battery is known to all as the most beautiful light that man can produce by art.

281. That these effects may be almost infinitely varied, some being exalted whilst others are diminished, is universally acknowledged; and yet without any doubt of the identity of character of the voltaic currents thus made to differ in their effect. The beautiful explication of these variations afforded by Cavendish's theory of quantity and intensity requires no support at present, as it is not supposed to be doubted.

282. In consequence of the comparisons that will hereafter arise between wires carrying voltaic and ordinary electricities, and also because of certain views of the condition of a wire or any other conducting substance connecting the poles of a voltaic apparatus, it will be necessary to give some definite expression of what is called the voltaic current, in contradistinction to any supposed peculiar state of arrangement, not progressive, which the wire or the electricity within it may be supposed to assume. If two voltaic troughs P N, P' N', fig. 42, be symmetrically arranged and insulated, and the ends N P' connected by a wire, over which a magnetic needle is suspended, the wire will exert no effect over the needle; but immediately that the ends P N' are connected by another wire, the needle will be deflected, and will remain so as long as the circuit is complete. Now if the troughs merely act by causing a peculiar arrangement in the wire either of its particles or its electricity, that arrangement constituting its electrical and magnetic state, then the wire N P' should be in a similar state of arrangement *before* P and N' were connected, to what it is afterwards, and should have deflected the needle, although less powerfully, perhaps to one half the extent which would result when the communication is complete throughout. But if the magnetic effects depend upon a current, then it is evident why they could not be produced in *any* degree before the circuit was complete; because prior to that no current could exist.

283. By *current*, I mean anything progressive, whether it be a fluid of electricity, or two fluids moving in opposite directions, or merely vibrations, or, speaking still more generally, progressive forces. By *arrangement*, I understand a local ad-

justment of particles, or fluids, or forces, not progressive. Many other reasons might be urged in support of the view of a *current* rather than an *arrangement*, but I am anxious to avoid stating unnecessarily what will occur to others at the moment.

II. *Ordinary Electricity.*

284. By ordinary electricity I understand that which can be obtained from the common machine, or from the atmosphere, or by pressure, or cleavage of crystals, or by a multitude of other operations; its distinctive character being that of great intensity, and the exertion of attractive and repulsive powers, not merely at sensible but at considerable distances.

285. *Tension.* The attractions and repulsions at sensible distances, caused by ordinary electricity, are well known to be so powerful in certain cases, as to surpass, almost infinitely, the similar phenomena produced by electricity, otherwise excited. But still those attractions and repulsions are exactly of the same nature as those already referred to under the head *Tension, Voltaic electricity* (268.); and the difference in degree between them is not greater than often occurs between cases of ordinary electricity only. I think it will be unnecessary to enter minutely into the proofs of the identity of this character in the two instances. They are abundant; are generally admitted as good; and lie upon the surface of the subject: and whenever in other parts of the comparison I am about to draw, a similar case occurs, I shall content myself with a mere announcement of the similarity, enlarging only upon those parts where the great question of distinction or identity still exists.

286. The discharge of common electricity through heated air is a well-known fact. The parallel case of voltaic electricity has already been described (272, &c.).

287. *In motion.* i. *Evolution of heat.*—The heating power of common electricity, when passed through wires or other substances, is perfectly well known. The accordance between it and voltaic electricity is in this respect complete. Mr. Harris has constructed and described* a very beautiful and sensible

* Philosophical Transactions, 1827, p. 18. Edinburgh Transactions, 1831 Harris on a New Electrometer, &c. &c.

instrument on this principle, in which the heat produced in a wire by the discharge of a small portion of common electricity is readily shown, and to which I shall have occasion to refer for experimental proof in a future part of this paper (344.).

288. ii. *Magnetism*.—Voltaic electricity has most extraordinary and exalted magnetic powers. If common electricity be identical with it, it ought to have the same powers. In rendering needles or bars magnetic, it is found to agree with voltaic electricity, and the *direction* of the magnetism, in both cases, is the same; but in deflecting the magnetic needle, common electricity has been found deficient, so that sometimes its power has been denied altogether, and at other times distinctions have been hypothetically assumed for the purpose of avoiding the difficulty*.

289. M. Colladon, of Geneva, considered that the difference might be due to the use of insufficient quantities of common electricity in all the experiments before made on this head; and in a memoir read to the Academie des Sciences in 1826†, describes experiments, in which, by the use of a battery, points, and a delicate galvanometer, he succeeded in obtaining deflections, and thus establishing identity in that respect. MM. Arago, Ampère, and Savary, are mentioned in the paper as having witnessed a successful repetition of the experiments. But as no other one has come forward in confirmation, MM. Arago, Ampère, and Savary, not having themselves published (that I am aware of) their admission of the results, and as some have not been able to obtain them, M. Colladon's conclusions have been occasionally doubted or denied; and an important point with me was to establish their accuracy, or remove them entirely from the body of received experimental research. I am happy to say that my results fully confirm those by M. Colladon, and I should have had no occasion to describe them, but that they are essential as proofs of the accuracy of the final and general conclusions I am enabled to draw respecting the magnetic and chemical action of electricity, (360. 366. 367. 377. &c.).

290. The plate electrical machine I have used is fifty inches

* Demonferrand's Manuel d'Electricité dynamique, p. 121.

† Annales de Chimie, xxxiii. p. 62.

in diameter; it has two sets of rubbers; its prime conductor consists of two brass cylinders connected by a third, the whole length being twelve feet, and the surface in contact with air about 1422 square inches. When in good excitation, one revolution of the plate will give ten or twelve sparks from the conductors, each an inch in length. Sparks or flashes from ten to fourteen inches in length may easily be drawn from the conductors. Each turn of the machine, when worked moderately, occupies about $\frac{4}{5}$ ths of a second.

291. The electric battery consisted of fifteen equal jars. They are coated eight inches upwards from the bottom, and are twenty-three inches in circumference, so that each contains one hundred and eighty-four square inches of glass, coated on both sides; this is independent of the bottoms, which are of thicker glass, and contain each about fifty square inches.

292. A good *discharging train* was arranged by connecting metallically a sufficiently thick wire with the metallic gas pipes of the house, with the metallic gas pipes belonging to the public gas works of London; and also with the metallic water pipes of London. It was so effectual in its office as to carry off instantaneously electricity of the feeblest tension, even that of a single voltaic trough, and was essential to many of the experiments.

293. The galvanometer was one or the other of those formerly described (87. 205.), but the glass jar covering it and supporting the needle was coated inside and outside with tin-foil, and the upper part (left uncoated, that the motions of the needle might be examined,) was covered with a frame of wire-work, having numerous sharp points projecting from it. When this frame and the two coatings were connected with the discharging train (292.), an insulated point or ball, connected with the machine when most active, might be brought within an inch of any part of the galvanometer, yet without affecting the needle within by ordinary electrical attraction or repulsion.

294. In connexion with these precautions it may be necessary to state that the needle of the galvanometer is very liable to have its magnetic power deranged, diminished, or even inverted by the passage of a shock through the instrument. If the needle be at all oblique, in the wrong direction, to the coils

of the galvanometer when the shock passes, effects of this kind are sure to happen.

295. It was to the retarding power of bad conductors, with the intention of diminishing its *intensity* without altering its *quantity*, that I first looked with the hope of being able to make common electricity assume more of the characters and power of voltaic electricity, than it is usually supposed to have.

296. The coating and armour of the galvanometer were first connected with the discharging train (292.); the end B (87.) of the galvanometer wire was connected with the outside coating of the battery, and then both these with the discharging train; the end A of the galvanometer wire was connected with a discharging rod by a wet thread four feet long; and, finally, when the battery (291.) had been positively charged by about forty turns of the machine, it was discharged by the rod and the thread through the galvanometer. The needle immediately moved.

297. During the time that the needle completed its vibration in the first direction and returned, the machine was worked, and the battery recharged; and when the needle in vibrating resumed its first direction, the discharge was again made through the galvanometer. By repeating this action a few times, the vibrations soon extended to above 40° on each side of the line of rest.

298. This effect could be obtained at pleasure. Nor was it varied, apparently, either in direction or degree, by using a short thick string, or even four short thick strings in place of the long fine thread. With a more delicate galvanometer, an excellent swing of the needle could be obtained by one discharge of the battery.

299. On reversing the galvanometer communications so as to pass the discharge through from B to A, the needle was equally well deflected, but in the opposite direction.

300. The deflections were in the same direction as if a voltaic current had been passed through the galvanometer, *i. e.* the positively charged surface of the electric battery coincided with the positive end of the voltaic apparatus (268.), and the negative surface of the former with the negative end of the latter.

301. The battery was then thrown out of use, and the communications so arranged that the current could be passed from the prime conductor, by the discharging rod held against it, through the wet string, through the galvanometer coil, and into the discharging train (292.), by which it was finally dispersed. This current could be stopped at any moment by removing the discharging rod, and either stopping the machine or connecting the prime conductor by another rod with the discharging train; and could be as instantly renewed. The needle was so adjusted, that whilst vibrating in moderate and small arcs, it required time equal to twenty-five beats of a watch to pass in one direction through the arc, and of course an equal time to pass in the other direction.

302. Thus arranged, and the needle being stationary, the current, direct from the machine, was sent through the galvanometer for twenty-five beats, then interrupted for other twenty-five beats, renewed for twenty-five beats more, again interrupted for an equal time, and so on continually. The needle soon began to vibrate visibly, and after several alternations of this kind the vibration increased to 40° or more.

303. On changing the direction of the current through the galvanometer, the direction of the deflection of the needle was also changed. In all cases the motion of the needle was in direction the same as that caused either by the use of the electric battery or a voltaic trough (300.).

304. I now rejected the wet string, and substituted a copper wire, so that the electricity of the machine passed at once into wires communicating directly with the discharging train, the galvanometer coil being one of the wires used for the discharge. The effects were exactly those obtained above (302.).

305. Instead of passing the electricity through the system, by bringing the discharging rod at the end of it into contact with the conductor, four points were fixed on to the rod; when the current was to pass they were held about twelve inches from the conductor, and when it was not to pass, they were turned away. Then operating as before (302.), except with this variation, the needle was soon powerfully deflected, and in perfect consistency with the former results. Points afforded the means by which Colladon, in all cases, made his discharges.

306. Finally, I passed the electricity first through an ex-

hausted receiver, so as to make it there resemble the aurora borealis, and then through the galvanometer to the earth; and it was found still effective in deflecting the needle, and apparently with the same force as before.

307. From all these experiments, it appears that a current of common electricity, whether transmitted through water or metal, or rarefied air, or by means of points in common air, is still able to deflect the needle; the only requisite being, apparently, to allow time for its action: that it is, in fact, just as magnetic in every respect as a voltaic current, and that in this character therefore no distinction exists.

308. Imperfect conductors, as water, brine, acids, &c. &c. will be found far more convenient for exhibiting these effects than other modes of discharge, as by points or balls; for the former convert at once the charge of a powerful battery into a feeble spark discharge, or rather continuous current, and involve little or no risk of deranging the magnetism of the needles (294.).

309. iii. *Chemical decomposition.*—The chemical action of voltaic electricity is characteristic of that agent, but not more characteristic than are the *laws* under which the bodies evolved by decomposition arrange themselves at the poles. Dr. Wollaston showed* that common electricity resembled it in these effects, and “that they are both essentially the same”; but he mingled with his proofs an experiment having a resemblance, and nothing more, to a case of voltaic decomposition, which however he himself partly distinguished; and this has been more frequently referred to by some, on the one hand, to prove the occurrence of electro-chemical decomposition, like that of the pile, and by others to throw doubt upon the whole paper, than the more numerous and decisive experiments which he has detailed.

310. I take the liberty of describing briefly my results, and of thus adding my testimony to that of Dr. Wollaston on the identity of voltaic and common electricity as to chemical action, not only that I may facilitate the repetition of the experiments, but also lead to some new consequences respecting electro-chemical decomposition (376. 377.).

311. I first repeated Wollaston's fourth experiment †, in

* Philosophical Transactions, 1801, p. 427, 434. † Ibid. 1801, p. 429.

which the ends of coated silver wires are immersed in a drop of sulphate of copper. By passing the electricity of the machine through such an arrangement, that end in the drop which received the electricity became coated with metallic copper. One hundred turns of the machine produced an evident effect; two hundred turns a very sensible one. The decomposing action was however very feeble. Very little copper was precipitated, and no sensible trace of silver from the other pole appeared in the solution.

312. A much more convenient and effectual arrangement for chemical decompositions by common electricity, is the following. Upon a glass plate, fig. 43, placed over, but raised above a piece of white paper, so that shadows may not interfere, put two pieces of tinfoil *a, b*; connect one of these by an insulated wire *c*, or wire and string (301.), with the machine, and the other *g*, with the discharging train (292.) or the negative conductor; provide two pieces of fine platina wire, bent as in fig. 44, so that the part *d, f* shall be nearly upright, whilst the whole is resting on the three bearing points *p, e, f*; place these as in fig. 43; the points *p, n* then become the decomposing poles. In this way surfaces of contact, as minute as possible, can be obtained at pleasure, and the connexion can be broken or renewed in a moment, and the substances acted upon examined with the utmost facility.

313. A coarse line was made on the glass with solution of sulphate of copper, and the terminations *p* and *n* put into it; the foil *a* was connected with the positive conductor of the machine by wire and wet string, so that no sparks passed: twenty turns of the machine caused the precipitation of so much copper on the end *n*, that it looked like copper wire; no apparent change took place at *p*.

314. A mixture of equal parts of muriatic acid and water was rendered deep blue by sulphate of indigo, and a large drop put on the glass, fig. 43, so that *p* and *n* were immersed at opposite sides: a single turn of the machine showed bleaching effects round *p*, from evolved chlorine. After twenty revolutions no effect of the kind was visible at *n*, but so much chlorine had been set free at *p*, that when the drop was stirred the whole became colourless.

315. A drop of solution of iodide of potassium mingled with

starch was put into the same position at *p* and *n*; on turning the machine, iodine was evolved at *p*, but not at *n*.

316. A still further improvement in this form of apparatus consists in wetting a piece of filtering paper in the solution to be experimented on, and placing that under the points *p* and *n*, on the glass: the paper retains the substance evolved at the point of evolution, by its whiteness renders any change of colour visible, and allows of the point of contact between it and the decomposing wires being contracted to the utmost degree. A piece of paper moistened in the solution of iodide of potassium and starch, or of the iodide alone, with certain precautions (322.), is a most admirable test of electro-chemical action; and when thus placed and acted upon by the electric current, will show iodide evolved at *p* by only half a turn of the machine. With these adjustments and the use of iodide of potassium on paper, chemical action is sometimes a more delicate test of electrical currents than the galvanometer (273.). Such cases occur when the bodies traversed by the current are bad conductors, or when the quantity of electricity evolved or transmitted in a given time is very small.

317. A piece of litmus paper moistened in solution of common salt of sulphate of soda, was quickly reddened at *p*. A similar piece moistened in muriatic acid was very soon bleached at *p*. No effects of a similar kind took place at *n*.

318. A piece of turmeric paper moistened in solution of sulphate of soda was reddened at *n* by two or three turns of the machine, and in twenty or thirty turns plenty of alkali was there evolved. On turning the paper round, so that the spot came under *p*, and then working the machine, the alkali soon disappeared, the place became yellow, and a brown alkaline spot appeared in the new part under *n*.

319. On combining a piece of litmus with a piece of turmeric paper, wetting both with solution of sulphate of soda, and putting the paper on the glass, so that *p* was on the litmus and *n* on the turmeric, a very few turns of the machine sufficed to show the evolution of acid at the former and alkali at the latter, exactly in the manner effected by a volta-electric current.

320. All these decompositions took place equally well, whether the electricity passed from the machine to the foil *a*, through water, or through wire only; by *contact* with the con-

ductor, or by *sparks* there; provided the sparks were not so large as to cause the electricity to pass in sparks from *p* to *n*, or towards *n*; and I have seen no reason to believe that in cases of true electro-chemical decomposition by the machine, the electricity passed in sparks from the conductor, or at any part of the current, is able to do more, because of its tension, than that which is made to pass merely as a regular current.

321. Finally, the experiment was extended into the following form, supplying in this case the fullest analogy between common and voltaic electricity. Three compound pieces of litmus and turmeric paper (319.) were moistened in solution of sulphate of soda, and arranged on a plate of glass with platina wires, as in fig. 45. The wire *m* was connected with the prime conductor of the machine, the wire *t* with the discharging train, and the wires *r* and *s* entered into the course of the electrical current by means of the pieces of moistened paper; they were so bent as to rest each on three points, *n, r, p*; *n, s, p*, the points *r* and *s* being supported by the glass, and the others by the papers: the three terminations *p, p, p* rested on the litmus, and the other three *n, n, n* on the turmeric paper. On working the machine for a short time only, acid was evolved at *all* the poles or terminations *p, p, p*, by which the electricity entered the solution, and alkali at the other poles, *n, n, n*, by which the electricity left the solution.

322. In all experiments of electro-chemical decomposition by the common machine and moistened papers (316.), it is necessary to be aware of and to avoid the following important source of error. If a spark passes over moistened litmus and turmeric paper, the litmus paper (provided it be delicate and not too alkaline,) is reddened by it; and if several sparks are passed, it becomes powerfully reddened. If the electricity pass a little way from the wire over the surface of the moistened paper, before it finds mass and moisture enough to conduct it, then the reddening extends as far as the ramifications. If similar ramifications occur at the termination *n*, on the turmeric paper, they *prevent* the occurrence of the red spot due to the alkali, which would otherwise collect there: sparks or ramifications from the points *n* will also redden litmus paper. If paper moistened by a solution of iodide of potassium (which is an admirably delicate test of electro-chemical action,) be exposed to

the sparks or ramifications, or even a feeble stream of electricity through the air from either the point *p* or *n*, iodine will be immediately evolved.

323. These effects must not be confounded with those due to the true electro-chemical powers of common electricity, and must be carefully avoided when the latter are to be observed. No sparks should be passed, therefore, in any part of the current, nor any increase of intensity allowed, by which the electricity may be induced to pass between the platina wires and the moistened papers, otherwise than by conduction; for if it burst through the air, the effect referred to above (322.) ensues.

324. The effect itself is due to the formation of nitric acid by the combination of the oxygen and nitrogen of the air, and is, in fact, only a delicate repetition of Cavendish's beautiful experiment. The acid so formed, though small in quantity, is in a high state of concentration as to water, and produces the consequent effects of reddening the litmus paper; or preventing the exhibition of alkali on the turmeric paper; or, by acting on the iodide of potassium, evolving iodine.

325. By moistening a very small slip of litmus paper in solution of caustic potassa, and then passing the electric spark over its length in the air, I gradually neutralized the alkali, and ultimately rendered the paper red; on drying it, I found that nitrate of potassa had resulted from the operation, and that the paper had become touch paper.

326. Either litmus paper or white paper, moistened in a strong solution of iodide of potassium, offers therefore a very simple, beautiful, and ready means of illustrating Cavendish's experiment of the formation of nitric acid from the atmosphere.

327. I have already had occasion to refer to an experiment (265. 309.) made by Dr. Wollaston, which is insisted upon too much, both by those who oppose and those who agree with the accuracy of his views respecting the identity of voltaic and ordinary electricity. By covering fine wires with glass or other insulating substances, and then removing only so much matter as to expose the point, or a section of the wires, and by passing electricity through two such wires, the guarded points of which were immersed in water, Wollaston found that the water could be decomposed even by the current from the machine, without sparks, and that two streams of gas arose from the points,

exactly resembling, in appearance, those produced by voltaic electricity, and, like the latter, giving a mixture of oxygen and hydrogen gases. But Dr. Wollaston himself points out that the effect is different from that of the voltaic pile, inasmuch as both oxygen and hydrogen are evolved from *each* pole; he calls it "a very close *imitation* of the galvanic phenomena," but adds that "in fact the resemblance is not complete," and does not trust to it to establish the principles correctly laid down in his paper.

328. This experiment is neither more nor less than a repetition, in a refined manner, of that made by Dr. Pearson in 1797*, and previously by MM. Paets Van Troostwyk and Deiman in 1789 or earlier. That the experiment should never be quoted as proving true electro-chemical decomposition, is sufficiently evident from the circumstance, that the *law* which regulates the transference and final place of the evolved bodies (278. 309.) has no influence here. The water is decomposed at both poles independently of each other, and the oxygen and hydrogen evolved at the wires are the elements of the water existing the instant before in those places. That the poles, or rather points, have no mutual decomposing dependence, may be shown by substituting a wire, or the finger, for one of them, a change which does not at all interfere with the other, though it stops all action at the changed pole. This fact may be observed by turning the machine for some time; for though bubbles will rise from the point left unaltered, in quantity sufficient to cover entirely the wire used for the other communication, if they could be applied to it, yet not a single bubble will appear on that wire.

329. When electro-chemical decomposition takes place, there is great reason to believe that the *quantity* of matter decomposed is not proportionate to the intensity, but to the quantity of electricity passed (320.). Of this I shall be able to offer some proofs in a future part of this paper (375. 377.). But in the experiment under consideration, this is not the case. If, with a constant pair of points, the electricity be passed from the machine in sparks, a certain proportion of gas is evolved; but if the sparks be rendered shorter, less gas is evolved; and if no sparks be passed, there is scarcely a sensible portion of

* Nicholson's Journal, 4to. vol. 1. pp. 241, 299, 349.

gases set free. On substituting solution of sulphate of soda for water, scarcely a sensible quantity of gas could be procured even with powerful sparks, and nearly none with the mere current; yet the quantity of electricity in a given time was the same in all these cases.

330. I do not intend to deny that with such an apparatus common electricity can decompose water in a manner analogous to that of the voltaic pile; I believe at present that it can. But when what I consider the true effect only was obtained, the quantity of gas given off was so small that I could not ascertain whether it was, as it ought to be, oxygen at one wire and hydrogen at the other. Of the two streams one seemed more copious than the other, and on turning the apparatus round, still the same side in relation to the machine gave the largest stream. On substituting solution of sulphate of soda for pure water (329.), these minute streams were still observed. But the quantities were so small, that on working the machine for half an hour I could not obtain at either pole a bubble of gas larger than a small grain of sand. If the conclusion which I have drawn (377.) relating to the amount of chemical action be correct, this ought to be the case.

331. I have been the more anxious to assign the true value of this experiment as a test of electro-chemical action, because I shall have occasion to refer to it in cases of supposed chemical action by magneto-electric and other electric currents (336. 346.) and elsewhere. But, independent of it, there cannot be now a doubt that Dr. Wollaston was right in his general conclusion; and that voltaic and common electricity have powers of chemical decomposition, alike in their nature, and governed by the same law of arrangement.

332. iv. *Physiological effects.*—The power of the common electric current to shock and convulse the animal system, and when weak to affect the tongue and the eyes, may be considered as the same with the similar power of voltaic electricity, account being taken of the intensity of the one electricity and duration of the other. When a wet thread was interposed in the course of the current of common electricity from the battery (291.) charged by eight or ten* revolutions of the machine in good action (290.) and the discharge made by platina spatulas through the tongue or the gums, the effect upon the tongue

* Or even from thirty to forty.

and eyes was exactly that of a momentary feeble voltaic circuit.

333. *v. Spark.*—The beautiful flash of light attending the discharge of common electricity is well known. It rivals in brilliancy, if it does not even very much surpass, the light from the discharge of voltaic electricity; but it endures for an instant only, and is attended by a sharp noise like that of a small explosion. Still no difficulty can arise in recognizing it to be the same spark as that from the voltaic battery, especially under certain circumstances. The eye cannot distinguish the difference between a voltaic and a common electricity spark, if they be taken between amalgamated surfaces of metal, at intervals only, and through the same distance of air.

334. When the Leyden battery (291.) was discharged through a wet string placed in some part of the circuit away from the place where the spark was to pass, the spark was yellowish, flamy, having a duration sensibly longer than if the water had not been interposed, was about three-fourths of an inch in length, was accompanied by little or no noise, and whilst losing part of its usual character had approximated in some degree to the voltaic spark. When the electricity retarded by water was discharged between pieces of chareoal, it was exceedingly luminous and bright upon both surfaces of the chareoal, resembling the brightness of the voltaic discharge on such surfaces. When the discharge of the unretarded electricity was taken upon chareoal, it was bright upon both the surfaces, (in that respect resembling the voltaic spark,) but the noise was loud, sharp, and ringing.

335. I have assumed, in accordance, I believe, with the opinion of every other philosopher, that atmospheric electricity is of the same nature with ordinary electricity (284.), and I might therefore refer to certain published statements of chemical effects produced by the former as proofs that the latter enjoys the power of decomposition in common with voltaic electricity. But the comparison I am drawing is far too rigorous to allow me to use these statements without being fully assured of their accuracy; yet I have no right to suppress them, because, if accurate, they establish what I am labouring to put on an undoubted foundation, and have priority to my results.

336. M. Bonijol of Geneva* is said to have constructed

* Bibliothèque Universelle, 1830, tome xlv. p. 213.

very delicate apparatus for the decomposition of water by common electricity. By connecting an insulated lightning rod with his apparatus, the decomposition of the water proceeded in a continuous and rapid manner even when the electricity of the atmosphere was not very powerful. The apparatus is not described; but as the diameter of the wire is mentioned as very small, it appears to have been similar in construction to that of Wollaston (327.); and as that does not furnish a case of true polar electro-chemical decomposition (328.), this result of M. Bonijol does not prove the identity in chemical action of common and voltaic electricity.

337. At the same page of the *Bibliothèque Universelle*, M. Bonijol is said to have decomposed *potash*, and also chloride of silver by putting them into very narrow tubes and passing electric sparks from an ordinary machine over them. It is evident that these offer no analogy to cases of true voltaic decomposition, where the electricity only decomposes when it is *conducted* by the body acted upon, and ceases to decompose, according to its ordinary laws, when it passes in sparks. These effects are probably partly analogous to that which takes place with water in Pearson's or Wollaston's apparatus, and may be due to very high temperature acting on minute portions of matter; or they may be connected with the results in air (322.). As nitrogen can combine directly with oxygen under the influence of the electric spark (324.), it is not impossible that it should even take it from the potassium of the potash, especially as there would be plenty of potassa in contact with the acting particles to combine with the nitric acid formed. However distinct all these actions may be from true polar electro-chemical decompositions, they are still highly important, and well worthy of investigation.

338. The late Mr. Barry communicated a paper to the Royal Society* last year, so distinct in the details, that it would seem at once to prove the identity in chemical action of common and voltaic electricity; but, when examined, considerable difficulty arises in reconciling certain of the effects with the remainder. He used two tubes, each having a wire within it passing through the closed end, as is usual for voltaic decompositions. The tubes were filled with solution of sulphate of soda, coloured with syrup of violets, and connected by a portion of the same

* *Philosophical Transactions*, 1831; p. 165.

solution, in the ordinary manner; the wire in one tube was connected by a *gilt thread* with the string of an insulated electrical kite, and the wire in the other tube by a similar *gilt thread* with the ground. Hydrogen soon appeared in the tube connected with the kite, and oxygen in the other, and in ten minutes the liquid in the first tube was green from the alkali evolved, and that in the other red from free acid produced. The only indication of the strength or intensity of the atmospheric electricity is in the expression, "the usual shocks were felt on touching the string."

339. That the electricity in this case does not resemble that from any ordinary source of common electricity, is shown by several circumstances. Wollaston could not effect the decomposition of water by such an arrangement, and obtain the gases in *separate* vessels, using common electricity; nor have any of the numerous philosophers, who have employed such an apparatus, obtained any such decomposition, either of water or of a neutral salt, by the use of the machine. I have lately tried the large machine (290.) in full action for a quarter of an hour, during which time seven hundred revolutions were made, without producing any sensible effects, although the shocks that it would then give must have been far more powerful and numerous than could have been taken, with any chance of safety, from an electrical kite-string; and by reference to the comparison hereafter to be made (371.), it will be seen that for common electricity to have produced the effect, the quantity must have been awfully great, and apparently far more than could have been conducted to the earth by a gilt thread, and at the same time only have produced the "usual shocks."

340. That the electricity was apparently not analogous to voltaic electricity is evident, for the "usual shocks" only were produced, and nothing like the terrible sensation due to a voltaic battery, even when it has a tension so feeble as not to strike through the eighth of an inch of air.

341. It seems just possible that the air which was passing by the kite and string, being in an electrical state sufficient to produce the "usual shocks" only, could still, when the electricity was drawn off below, renew the charge, and so continue the current. The string was 1500 feet long, and contained two double threads. But when the enormous quantity which must have been thus collected is considered (371. 376.), the expla-

nation seems very doubtful. I charged a voltaic battery of twenty pairs of plates four inches square with double coppers very strongly, insulated it, connected its positive extremity with the discharging train (292.), and its negative pole with an apparatus like that of Mr. Barry, communicating by a wire inserted three inches into the wet soil of the ground. This battery thus arranged produced feeble decomposing effects, as nearly as I could judge answering the description Mr. Barry has given. Its intensity was, of course, far lower than the electricity of the kite string, but the supply of quantity from the discharging train was unlimited. It gave no shocks to compare with the "usual shocks" of a kite-string.

342. Mr. Barry's experiment is a very important one to repeat and verify. If confirmed, it will be, as far as I am aware, the first recorded case of true electro-chemical decomposition of water by common electricity, and it will supply a form of electrical current, which, both in quantity and intensity, is exactly intermediate with those of the common electrical machine and the voltaic pile.

III. *Magneto-Electricity.*

343. *Tension.*—The attractions and repulsions due to the tension of ordinary electricity have been well observed with that evolved by magneto-electric induction. M. Pixii, by using an apparatus, clever in its construction and powerful in its action*, was able to obtain great divergence of the gold leaves of an electrometer †.

344. *In motion: i. Evolution of Heat.*—The current produced by magneto-electric induction can heat a wire in the manner of ordinary electricity. At the British Association of Science at Oxford, in June of the present year, I had the pleasure, in conjunction with Mr. Harris, Professor Daniell, Mr. Duncan, and others, of making an experiment, for which the great magnet in the museum, Mr. Harris's new electrometer (287.), and the magneto-electric coil described in my first paper (34.), were put in requisition. The latter had been modified in the manner I have elsewhere described ‡, so as to produce an electric spark when its contact with the magnet was made

* Annales de Chimie, l. p. 322.

† Ibid. li. p. 77.

‡ Phil. Mag. and Annals, 1832, vol. xi. p. 405.

or broken. The terminations of the spiral, adjusted so as to have their contact with each other broken when the spark was to pass, were connected with the wire in the electrometer, and it was found that each time the magnetic contact was made and broken, expansion of the air within the instrument occurred, indicating an increase, at the moment, of the temperature of the wire.

345. ii. *Magnetism*.—These currents were discovered by their magnetic power.

346. iii. *Chemical decomposition*.—I have made many endeavours to effect chemical decomposition by magneto-electricity, but unavailingly. In July last I received an anonymous letter (which has since been published*,) describing a magneto-electric apparatus, by which the decomposition of water was effected. As the term "guarded points" is used, I suppose the apparatus to have been Wollaston's (327. &c.), in which case the results did not indicate polar electro-chemical decomposition. Signor Botto has recently published certain results which he has obtained†; but they are, as at present described, inconclusive. The apparatus he used was apparently that of Dr. Wollaston, which gives only fallacious indications (327. &c.). As magneto-electricity can produce sparks, it would be able to show the effects proper to this apparatus. The apparatus of M. Pixii already referred to (343.) has however, in the hands of himself‡ and M. Haehette§, given decisive chemical results, so as to complete this link in the chain of evidence. Water was decomposed by it, and the oxygen and hydrogen obtained in separate tubes according to the law governing volta-electric and machine-electric decomposition.

347. iv. *Physiological effects*.—A frog was convulsed in the earliest experiments on these currents (56.). The sensation upon the tongue, and the flash before the eyes, which I at first obtained only in a feeble degree (56.), have been since exalted by more powerful apparatus, so as to become even disagreeable.

348. v. *Spark*.—The feeble spark which I first obtained with these currents (32.), has been varied and strengthened by Sig-

* Lond. and Edin. Phil. Mag. and Journ. 1832, vol. i. p. 161.

† Ibid. 1832, vol. i. p. 441.

‡ Annales de Chimie, li. p. 77.

§ Ibid. li. p. 72.

nor Nobili and Antinori, and others, so as to leave no doubt as to its identity with the common electric spark.

IV. *Thermo-Electricity.*

349. With regard to thermo-electricity, (that beautiful form of electricity discovered by Seebeck,) the very conditions under which it is excited are such as to give no ground for expecting that it can be raised like common electricity to any high degree of tension; the effects, therefore, due to that state are not to be expected. The sum of evidence respecting its analogy to the electricities already described, is, I believe, as follows:—*Tension.* The attractions and repulsions due to a certain degree of tension have not been observed. *In currents:* i. *Evolution of Heat.* I am not aware that its power of raising temperature has been observed. ii. *Magnetism.* It was discovered, and is best recognised, by its magnetic powers. iii. *Chemical decomposition* has not been effected by it. iv. *Physiological effects.* Nobili has shown* that these currents are able to cause contractions in the limbs of a frog. v. *Spark.* The spark has not yet been seen.

350. Only those effects are weak or deficient which depend upon a certain high degree of intensity; and if common electricity be reduced in that quality to a similar degree with the thermo-electricity, it can produce no effects beyond the latter.

V. *Animal Electricity.*

351. After an examination of the experiments of Walsh †, Ingenhousz ‡, Cavendish §, Sir H. Davy ||, and Dr. Davy ¶, no doubt remains on my mind as to the identity of the electricity of the torpedo with common and voltaic electricity; and I presume that so little will remain on the minds of others as to justify my refraining from entering at length into the philosophical proofs of that identity. The doubts raised by Sir H. Davy have been removed by his brother Dr. Davy; the results of the latter being the reverse of those of the former. At present the sum of evidence is as follows:—

* Bibliothèque Universelle, xxxvii. 15.

† Philosophical Transactions, 1773, p. 461.

§ Ibid. 1776, p. 196.

¶ Ibid. 1832, p. 259.

‡ Ibid. 1775, p. 1.

|| Ibid. 1829, p. 15.

352. *Tension*.—No sensible attractions or repulsions due to tension have been observed.

353. *In motion*: i. *Evolution of Heat*; not yet observed; I have little or no doubt that Harris's electrometer would show it (287. 359.).

354. ii. *Magnetism*.—Perfectly distinct. According to Dr. Davy*, the current deflected the needle and made magnets under the same law, as to direction, which governs currents of ordinary and voltaic electricity.

355. iii. *Chemical decomposition*.—Also distinct; and though Dr. Davy used an apparatus of similar construction with that of Dr. Wollaston (327.), still no error in the present case is involved, for the decompositions were polar, and in their nature truly electro-chemical. By the direction of the magnet, it was found that the under surface of the fish was negative, and the upper positive; and in the chemical decompositions, silver and lead were precipitated on the wire connected with the under surface and not on the other; and when these wires were either steel or silver, in solution of common salt, gas (hydrogen?) rose from the negative wire, but none from the positive.

356. Another reason for the decomposition being electro-chemical is, that a Wollaston's apparatus constructed with *wires*, coated with sealing wax, would most probably not have decomposed water, even in its own peculiar way, unless the electricity had risen high enough in intensity to produce sparks in some part of the circuit; whereas the torpedo was not able to produce sensible sparks. A third reason is, that the purer the water in Wollaston's apparatus, the more abundant is the decomposition: and I have found that a machine and wire points which succeeded perfectly well with distilled water, failed altogether when the water was rendered a good conductor by sulphate of soda, common salt, or other saline bodies. But in Dr. Davy's experiments with the torpedo, *strong* solutions of salt, nitrate of silver, and superacetate of lead were used successfully, and there is no doubt with more success than weaker ones.

357. iv. *Physiological effects*.—These are so characteristic, that by them the peculiar powers of the torpedo and gymnotus are principally recognised.

* Philosophical Transactions, 1832, p. 260.

358. v. *Spark*.—The electric spark has not yet been obtained, or at least I think not ; but perhaps I had better refer to the evidence on this point. Humboldt, speaking of results obtained by M. Fahlberg, of Sweden, says, “This philosopher has seen an electric spark, as Walsh and Ingenhousz had done before him at London, by placing the *gymnotus* in the air, and interrupting the conducting chain by two gold leaves pasted upon glass, and a line distant from each other*.” I cannot, however, find any record of such an observation by either Walsh or Ingenhousz, and do not know where to refer to that by M. Fahlberg. M. Humboldt could not himself perceive any luminous effect.

Again, Sir John Leslie, in his dissertation on the progress of mathematical and physical science, prefixed to the seventh edition of the *Encyclopædia Britannica*, Edinb. 1830, p. 622, says, “From a healthy specimen” of the *Silurus electricus*, meaning rather the *gymnotus*, “exhibited in London, vivid sparks were drawn in a darkened room” ; but he does not say he saw them himself, nor state who did see them ; nor can I find any account of such a phenomenon ; so that the statement is doubtful †.

359. In concluding this summary of the powers of torpedinal electricity, I cannot refrain from pointing out the enormous absolute quantity of electricity which the animal must put in circulation at each effort. It is doubtful whether any common electrical machine has as yet been able to supply electricity sufficient in a reasonable time to cause true electro-chemical decomposition of water (330. 339.), yet the current from the torpedo has done it. The same high proportion is shown by the magnetic effects (296. 371.) These circumstances indicate that the torpedo has power (in the way probably that Cavendish describes,) to continue the evolution for a sensible time, so that its successive discharges rather resemble those of a voltaic arrangement, intermitting in its action, than those of a Leyden apparatus, charged and discharged many times in succession. In reality, however, there is no *philosophical difference* between these two cases.

360. The *general conclusion* which must, I think, be drawn

* Edinburgh Phil. Journal, ii. p. 249.

† Mr. Brayley, who referred me to these statements, and has extensive knowledge of recorded facts, is unacquainted with any further account relating to them.

from this collection of facts is, that *electricity, whatever may be its source, is identical in its nature.* The phenomena in the five kinds or species quoted, differ, not in their character but only in degree; and in that respect vary in proportion to the variable circumstances of *quantity* and *intensity** which can at pleasure be made to change in almost any one of the kinds of electricity, as much as it does between one kind and another.

Table of the experimental Effects common to the Electricities derived from different Sources †.

	Physiological Effects.	Magnetic Deflection.	Magnets made.	Spark.	Heating Power.	True chemical Action.	Attraction and Repulsion.	Discharge by Hot Air.
1. Voltaic electricity . . .	×	×	×	×	×	×	×	×
2. Common electricity . . .	×	×	×	×	×	×	×	×
3. Magneto-Electricity . .	×	×	×	×	×	×	×	
4. Thermo-Electricity . . .	×	×	+	+	+	+		
5. Animal Electricity . . .	×	×	×	+	+	×		

§ 8. *Relation by Measure of common and voltaic Electricity.* †

361. Believing the point of identity to be satisfactorily established, I next endeavoured to obtain a common measure, or

* The term *quantity* in electricity is perhaps sufficiently definite as to sense; the term *intensity* is more difficult to define strictly. I am using the terms in their ordinary and accepted meaning.

† Many of the spaces in this table originally left blank may now be filled. Thus with *thermo-electricity*, Botto made magnets and obtained polar chemical decomposition: Antinori produced the spark; and if it has not been done before, Mr. Watkins has recently heated a wire in Harris's thermo-electrometer. In respect to *animal electricity*, Matteucci and Linari have obtained the spark from the torpedo, and I have recently procured it from the gymnotus: Dr. Davy has observed the heating power of the current from the torpedo. I have therefore filled up these spaces with crosses, in a different position to the others originally in the table. There remain but five spaces unmarked, two under *attraction* and *repulsion*, and three under *discharge by hot air*; and though these effects have not yet been obtained, it is a necessary conclusion that they must be possible, since the *spark* corresponding to them has been procured. For when a discharge across cold air can occur, that intensity which is the only essential additional requisite for the other effects must be present.—Dec. 13, 1838.

‡ In further illustration of this subject see 855-873 in Series VII.—Dec. 1838.

a known relation as to quantity, of the electricity excited by a machine, and that from a voltaic pile; for the purpose not only of confirming their identity (378.), but also of demonstrating certain general principles (366. 377, &c.), and creating an extension of the means of investigating and applying the chemical powers of this wonderful and subtle agent.

362. The first point to be determined was, whether the same absolute quantity of ordinary electricity, sent through a galvanometer, under different circumstances, would cause the same deflection of the needle. An arbitrary scale was therefore attached to the galvanometer, each division of which was equal to about 4° , and the instrument arranged as in former experiments (296.). The machine (290.), battery (291.), and other parts of the apparatus were brought into good order, and retained for the time as nearly as possible in the same condition. The experiments were alternated so as to indicate any change in the condition of the apparatus and supply the necessary corrections.

363. Seven of the battery jars were removed, and eight retained for present use. It was found that about forty turns would fully charge the eight jars. They were then charged by thirty turns of the machine, and discharged through the galvanometer, a thick wet string, about ten inches long, being included in the circuit. The needle was immediately deflected five divisions and a half, on the one side of the zero, and in vibrating passed as nearly as possible through five divisions and a half on the other side.

364. The other seven jars were then added to the eight, and the whole fifteen charged by thirty turns of the machine. The Henley's electrometer stood not quite half as high as before; but when the discharge was made through the galvanometer, previously at rest, the needle immediately vibrated, passing *exactly* to the same division as in the former instance. These experiments with eight and with fifteen jars were repeated several times alternately with the same results.

365. Other experiments were then made, in which all the battery was used, and its charge (being fifty turns of the machine,) sent through the galvanometer: but it was modified by being passed sometimes through a mere wet thread, sometimes through thirty-eight inches of thin string wetted by distilled water

and sometimes through a string of twelve times the thickness, only twelve inches in length, and soaked in dilute acid (298.). With the thick string the charge passed at once; with the thin string it occupied a sensible time, and with the thread it required two or three seconds before the electrometer fell entirely down. The current therefore must have varied extremely in intensity in these different cases, and yet the deflection of the needle was sensibly the same in all of them. If any difference occurred, it was that the thin string and thread caused greatest deflection; and if there is any lateral transmission, as M. Colladon says, through the silk in the galvanometer coil, it ought to have been so, because then the intensity is lower and the lateral transmission less.

366. Hence it would appear that *if the same absolute quantity of electricity pass through the galvanometer, whatever may be its intensity, the deflecting force upon the magnetic needle is the same.*

367. The battery of fifteen jars was then charged by sixty revolutions of the machine, and discharged, as before, through the galvanometer. The deflection of the needle was now as nearly as possible to the eleventh division, but the graduation was not accurate enough for me to assert that the arc was exactly double the former arc; to the eye it appeared to be so. The probability is, that *the deflecting force of an electric current is directly proportional to the absolute quantity of electricity passed, at whatever intensity that electricity may be**.

368. Dr. Ritchie has shown that in a case where the intensity of the electricity remained the same, the deflection of the magnetic needle was directly as the quantity of electricity passed through the galvanometer †. Mr. Harris has shown that the *heating power of common electricity on metallic wires is the same for the same quantity of electricity whatever its intensity might have previously been ‡.*

* The great and general value of the galvanometer, as an actual measure of the electricity passing through it, either continuously or interruptedly, must be evident from a consideration of these two conclusions. As constructed by Professor Ritchie with glass threads (see Philosophical Transactions, 1830, p. 218, and Quarterly Journal of Science, New Series, vol. i. p. 29), it apparently seems to leave nothing unsupplied in its own department.

† Quarterly Journal of Science, New Series, vol. i. p. 33.

‡ Plymouth Transactions, page 22.

369. The next point was to obtain a *voltaic* arrangement producing an effect equal to that just described (367). A platina and a zinc wire were passed through the same hole of a draw-plate, being then one eighteenth of an inch in diameter; these were fastened to a support, so that their lower ends projected, were parallel, and five sixteenths of an inch apart. The upper ends were well connected with the galvanometer wires. Some acid was diluted, and, after various preliminary experiments, that adopted as a standard which consisted of one drop strong sulphuric acid in four ounces distilled water. Finally, the time was noted which the needle required in swinging either from right to left or left to right: it was equal to seventeen beats of my watch, the latter giving one hundred and fifty in a minute. The object of these preparations was to arrange a voltaic apparatus, which, by immersion in a given acid for a given time, much less than that required by the needle to swing in one direction, should give equal deflection to the instrument with the discharge of ordinary electricity from the battery (363, 364.); and a new part of the zinc wire having been brought into position with the platina, the comparative experiments were made.

370. On plunging the zinc and platina wires five eighths of an inch deep into the acid, and retaining them there for eight beats of the watch, (after which they were quickly withdrawn,) the needle was deflected, and continued to advance in the same direction some time after the voltaic apparatus had been removed from the acid. It attained the five-and-a-half division, and then returned, swinging an equal distance on the other side. This experiment was repeated many times, and always with the same result.

371. Hence, as an approximation, and judging from *magnetic force* only at present (376.), it would appear that two wires, one of platina and one of zinc, each one eighteenth of an inch in diameter, placed five sixteenths of an inch apart and immersed to the depth of five eighths of an inch in acid, consisting of one drop oil of vitriol and four ounces distilled water, at a temperature about 60° , and connected at the other extremities by a copper wire eighteen feet long and one eighteenth of an inch thick (being the wire of the galvanometer coils), yield as much electricity in eight beats of my watch, or in $\frac{8}{175}$ ths of a minute, as the electrical battery charged by thirty turns of the

large machine, in excellent order (363. 364.). Notwithstanding this apparently enormous disproportion, the results are perfectly in harmony with those effects which are known to be produced by variations in the intensity and quantity of the electric fluid.

372. In order to procure a reference to *chemical action*, the wires were now retained immersed in the acid to the depth of five eighths of an inch, and the needle, when stationary, observed; it stood, as nearly as the unassisted eye could decide, at $5\frac{1}{3}$ division. Hence a permanent deflection to that extent might be considered as indicating a constant voltaic current, which in eight beats of my watch (369.), could supply as much electricity as the electrical battery charged by thirty turns of the machine.

373. The following arrangements and results are selected from many that were made and obtained relative to chemical action. A platina wire one twelfth of an inch in diameter, weighing two hundred and sixty grains, had the extremity rendered plain so as to offer a definite surface equal to a circle of the same diameter as the wire; it was then connected in turn with the conductor of the machine, or with the voltaic apparatus (369.), so as always to form the positive pole, and at the same time retain a perpendicular position, that it might rest, with its whole weight, upon the test paper to be employed. The test paper itself was supported upon a platina spatula, connected either with a discharging train (292.), or with the negative wire of the voltaic apparatus, and it consisted of four thicknesses, moistened at all times to an equal degree in a standard solution of hydriodate of potassa (316.).

374. When the platina wire was connected with the prime conductor of the machine, and the spatula with the discharging train, ten turns of the machine had such decomposing power as to produce a pale round spot of iodine of the diameter of the wire; twenty turns made a much darker mark, and thirty turns made a dark brown spot penetrating to the second thickness of the paper. The difference in effect produced by two or three turns, more or less, could be distinguished with facility.

375. The wire and spatula were then connected with the voltaic apparatus (369.) the galvanometer being also included in the arrangement; and, a stronger acid having been prepared,

consisting of nitric acid and water, the voltaic apparatus was immersed so far as to give a permanent deflection of the needle to the $5\frac{1}{3}$ division (372.), the fourfold moistened paper intervening as before.* Then by shifting the end of the wire from place to place upon the test paper, the effect of the current for five, six, seven, or any number of the beats of the watch (369.) was observed, and compared with that of the machine. After alternating and repeating the experiments of comparison many times, it was constantly found that this standard current of voltaic electricity, continued for eight beats of the watch, was equal, in chemical effect, to thirty turns of the machine; twenty-eight revolutions of the machine were sensibly too few.

376. Hence it results that both in *magnetic deflection* (371.) and in *chemical force*, the current of electricity of the standard voltaic battery for eight beats of the watch was equal to that of the machine evolved by thirty revolutions. *

377. It also follows that for this case of electro-chemical decomposition, and it is probable for all cases, that the *chemical power, like the magnetic force* (366.) *is in direct proportion to the absolute quantity of electricity* which passes.

378. Hence arises still further confirmation, if any were required, of the identity of common and voltaic electricity, and that the differences of intensity and quantity are quite sufficient to account for what were supposed to be their distinctive qualities.

379. The extension which the present investigations have enabled me to make of the facts and views constituting the theory of electro-chemical decomposition, will, with some other points of electrical doctrine, be almost immediately submitted to the Royal Society in another series of these Researches.

* Of course the heightened power of the voltaic battery was necessary to compensate for the bad conductor now interposed.

Royal Institution,
15th Dec. 1832.

NOTE.—I am anxious, and am permitted, to add to this paper a correction of an error which I have attributed to M. Ampère in the first series of these Experimental Researches. In referring to his experiment on the induction of electrical currents (78.), I have called that a disc which I should have called a

circle or a ring. M. Ampère used a ring, or a very short cylinder made of a narrow plate of copper bent into a circle, and he tells me that by such an arrangement the motion is very readily obtained. I have not doubted that M. Ampère obtained the motion he described; but merely mistook the kind of mobile conductor used, and so far I described his *experiment* erroneously.

In the same paragraph I have stated that M. Ampère says the disc turned "to take a position of equilibrium exactly as the spiral itself would have turned had it been free to move"; and further on I have said that my results tended to invert the sense of the proposition "stated by M. Ampère, *that a current of electricity tends to put the electricity of conductors near which it passes in motion in the same direction.*" M. Ampère tells me in a letter which I have just received from him, that he carefully avoided, when describing the experiment, any reference to the direction of the induced current; and on looking at the passages he quotes to me, I find that to be the case. I have therefore done him injustice in the above statements, and am anxious to correct my error.

But that it may not be supposed I lightly wrote those passages, I will briefly refer to my reasons for understanding them in the sense I did. At first the experiment failed. When re-made successfully about a year afterwards, it was at Geneva in company with M. A. De la Rive: the latter philosopher described the results*, and says that the plate of copper bent into a circle which was used as the mobile conductor "sometimes advanced between the two branches of the (horse-shoe) magnet, and sometimes was repelled, according to the direction of the current in the surrounding conductors."

I have been in the habit of referring to Demonferrand's *Manuel d'Electricité Dynamique*, as a book of authority in France; containing the general results and laws of this branch of science, up to the time of its publication, in a well-arranged form. At p. 173, the author when describing this experiment says, "The mobile circle turns to take a position of equilibrium as a conductor would do in which the current moved in the *same direction* as in the spiral;" and in the same paragraph he adds, "it is therefore proved *that a current of electricity tends to put the electricity of conductors, near which it passes, in motion in the same direction.*" These are the words I quoted in my paper (78.).

Le Lycée of 1st of January, 1832, No. 36, in an article written after the receipt of my first unfortunate letter to M. Hachette, and before my papers were printed, reasons upon the direction of the induced currents, and says, that there ought to be "an elementary current produced in the same direction as the corresponding portion of the producing current. A little further on it says, "therefore we ought to obtain currents, moving in the *same direction*, produced upon a metallic wire, either by a magnet or a current. M. Ampère was so thoroughly persuaded that such ought to be the direction of the currents by influence, that he neglected to assure himself of it in his experiment at Geneva."

It was the precise statements in Demonferrand's *Manuel*, agreeing as they did with the expression in M. De la Rive's paper, (which, however, I now understand as only meaning that when the inducing current was changed, the motion of the mobile circle changed also) and not in discordance with anything expressed by M. Ampère himself where he speaks of the experiment, which

* Bibliothèque Universelle, xxi. p. 48.

made me conclude, when I wrote the paper, that what I wrote was really his avowed opinion; and when the Number of the Lycée referred to appeared, which was before my paper was printed, it could excite no suspicion that I was in error.

Hence the mistake into which I unwittingly fell. I am proud to correct it and do full justice to the acuteness and accuracy which, as far as I can understand the subjects, M. Ampère carries into all the branches of philosophy which he investigates.

Finally, my note to (79.) says that the Lycée, No. 36, "mistakes the erroneous results of MM. Fresnel and Ampère for true ones," &c. &c. In calling M. Ampère's results erroneous, I spoke of the results described in, and referred to by the Lycée itself; but *now* that the expression of the direction of the induced current is to be separated, the term *erroneous* ought no longer to be attached to them.

April 29, 1833.

M. F.

FOURTH SERIES.

§ 9. *On a new Law of Electric Conduction.* § 10. *On Conducting Power generally.*

Received April 24,—Read May 23, 1833.

§ 9. *On a new Law of Electric Conduction**.

380. IT was during the progress of investigations relating to electro-chemical decomposition, which I still have to submit to the Royal Society, that I encountered effects due to a very *general law* of electric conduction not hitherto recognised; and though they prevented me from obtaining the condition I sought for, they afforded abundant compensation for the momentary disappointment, by the new and important interest which they gave to an extensive part of electrical science.

381. I was working with ice, and the solids resulting from the freezing of solutions, arranged either as barriers across a substance to be decomposed, or as the actual poles of a voltaic battery, that I might trace and catch certain elements in their transit, when I was suddenly stopped in my progress by finding that ice was in such circumstances a non-conductor of electricity; and that as soon as a thin film of it was interposed, in the circuit of a very powerful voltaic battery, the transmission of electricity was prevented, and all decomposition ceased.

382. At first the experiments were made with common ice, during the cold freezing weather of the latter end of January 1833; but the results were fallacious, from the imperfection of the arrangements, and the following more unexceptionable form of experiment was adopted.

383. Tin vessels were formed, five inches deep, one inch and a quarter wide in one direction, of different widths from three eighths to five eighths of an inch in the other, and open at one extremity. Into these were fixed by corks, plates of platina,

* In reference to this law see further considerations at 910. 1358. 1705.—*Dec.* 1838.

so that the latter should not touch the tin cases ; and copper wires having previously been soldered to the plates, these were easily connected, when required, with a voltaic pile. Then distilled water, previously boiled for three hours, was poured into the vessels, and frozen by a mixture of salt and snow, so that pure transparent solid ice intervened between the platina and tin : and finally these metals were connected with the opposite extremities of the voltaic apparatus, a galvanometer being at the same time included in the circuit.

384. In the first experiment, the platina pole was three inches and a half long, and seven eighths of an inch wide ; it was wholly immersed in the water or ice, and as the vessel was four eighths of an inch in width, the average thickness of the intervening ice was only a quarter of an inch, whilst the surface of contact with it at both poles was nearly fourteen square inches. After the water was frozen, the vessel was still retained in the frigorific mixture, whilst contact between the tin and platina respectively was made with the extremities of a well-charged voltaic battery, consisting of twenty pairs of four-inch plates, each with double coppers. Not the slightest deflection of the galvanometer needle occurred.

385. On taking the frozen arrangement out of the cold mixture, and applying warmth to the bottom of the tin case, so as to melt part of the ice, the connexion with the battery being in the mean time retained, the needle did not at first move ; and it was only when the thawing process had extended so far as to liquefy part of the ice touching the platina pole, that conduction took place ; but then it occurred effectually, and the galvanometer needle was permanently deflected nearly 70° .

386. In another experiment, a platina spatula, five inches in length and seven eighths of an inch in width, had four inches fixed in the ice, and the latter was only three sixtenths of an inch thick between one metallic surface and the other ; yet this arrangement insulated as perfectly as the former.

387. Upon pouring a little water in at the top of this vessel on the ice, still the arrangement did not conduct ; yet fluid water was evidently there. This result was the consequence of the cold metals having frozen the water where they touched it, and thus insulating the fluid part ; and it well illustrates the non-conducting power of ice, by showing how thin a film

could prevent the transmission of the battery current. Upon thawing parts of this thin film, at *both* metals, conduction occurred.

388. Upon warming the tin case and removing the piece of ice, it was found that a cork having slipped, one of the edges of the platina had been all but in contact with the inner surface of the tin vessel; yet, notwithstanding the extreme thinness of the interfering ice in this place, no sensible portion of electricity had passed.

389. These experiments were repeated many times with the same results. At last a battery of fifteen troughs, or one hundred and fifty pairs of four-inch plates, powerfully charged, was used; yet even here no sensible quantity of electricity passed the thin barrier of ice.

390. It seemed at first as if occasional departures from these effects occurred; but they could always be traced to some interfering circumstances. The water should in every instance be well frozen; for though it is not necessary that the ice should reach from pole to pole, since a barrier of it about one pole would be quite sufficient to prevent conduction, yet, if part remain fluid, the mere necessary exposure of the apparatus to the air, or the approximation of the hands, is sufficient to produce, at the *upper surface* of the water and ice, a film of fluid, extending from the platina to the tin; and then conduction occurs. Again, if the corks used to block the platina in its place are damp or wet within, it is necessary that the cold be sufficiently well applied to freeze the water in them, or else when the surfaces of their contact with the tin become slightly warm by handling, that part will conduct, and the interior being ready to conduct also, the current will pass. The water should be pure, not only that unembarrassed results may be obtained, but also that, as the freezing proceeds, a minute portion of concentrated saline solution may not be formed, which remaining fluid, and being interposed in the ice, or passing into cracks resulting from contraction, may exhibit conducting powers independent of the ice itself.

391. On one occasion I was surprised to find that after thawing much of the ice the conducting power had not been restored; but I found that a cork which held the wire just where it joined the platina, dipped so far into the ice, that with the ice itself

it protected the platina from contact with the melted part long after that contact was expected.

392. This insulating power of ice is not effective with electricity of exalted intensity. On touching a diverged gold-leaf electrometer with a wire connected with the platina, whilst the tin case was touched by the hand or another wire, the electrometer was instantly discharged (419.).

393. But though electricity of an intensity so low that it cannot diverge the electrometer, can still pass (though in very limited quantities (419.)) through ice; the comparative relation of water and ice to the electricity of the voltaic apparatus is not less extraordinary on that account, or less important in its consequences.

394. As it did not seem likely that this *law of the assumption of conducting power during liquefaction, and loss of it during congelation*, would be peculiar to water, I immediately proceeded to ascertain its influence in other cases, and found it to be very general. For this purpose bodies were chosen which were solid at common temperatures, but readily fusible; and of such composition as, for other reasons connected with electrochemical action, led to the conclusion that they would be able when fused to replace water as conductors. A voltaic battery of two troughs, or twenty pairs of four-inch plates (384.), was used as the source of electricity, and a galvanometer introduced into the circuit to indicate the presence or absence of a current.

395. On fusing a little chloride of lead by a spirit-lamp on a fragment of a Florence flask, and introducing two platina wires connected with the poles of the battery, there was instantly powerful action, the galvanometer was most violently affected, and the chloride rapidly decomposed. On removing the lamp, the instant the chloride solidified all current and consequent effects ceased, though the platina wires remained inclosed in the chloride not more than the one-sixteenth of an inch from each other. On renewing the heat, as soon as the fusion had proceeded far enough to allow liquid matter to connect the poles, the electrical current instantly passed.

396. On fusing the chloride, with one wire introduced, and then touching the liquid with the other, the latter being cold, caused a little knob to congregate on its extremity, and no current

passed ; it was only when the wire became so hot as to be able to admit or allow of contact with the liquid matter, that conduction took place, and then it was very powerful.

397. When chloride of silver and chlorate of potassa were experimented with, in a similar manner, exactly the same results occurred.

398. Whenever the current passed in these cases, there was decomposition of the substances ; but the electro-chemical part of this subject I purpose connecting with more general views in a future paper*.

399. Other substances, which could not be melted on glass, were fused by the lamp and blowpipe on platina connected with one pole of the battery, and then a wire, connected with the other, dipped into them. In this way chloride of sodium, sulphate of soda, protoxide of lead, mixed carbonates of potash and soda, &c. &c., exhibited exactly the same phenomena as those already described : whilst liquid, they conducted and were decomposed ; whilst solid, though very hot, they insulated the battery current even when four troughs were used.

400. Occasionally the substances were contained in small bent tubes of green glass, and when fused, the platina poles introduced, one on each side. In such cases the same general results

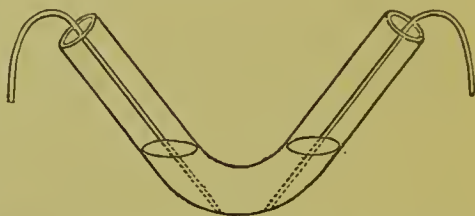

as those already described were procured ; but a further advantage was obtained, namely, that whilst the substance was conducting and suffering decomposition, the final arrangement of the elements could be observed. Thus, iodides of potassium and lead gave iodine at the positive pole, and potassium or lead at the negative pole. Chlorides of lead and silver gave chlorine at the positive, and metals at the negative pole.

* In 1801, Sir H. Davy knew that "dry nitre, caustic potash, and soda are conductors of galvanism when rendered fluid by a high degree of heat," (*Journals of the Royal Institution*, 1802, p. 53,) but was not aware of the general law which I have been engaged in developing. It is remarkable, that eleven years after that, he should say, "There are no fluids known except such as contain water, which are capable of being made the medium of connexion between the metal or metals of the voltaic apparatus." *Elements of Chemical Philosophy*, p. 169.

Nitre and chlorate of potassa gave oxygen, &c., at the positive, and alkali, or even potassium, at the negative pole.

401. A fourth arrangement was used for substances requiring very high temperatures for their fusion. A platina wire was connected with one pole of the battery; its extremity bent into a small ring, in the manner described by Berzelius, for blow-pipe experiments; a little of the salt, glass, or other substance, was melted on this ring by the ordinary blowpipe, or even in some cases by the oxy-hydrogen blowpipe, and when the drop, retained in its place by the ring, was thoroughly hot and fluid, a platina wire from the opposite pole of the battery was made to touch it, and the effects observed.

402. The following are various substances, taken from very different classes chemically considered, which are subject to this law. The list might, no doubt, be enormously extended; but I have not had time to do more than confirm the law by a sufficient number of instances.

First, *water*.

Amongst *oxides*;—potassa, protoxide of lead, glass of antimony, protoxide of antimony, oxide of bismuth.

Chlorides of potassium, sodium, barium, strontium, calcium, magnesium, manganese, zinc, copper (proto-), lead, tin (proto-), antimony, silver.

Iodides of potassium, zinc and lead, protiodide of tin, periodide of mercury; *fluoride* of potassium; *cyanide* of potassium; *sulpho-cyanide* of potassium.

Salts. Chlorate of potassa; nitrates of potassa, soda, baryta, strontia, lead, copper, and silver; sulphates of soda and lead, proto-sulphate of mercury; phosphates of potassa, soda, lead, copper, phosphoric glass or acid phosphate of lime; carbonates of potassa and soda, mingled and separate; borax, borate of lead, per-borate of tin; chromate of potassa, bi-chromate of potassa, chromate of lead; acetate of potassa.

Sulphurets. Sulphuret of antimony, sulphuret of potassium made by reducing sulphate of potassa by hydrogen; ordinary sulphuret of potassa.

Silicated potassa; chameleon mineral.

403. It is highly interesting in the instances of those substances which soften before they liquefy, to observe at what period the conducting power is acquired, and to what degree

it is exalted by perfect fluidity. Thus, with the borate of lead, when heated by the lamp upon glass, it becomes as soft as treacle, but it did not conduct, and it was only when urged by the blowpipe and brought to a fair red heat, that it conducted. When rendered quite liquid, it conducted with extreme facility.

404. I do not mean to deny that part of the increased conducting power in these cases of softening was probably due to the elevation of temperature (432. 445.); but I have no doubt that by far the greater part was due to the influence of the general law already demonstrated, and which in these instances came gradually, instead of suddenly, into operation.

405. The following are bodies which acquired no conducting power upon assuming the liquid state:—

Sulphur, phosphorus; iodide of sulphur, per-iodide of tin; orpiment, realgar; glacial acetic acid, mixed margaric and oleic acids, artificial camphor; caffeine, sugar, adipocire, stearine of cocoa-nut oil, spermaceti, camphor, naphthaline, resin, gum sandarach, shell lac.

406. Perchloride of tin, chloride of arsenic, and the hydrated chloride of arsenic, being liquids, had no sensible conducting power indicated by the galvanometer, nor were they decomposed.

407. Some of the above substances are sufficiently remarkable as exceptions to the general law governing the former cases. These are orpiment, realgar, acetic acid, artificial camphor, per-iodide of tin, and the chlorides of tin and arsenic. I shall have occasion to refer to these cases in the paper on Electro-chemical Decomposition.

408. Boracic acid was raised to the highest possible temperature by an oxy-hydrogen flame (401.), yet it gained no conducting powers sufficient to affect the galvanometer, and underwent no apparent voltaic decomposition. It seemed to be quite as bad a conductor as air. Green bottle-glass, heated in the same manner, did not gain conducting power sensible to the galvanometer. Flint glass, when highly heated, did conduct a little and decompose; and as the proportion of potash or oxide of lead was increased in the glass, the effects were more powerful. Those glasses, consisting of boracic acid on the one hand, and oxide of lead or potassa on the other, show the assumption of

conducting power upon fusion and the accompanying decomposition very well.

409. I was very anxious to try the general experiment with sulphuric acid, of about specific gravity 1.783, containing that proportion of water which gives it the power of crystallizing at 40° Fahr. ; but I found it impossible to obtain it so that I could be sure the whole would congeal even at 0° Fahr. A ten-thousandth part of water, more or less than necessary, would, upon cooling the whole, cause a portion of uncongealable liquid to separate, and that remaining in the interstices of the solid mass, and moistening the planes of division, would prevent the correct observation of the phenomena due to entire solidification and subsequent liquefaction.

410. With regard to the substances on which conducting power is thus conferred by liquidity, the degree of power so given is generally very great. Water is that body in which this acquired power is feeblest. In the various oxides, chlorides, salts, &c., &c., it is given in a much higher degree. I have not had time to measure the conducting power in these cases, but it is apparently some hundred times that of pure water. The increased conducting power known to be given to water by the addition of salts, would seem to be in a great degree dependent upon the high conducting power of these bodies when in the liquid state, that state being given them for the time, not by heat but solution in the water*.

411. Whether the conducting power of these liquefied bodies is a consequence of their decomposition or not (413.), or whether the two actions of conduction and decomposition are essentially connected or not, would introduce no difference affecting the probable accuracy of the preceding statement.

412. This *general assumption of conducting power* by bodies as soon as they pass from the solid to the liquid state, offers a new and extraordinary character, the existence of which, as far as I know, has not before been suspected; and it seems importantly connected with some properties and relations of the particles of matter which I may now briefly point out.

413. In almost all the instances, as yet observed, which are governed by this law, the substances experimented with have been those which were not only compound bodies, but such as

* See a doubt on this point at 1356.—*Dec.* 1838.

contain elements known to arrange themselves at the opposite poles; and were also such as could be *decomposed* by the electrical current. When conduction took place, decomposition occurred; when decomposition ceased, conduction ceased also; and it becomes a fair and an important question, Whether the conduction itself may not, wherever the law holds good, be a consequence not merely of the capability, but of the act of decomposition? And that question may be accompanied by another, namely, Whether solidification does not prevent conduction, merely by chaining the particles to their places, under the influence of aggregation, and preventing their final separation in the manner necessary for decomposition?

414. But, on the other hand, there is one substance (and others may occur), the *per-iodide of mercury*, which, being experimented with like the others (400.), was found to insulate when solid, and to acquire conducting power when fluid; yet it did not seem to undergo decomposition in the latter case.

415. Again, there are many substances which contain elements such as would be expected to arrange themselves at the opposite poles of the pile, and therefore in that respect fitted for decomposition, which yet do not conduct. Amongst these are the iodide of sulphur, per-iodide of zinc, per-chloride of tin, chloride of arsenic, hydrated chloride of arsenic, acetic acid, orpiment, realgar, artificial camphor, &c.; and from these it might perhaps be assumed that decomposition is dependent upon conducting power, and not the latter upon the former. The true relation, however, of conduction and decomposition in those bodies governed by the general law which it is the object of this paper to establish, can only be satisfactorily made out from a far more extensive series of observations than those I have yet been able to supply*.

416. The relation, under this law, of the conducting power for electricity to that for heat, is very remarkable, and seems to imply a natural dependence of the two. As the solid becomes a fluid, it loses almost entirely the power of conduction for heat, but gains in a high degree that for electricity; but as it reverts back to the solid state, it gains the power of conducting heat, and loses that of conducting electricity. If, therefore, the properties are not incompatible, still they are most strongly

* See 679, &c. &c.—Dec. 1838.

contrasted, one being lost as the other is gained. We may hope, perhaps, hereafter to understand the physical reason of this very extraordinary relation of the two conducting powers, both of which appear to be directly connected with the corpuscular condition of the substances concerned.

417. The assumption of conducting power and a decomposable condition by liquefaction, promises new opportunities of, and great facilities in, voltaic decomposition. Thus, such bodies as the oxides, chlorides, cyanides, sulpho-cyanides, fluorides, certain vitreous mixtures, &c. &c., may be submitted to the action of the voltaic battery under new circumstances; and indeed I have already been able, with ten pairs of plates, to decompose common salt, chloride of magnesium, borax, &c. &c., and to obtain sodium, magnesium, boron, &c., in their separate states.

§ 10. *On Conducting Power generally**.

418. It is not my intention here to enter into an examination of all the circumstances connected with conducting power, but to record certain facts and observations which have arisen during recent inquiries, as additions to the general stock of knowledge relating to this point of electrical science.

419. I was anxious, in the first place, to obtain some idea of the conducting power of ice and solid salts for electricity of high tension (392.), that a comparison might be made between it and the large accession of the same power gained upon liquefaction. For this purpose the large electrical machine (290.) was brought into excellent action, its conductor connected with a delicate gold-leaf electrometer, and also with the platina enclosed in the ice (383.), whilst the tin case was connected with the discharging train (292.). On working the machine moderately, the gold leaves barely separated; on working it rapidly, they could be opened nearly two inches. In this instance the tin case was five eighths of an inch in width; and as, after the experiment, the platina plate was found very nearly in the middle of the ice, the average thickness of the latter had been five sixteenths of an inch, and the extent of surface of contact with tin and platina fourteen square inches (384.). Yet, under

* In reference to this § refer to 983 in series viii., and the results connected with it.—*Dec.* 1838.

these circumstances, it was but just able to conduct the small quantity of electricity which this machine could evolve (371.), even when of a tension competent to open the leaves two inches ; no wonder, therefore, that it could not conduct any sensible portion of the electricity of the troughs (384.), which, though almost infinitely surpassing that of the machine in quantity, had a tension so low as not to be sensible to an electrometer.

420. In another experiment, the tin case was only four eighths of an inch in width, and it was found afterwards that the platina had been not quite one eighth of an inch distant in the ice from one side of the tin vessel. When this was introduced into the course of the electricity from the machine (419.), the gold leaves could be opened, but not more than half an inch ; the thinness of the ice favouring the conduction of the electricity, and permitting the same quantity to pass in the same time, though of a much lower tension.

421. Iodide of potassium which had been fused and cooled was introduced into the course of the electricity from the machine. There were two pieces, each about a quarter of an inch in thickness, and exposing a surface on each side equal to about half a square inch ; these were placed upon platina plates, one connected with the machine and electrometer (419.), and the other with the discharging train, whilst a fine platina wire connected the two pieces, resting upon them by its two points. On working the electrical machine, it was possible to open the electrometer leaves about two thirds of an inch.

422. As the platina wire touched only by points, the facts show that this salt is a far better conductor than ice ; but as the leaves of the electrometer opened, it is also evident with what difficulty conduction, even of the small portion of electricity produced by the machine, is effected by this body in the solid state, when compared to the facility with which enormous quantities at very low tensions are transmitted by it when in the fluid state.

423. In order to confirm these results by others, obtained from the voltaic apparatus, a battery of one hundred and fifty plates, four inches square, was well charged : its action was good ; the shock from it strong ; the discharge would *continue* from copper to copper through four tenths of an inch of air,

and the gold-leaf electrometer before used could be opened nearly a quarter of an inch.

424. The ice vessel employed (420.) was half an inch in width: as the extent of contact of the ice with the tin and platina was nearly fourteen square inches, the whole was equivalent to a plate of ice having a surface of seven square inches of perfect contact at each side, and only one fourth of an inch thick. It was retained in a freezing mixture during the experiment.

425. The order of arrangement in the course of the electric current was as follows. The positive pole of the battery was connected by a wire with the platina plate in the ice; the plate was in contact with the ice, the ice with the tin jacket, the jacket with a wire, which communicated with a piece of tin foil, on which rested one end of a bent platina wire (312.), the other or decomposing end being supported on paper moistened with solution of iodide of potassium (316.): the paper was laid flat on a platina spatula connected with the negative end of the battery. All that part of the arrangement between the ice-vessel and the decomposing wire point, including both these, was insulated, so that no electricity might pass through the latter which had not traversed the former also.

426. Under these circumstances, it was found that a pale brown spot of iodine was slowly formed under the decomposing platina point, thus indicating that ice could conduct a little of the electricity evolved by a voltaic battery charged up to the degree of intensity indicated by the electrometer. But it is quite evident that notwithstanding the enormous quantity of electricity which the battery could furnish, it was, under present circumstances, a very inferior instrument to the ordinary machine; for the latter could send as much through the ice as it could carry, being of a far higher intensity, *i. e.* able to open the electrometer leaves half an inch or more (419. 420.).

427. The decomposing wire and solution of iodide of potassium were then removed, and replaced by a very delicate galvanometer (205.); it was so nearly astatic, that it vibrated to and fro in about sixty-three beats of a watch giving one hundred and fifty beats in a minute. The same feebleness of current as before was still indicated; the galvanometer needle was deflected, but it required to break and make contact three or four times (297.), before the effect was decided.

428. The galvanometer being removed, two platina plates were connected with the extremities of the wires, and the tongue placed between them, so that the whole charge of the battery, so far as the ice would let it pass, was free to go through the tongue. Whilst standing on the stone floor, there was shock, &c., but when insulated, I could feel no sensation. I think a frog would have been scarcely, if at all, affected.

429. The ice was now removed, and experiments made with other solid bodies, for which purpose they were placed under the end of the decomposing wire instead of the solution of iodide of potassium (425.). For instance, a piece of dry iodide of potassium was placed on the spatula connected with the negative pole of the battery, and the point of the decomposing wire placed upon it, whilst the positive end of the battery communicated with the latter. A brown spot of iodine very slowly appeared, indicating the passage of a little electricity, and agreeing in that respect with the results obtained by the use of the electrical machine (421.). When the galvanometer was introduced into the circuit at the same time with the iodide, it was with difficulty that the action of the current on it could be rendered sensible.

430. A piece of common salt previously fused and solidified being introduced into the circuit was sufficient almost entirely to destroy the action on the galvanometer. Fused and cooled chloride of lead produced the same effect. The conducting power of these bodies *when fluid*, is very great (395. 402.).

431. These effects, produced by using the common machine and the voltaic battery, agree therefore with each other, and with the law laid down in this paper (394.); and also with the opinion I have supported, in the Third Series of these Researches, of the identity of electricity derived from different sources (360.).

432. The effect of heat in increasing the conducting power of many substances, especially for electricity of high tension, is well known. I have lately met with an extraordinary ease of this kind, for electricity of low tension, or that of the voltaic pile, and which is in direct contrast with the influence of heat upon metallic bodies, as observed and described by Sir Humphry Davy*.

433. The substance presenting this effect is sulphuret of sil-

* Philosophical Transactions, 1821, p. 431.

ver. It was made by fusing a mixture of precipitated silver and sublimed sulphur, removing the film of silver by a file from the exterior of the fused mass, pulverizing the sulphuret, mingling it with more sulphur, and fusing it again in a green glass tube, so that no air should obtain access during the process. The surface of the sulphuret being again removed by a file or knife, it was considered quite free from uncombined silver.

434. When a piece of this sulphuret, half an inch in thickness, was put between surfaces of platina, terminating the poles of a voltaic battery of twenty pairs of four-inch plates, a galvanometer being also included in the circuit, the needle was slightly deflected, indicating a feeble conducting power. On pressing the platina poles and sulphuret together with the fingers, the conducting power increased as the whole became warm. On applying a lamp under the sulphuret between the poles, the conducting power rose rapidly with the heat, and at last the galvanometer needle jumped into a fixed position, and the sulphuret was found conducting in the manner of a metal. On removing the lamp and allowing the heat to fall, the effects were reversed, the needle at first began to vibrate a little, then gradually left its transverse direction, and at last returned to a position very nearly that which it would take when no current was passing through the galvanometer.

435. Occasionally, when the contact of the sulphuret with the platina poles was good, the battery freshly charged, and the commencing temperature not too low, the mere current of electricity from the battery was sufficient to raise the temperature of the sulphuret; and then, without any application of extraneous heat, it went on increasing conjointly in temperature and conducting power, until the cooling influence of the air limited the effects. In such cases it was generally necessary to cool the whole purposely, to show the returning series of phenomena.

436. Occasionally, also, the effects would sink of themselves, and could not be renewed until a fresh surface of the sulphuret had been applied to the positive pole. This was in consequence of peculiar results of decomposition, to which I shall have occasion to revert in the section on Electro-chemical Decomposition, and was conveniently avoided by inserting the ends of two pieces of platina wire into the opposite extremities of a

portion of sulphuret fused in a glass tube, and placing this arrangement between the poles of the battery.

437. The hot sulphuret of silver conducts sufficiently well to give a bright spark with charcoal, &c. &c., in the manner of a metal.

438. The native grey sulphuret of silver, and the ruby silver ore, both presented the same phenomena. The native malleable sulphuret of silver presented precisely the same appearances as the artificial sulphuret.

439. There is no other body with which I am acquainted, that, like sulphuret of silver, can compare with metals in conducting power for electricity of low tension when hot, but which, unlike them, during cooling, loses in power, whilst they, on the contrary, gain. Probably, however, many others may, when sought for, be found*.

440. The proto-sulphuret of iron, the native per-sulphuret of iron, arsenical sulphuret of iron, native yellow sulphuret of copper and iron, grey artificial sulphuret of copper, artificial sulphuret of bismuth, and artificial grey sulphuret of tin, all conduct the voltaic battery current when cold, more or less, some giving sparks like the metals, others not being sufficient for that high effect. They did not seem to conduct better when heated, than before; but I had not time to enter accurately into the investigation of this point. Almost all of them became much heated by the transmission of the current, and present some very interesting phenomena in that respect. The sulphuret of antimony does not conduct the same current sensibly either hot or cold, but is amongst those bodies acquiring conducting power when fused (402.). The sulphuret of silver and perhaps some others decompose whilst in the solid state; but the phenomena of this decomposition will be reserved for its proper place in the next series of these Researches.

441. Notwithstanding the extreme dissimilarity between sulphuret of silver and gases or vapours, I cannot help suspecting the action of heat upon them to be the same, bringing them all into the same class as conductors of electricity, although with those great differences in degree, which are found to exist under common circumstances. When gases are heated, they increase in conducting power, both for common and voltaic elec-

* See now on this subject, 1340, 1341.—*Dec.* 1838.

tricity (271.) ; and it is probable that if we could compress and condense them at the same time, we should still further increase their conducting power. Cagniard de la Tour has shown that a substance, for instance, water, may be so expanded by heat whilst in the liquid state, or condensed whilst in the vaporous state, that the two states shall coincide at one point, and the transition from one to the other be so gradual that no line of demarcation can be pointed out*; that, in fact, the two states shall become one ;—which one state presents us at different times with differences in degree as to certain properties and relations ; and which differences are, under ordinary circumstances, so great as to be equivalent to two different states.

442. I cannot but suppose at present that at that point where the liquid and the gaseous state coincide, the conducting properties are the same for both ; but that they diminish as the expansion of the matter into a rarer form takes place by the removal of the necessary pressure ; still, however, retaining, as might be expected, the capability of having what feeble conducting power remains, increased by the action of heat.

443. I venture to give the following summary of the conditions of electric conduction in bodies, not however, without fearing that I may have omitted some important points†.

444. All bodies conduct electricity in the same manner from metals to acids and gases, but in very different degrees.

445. Conducting power is in some bodies powerfully increased by heat, and in others diminished, yet without our perceiving any accompanying essential electrical difference, either in the bodies or in the changes occasioned by the electricity conducted.

446. A numerous class of bodies, insulating electricity of low intensity, when solid, conduct it very freely when fluid, and are then decomposed by it.

447. But there are many fluid bodies which do not sensibly conduct electricity of this low intensity ; there are some which conduct it and are not decomposed ; nor is fluidity essential to decomposition‡.

* *Annales de Chimie*, xxi. pp. 127, 178.

† See now in relation to this subject, 1320—1342.—*Dec.* 1838.

‡ See the next series of these Experimental Researches.

448. There is but one body yet discovered* which, insulating a voltaic current when solid, and conducting it when fluid, is not decomposed in the latter case (414.).

449. There is no strict electrical distinction of conduction which can, as yet, be drawn between bodies supposed to be elementary, and those known to be compounds.

* It is just possible that this case may, by more delicate experiment, hereafter disappear. (See now, 1340, 1341, in relation to this note.—*Dec.* 1838.)

Royal Institution,

April 15, 1833.

FIFTH SERIES.

- § 11. *On Electro-chemical Decomposition.* ¶ i. *New conditions of Electro-chemical Decomposition.* ¶ ii. *Influence of Water in Electro-chemical Decomposition.* ¶ iii. *Theory of Electro-chemical Decomposition.*

Received June 18,—Read June 20, 1833.

§ 11. *On Electro-chemical Decomposition*.*

450. I HAVE in a recent series of these Researches (265.) proved (to my own satisfaction, at least,) the identity of electricities derived from different sources, and have especially dwelt upon the proofs of the sameness of those obtained by the use of the common electrical machine and the voltaic battery.

451. The great distinction of the electricities obtained from these two sources is the very high tension to which the small quantity obtained by aid of the machine may be raised, and the enormous quantity (371. 376.) in which that of comparatively low tension, supplied by the voltaic battery, may be procured; but as their actions, whether magnetical, chemical, or of any other nature, are essentially the same (360.), it appeared evident that we might reason from the former as to the manner of action of the latter; and it was, to me, a probable consequence, that the use of electricity of such intensity as that afforded by the machine, would, when applied to effect and elucidate electro-chemical decomposition, show some new conditions of that action, evolve new views of the internal arrangements and changes of the substances under decomposition, and perhaps give efficient powers over matter as yet undecomposed.

452. For the purpose of rendering the bearings of the different parts of this series of researches more distinct, I shall divide it into several heads.

¶ i. *New conditions of Electro-chemical Decomposition.*

453. The tension of machine electricity causes it, however

* Refer to the note after 1047, Series viii.—Dec. 1838.

small in quantity, to pass through any length of water, solutions, or other substances classing with these as conductors, as fast as it can be produced, and therefore, in relation to quantity, as fast as it could have passed through much shorter portions of the same conducting substance. With the voltaic battery the case is very different, and the passing current of electricity supplied by it suffers serious diminution in any substance, by considerable extension of its length, but especially in such bodies as those mentioned above.

454. I endeavoured to apply this facility of transmitting the current of electricity through any length of a conductor, to an investigation of the transfer of the elements in a decomposing body, in contrary directions, towards the poles. The general form of apparatus used in these experiments has been already described (312. 316.) ; and also a particular experiment (319.), in which, when a piece of litmus paper and a piece of turmeric paper were combined and moistened in solution of sulphate of soda, the point of the wire from the machine (representing the positive pole) put upon the litmus paper, and the receiving point from the discharging train (292. 316.), representing the negative pole, upon the turmeric paper, a very few turns of the machine sufficed to show the evolution of acid at the former, and alkali at the latter, exactly in the manner effected by a volta-electric current.

455. The pieces of litmus and turmeric paper were *now* placed each upon a separate plate of glass, and connected by an insulated string four feet long, moistened in the same solution of sulphate of soda ; the terminal decomposing wire points were placed upon the papers as before. On working the machine, the same evolution of acid and alkali appeared as in the former instance, and with equal readiness, notwithstanding that the places of their appearance were four feet apart from each other. Finally, a piece of string, seventy feet long, was used. It was insulated in the air by suspenders of silk, so that the electricity passed through its entire length : decomposition took place exactly, as in former cases, alkali and acid appearing at the two extremities in their proper places.

456. Experiments were then made both with sulphate of soda and iodide of potassium, to ascertain if any diminution of decomposing effect was produced by such great extension as

those just described of the moist conductor or body under decomposition; but whether the contact of the decomposing point connected with the discharging train was made with turmeric paper touching the prime conductor, or with other turmeric paper connected with it through the seventy feet of string, the spot of alkali for an equal number of turns of the machine had equal intensity of colour. The same results occurred at the other decomposing wire, whether the salt or the iodide were used; and it was fully proved that this great extension of the distance between the poles produced no effect whatever on the amount of decomposition, provided the same *quantity* of electricity were passed in both cases (377.).

457. The negative point of the discharging train, the turmeric paper, and the string were then removed; the positive point was left resting upon the litmus paper, and the latter touched by a piece of moistened string held in the hand. A few turns of the machine evolved acid at the positive point as freely as before.

458. The end of the moistened string, instead of being held in the hand, was suspended by glass in the air. On working the machine the electricity proceeded from the conductor through the wire point to the litmus paper, and thence away by the intervention of the string to the air, so that there was (as in the last experiment,) but one metallic pole; still acid was evolved there as freely as in any former case.

459. When any of these experiments were repeated with electricity from the negative conductor, corresponding effects were produced whether one or two decomposing wires were used. The results were always constant, considered in relation to the *direction* of the electric current.

460. These experiments were varied so as to include the action of only one metallic pole, but that not the pole connected with the machine. Turmeric paper was moistened in solution of sulphate of soda, placed upon glass, and connected with the discharging train (292.) by a decomposing wire (312.); a piece of wet string was hung from it, the lower extremity of which was brought opposite a point connected with the positive prime conductor of the machine. The machine was then worked for a few turns, and alkali immediately appeared at the point of the discharging train which rested on the turmeric paper.

Corresponding effects took place at the negative conductor of a machine.

461. These cases are abundantly sufficient to show that electro-chemical decomposition does not depend upon the simultaneous action of two metallic poles, since a single pole might be used, decomposition ensue, and one or other of the elements liberated, pass to the pole, according as it was positive or negative. In considering the course taken by, and the final arrangement of, the other element, I had little doubt that I should find it had reeled towards the other extremity, and that the air itself had acted as a pole, an expectation which was fully confirmed in the following manner.

462. A piece of turmeric paper, not more than 0.4 of an inch in length and 0.5 of an inch in width, was moistened with sulphate of soda and placed upon the edge of a glass plate opposite to, and about two inches from, a point connected with the discharging train (Plate IV. fig. 47.); a piece of tinfoil, resting upon the same glass plate, was connected with the machine, and also with the turmeric paper, by a decomposing wire *a* (312). The machine was then worked, the positive electricity passing into the turmeric paper at the point *p*, and out at the extremity *n*. After forty or fifty turns of the machine, the extremity *n* was examined, and the two points or angles found deeply coloured by the presence of free alkali (fig. 48.).

463. A similar piece of litmus paper, dipped in solution of sulphate of soda *n*, fig. 49, was now supported upon the end of the discharging train *a*, and its extremity brought opposite to a point *p*, connected with the conductor of the machine. After working the machine for a short time, acid was developed at both the corners towards the point, *i. e.* at both the corners receiving the electricities from the air. Every precaution was taken to prevent this acid from being formed by sparks or brushes passing through the air (322.); and these, with the accompanying general facts, are sufficient to show that the acid was really the result of electro-chemical decomposition (466.).

464. Then a long piece of turmeric paper, large at one end and pointed at the other, was moistened in the saline solution, and immediately connected with the conductor of the machine, so that its pointed extremity was opposite a point upon the

discharging train. When the machine was worked, alkali was evolved at that point; and even when the discharging train was removed, and the electricity left to be diffused and carried off altogether by the air, still alkali was evolved where the electricity left the turmeric paper.

465. Arrangements were then made in which no metallic communication with the decomposing matter was allowed, but both poles (if they might now be called by that name,) formed of air only. A piece of turmeric paper *a* fig. 50, and a piece of litmus paper *b*, were dipped in solution of sulphate of soda, put together so as to form one moist pointed conductor, and supported on wax between two needle points, one *p* connected by a wire with the conductor of the machine, and the other, *n*, with the discharging train. The interval in each case between the points was about half an inch: the positive point *p* was opposite the litmus paper; the negative point *n* opposite the turmeric. The machine was then worked for a time, upon which evidence of decomposition quickly appeared, for the point of the litmus *b* became reddened from acid evolved there, and the point of the turmeric *a* red from a similar and simultaneous evolution of alkali.

466. Upon turning the paper conductor round, so that the litmus point should now give off the positive electricity, and the turmeric point receive it, and working the machine for a short time, both the red spots disappeared, and as on continuing the action of the machine no red spot was re-formed at the litmus extremity, it proved that in the first instance (463.) the effect was not due to the action of brushes or mere electric discharges causing the formation of nitric acid from the air (322.).

467. If the combined litmus and turmeric paper in this experiment be considered as constituting a conductor independent of the machine or the discharging train, and the final places of the elements evolved be considered in relation to this conductor, then it will be found that the acid collects at the *negative* or receiving end or pole of the arrangement, and the alkali at the *positive* or delivering extremity.

468. Similar litmus and turmeric paper points were now placed upon glass plates, and connected by a string six feet long, both string and paper being moistened in solution of

sulphate of soda; a needle point connected with the machine was brought opposite the litmus paper point, and another needle point connected with the discharging train brought opposite the turmeric paper. On working the machine, acid appeared on the litmus, and alkali on the turmeric paper; but the latter was not so abundant as in former cases, for much of the electricity passed off from the string into the air, and diminished the quantity discharged at the turmeric point.

469. Finally, a series of four small compound conductors, consisting of litmus and turmeric paper (fig. 51.) moistened in solution of sulphate of soda, were supported on glass rods, in a line at a little distance from each other, between the points *p* and *n* of the machine and discharging train, so that the electricity might pass in succession through them, entering in at the litmus points *b, b*, and passing out at the turmeric points *a, a*. On working the machine carefully, so as to avoid sparks and brushes (322.), I soon obtained evidence of decomposition in each of the moist conductors, for all the litmus points exhibited free acid; and the turmeric points equally showed free alkali.

470. On using solutions of iodide of potassium, acetate of lead, &c., similar effects were obtained; but as they were all consistent with the results above described, I refrain from describing the appearances minutely.

471. These cases of electro-chemical decomposition are in their nature exactly of the same kind as those affected under ordinary circumstances by the voltaic battery, notwithstanding the great differences as to the presence or absence, or at least as to the nature of the parts usually called poles; and also of the final situation of the elements eliminated at the electrified boundary surfaces (467.). They indicate at once an internal action of the parts suffering decomposition, and appear to show that the power which is effectual in separating the elements is exerted there, and not at the poles. But I shall defer the consideration of this point for a short time (493. 518.), that I may previously consider another supposed condition of electro-chemical decomposition*.

* I find (since making and describing these results,) from a note to Sir Humphry Davy's paper in the Philosophical Transactions, 1807, p. 31, that that philosopher, in repeating Wollaston's experiment of the decomposition of water by common electricity (327. 330.) used an arrangement somewhat like

¶ ii. *Influence of Water in Electro-chemical Decomposition.*

472. It is the opinion of several philosophers, that the presence of water is essential in electro-chemical decomposition, and also for the evolution of electricity in the voltaic battery itself. As the decomposing cell is merely one of the cells of the battery, into which particular substances are introduced for the purpose of experiment, it is probable that what is an essential condition in the one case is more or less so in the other. The opinion, therefore, that water is necessary to decomposition, may have been founded on the statement made by Sir Humphry Davy, that "there are no fluids known, except such as contain water, which are capable of being made the medium of connexion between the metals or metal of the voltaic apparatus*:" and again, "when any substance rendered fluid by heat, consisting of *water*, oxygen, and inflammable or metallic matter, is exposed to those wires, similar phenomena (of decomposition) occur†."

473. This opinion has, I think, been shown by other philosophers not to be accurate, though I do not know where to refer for a contradiction of it. Sir Humphry Davy himself said in 1801 ‡, that dry nitre, caustic potash and soda are conductors of galvanism when rendered fluid by a high degree of heat; but he must have considered them, or the nitre at least, as not suffering decomposition, for the statements above were made by him eleven years subsequently. In 1826 he also pointed out, that bodies not containing water, as *fused litharge* and *chlorate of potassa*, were sufficient to form, with platina and zinc, powerful electromotive circles §; but he is here speaking of the *production* of electricity in the pile, and not of its effects when evolved; nor do his words at all imply that any correction of his former distinct statements relative to *decomposition* was required.

474. I may refer to the last series of these Experimental some of those I have described. He immersed a guarded platina point connected with the machine in distilled water, and dissipated the electricity from the water into the air by moistened filaments of cotton. In this way he states that he obtained oxygen and hydrogen *separately* from each other. This experiment, had I known of it, ought to have been quoted in an earlier series of these Researches (342.); but it does not remove any of the objections I have made to the use of Wollaston's apparatus as a test of true chemical action (331.).

* Elements of Chemical Philosophy, p. 169, &c.

† Ibid. pp. 144, 145.

‡ Journal of the Royal Institution, 1802, p. 53.

§ Philosophical Transactions, 1826, p. 406.

Researches (380. 402.) as setting the matter at rest, by proving that there are hundreds of bodies equally influential with water in this respect; that amongst binary compounds, oxides, chlorides, iodides, and even sulphurets (402.) were effective; and that amongst more complicated compounds, cyanides and salts of equal efficacy, occurred in great numbers (402.).

475. Water, therefore, is in this respect merely one of a very numerous class of substances, instead of being the *only one* and *essential*; and it is of that class one of the *worst* as to its capability of facilitating conduction and suffering decomposition. The reasons why it obtained for a time an exclusive character which it so little deserved are evident, and consist, in the general necessity of a fluid condition (394.); in its being the *only one* of this class of bodies existing in the fluid state at common temperatures; its abundant supply as the great natural solvent; and its constant use in that character in philosophical investigations, because of its having a smaller interfering, injurious, or complicating action upon the bodies, either dissolved or evolved, than any other substance.

476. The analogy of the decomposing or experimental cell to the other cells of the voltaic battery, renders it nearly certain that any of those substances which are decomposable when fluid, as described in my last paper (402.), would, if they could be introduced between the metallic plates of the pile be equally effectual with water if not more so. Sir Humphry Davy found that litharge and chlorate of potassa were thus effectual*. I have constructed various voltaic arrangements, and found the above conclusion to hold good. When any of the following substances in a fused state were interposed between copper and platina, voltaic action more or less powerful was produced. Nitre; chlorate of potassa; carbonate of potassa; sulphate of soda; chloride of lead, of sodium, of bismuth, of calcium; iodide of lead; oxide of bismuth; oxide of lead: the electric current was in the same direction as if acids had acted upon the metals. When any of the same substances, or phosphate of soda, were made to act on platina and iron, still more powerful voltaic combinations of the same kind were produced. When either nitrate of silver or chloride of silver was the fluid substance interposed, there was voltaic action, but the electric current was in the reverse direction.

* Philosophical Transactions, 1826, p. 406.

¶ iii. *Theory of Electro-chemical Decomposition.*

477. The extreme beauty and value of electro-chemical decompositions have given to that power which the voltaic pile possesses of causing their occurrence an interest surpassing that of any other of its properties; for the power is not only intimately connected with the continuance, if not with the production, of the electrical phenomena, but it has furnished us with the most beautiful demonstrations of the nature of many compound bodies; has in the hands of Beequerel been employed in compounding substances; has given us several new combinations, and sustains us with the hope that when thoroughly understood it will produce many more.

478. What may be considered as the general facts of electro-chemical decomposition are agreed to by nearly all who have written on the subject. They consist in the separation of the decomposable substance acted upon into its proximate or sometimes ultimate principles, whenever both poles of the pile are in contact with that substance in a proper condition; in the evolution of these principles at distant points, *i. e.* at the poles of the pile, where they are either finally set free or enter into union with the substance of the poles; and in the constant determination of the evolved elements or principles to particular poles according to certain well ascertained laws.

479. But the views of men of science vary much as to the nature of the action by which these effects are produced; and as it is certain that we shall be better able to apply the power when we really understand the manner in which it operates, this difference of opinion is a strong inducement to further inquiry. I have been led to hope that the following investigations might be considered, not as an increase of that which is doubtful, but a real addition to this branch of knowledge.

480. It will be needful that I briefly state the views of electro-chemical decomposition already put forth, that their present contradictory and unsatisfactory state may be seen before I give that which seems to me more accurately to agree with facts; and I have ventured to discuss them freely, trusting that I should give no offence to their high-minded authors; for I felt convinced that if I were right, they would be pleased that their views should serve as stepping-stones for the advance of

science; and that if I were wrong, they would excuse the zeal which misled me, since it was exerted for the service of that great cause whose prosperity and progress they have desired.

481. Grotthuss, in the year 1805, wrote expressly on the decomposition of liquids by voltaic electricity*. He considers the pile as an electric magnet, *i. e.* as an attractive and repulsive agent; the poles having *attractive* and *repelling* powers. The pole from whence resinous electricity issues attracts hydrogen and repels oxygen, whilst that from which vitreous electricity proceeds attracts oxygen and repels hydrogen; so that each of the elements of a particle of water, for instance, is subject to an attractive and a repulsive force, acting in contrary directions, the centres of action of which are reciprocally opposed. The action of each force in relation to a molecule of water situated in the course of the electric current is in the inverse ratio of the square of the distance at which it is exerted, thus giving (it is stated) for such a molecule a *constant force* †. He explains the appearance of the elements at a distance from each other by referring to a succession of decompositions and recompositions occurring amongst the intervening particles ‡, and he thinks it probable that those which are about to separate at the poles unite to the two electricities there, and in consequence become gases §.

482. Sir Humphry Davy's celebrated Bakerian Lecture on some chemical agencies of electricity was read in November 1806, and is almost entirely occupied in the consideration of *electro-chemical decompositions*. The facts are of the utmost value, and, with the general points established, are universally known. The *mode of action* by which the effects take place is stated very generally, so generally, indeed, that probably a dozen precise schemes of electro-chemical action might be drawn up, differing essentially from each other, yet all agreeing with the statement there given.

483. When Sir Humphry Davy uses more particular expressions, he seems to refer the decomposing effects to the attractions of the poles. This is the case in the "general ex-

* Annales de Chimie, 1806, tom. lviii. p. 64.

† Ibid. pp. 66, 67, also tom. lxiii. p. 20.

‡ Ibid. tom. lviii. p. 68, tom. lxiii. p. 20.

§ Ibid. tom. lxiii. p. 34.

pression of facts” given at pp. 28 and 29 of the Philosophical Transactions for 1807, also at p. 30. Again at p. 161 of the Elements of Chemical Philosophy, he speaks of the great attracting powers of the surfaces of the poles. He mentions the probability of a succession of decompositions and recompositions throughout the fluid,—agreeing in that respect with Grotthuss* ; and supposes that the attractive and repellent agencies may be communicated from the metallic surfaces throughout the whole of the menstruum †, being communicated from *one particle to another particle of the same kind* ‡, and diminishing in strength from the place of the poles to the middle point, which is necessarily neutral §. In reference to this diminution of power at increased distances from the poles, he states that in a circuit of ten inches of water, solution of sulphate of potassa placed four inches from the positive pole, did not decompose ; whereas when only two inches from that pole, it did render up its elements ||.

484. When in 1826 Sir Humphry Davy wrote again on this subject, he stated that he found nothing to alter in the fundamental theory laid down in the original communication ¶, and uses the terms attraction and repulsion apparently in the same sense as before **.

485. Messrs. Riffault and Chompré experimented on this subject in 1807. They came to the conclusion that the voltaic current caused decompositions throughout its whole course in the humid conductor, not merely as preliminary to the recompositions spoken of by Grotthuss and Davy, but producing final separation of the elements in the *course* of the current, and elsewhere than at the poles. They considered the *negative* current as collecting and carrying the acids, &c., to the *positive* pole, and the *positive* current as doing the same duty with the bases, and collecting them at the *negative* pole. They likewise consider the currents as *more powerful* the nearer they are to their respective poles, and state that the positive current is *superior* in power to the negative current ††.

486. M. Biot is very cautious in expressing an opinion as to

* Philosophical Transactions, 1807, pp. 29, 30.

† Ibid. p. 39.

‡ Ibid. p. 29.

§ Ibid. p. 42.

|| Ibid. p. 42.

¶ Ibid. 1826, p. 383.

** Ibid. pp. 389, 407, 415.

†† Annales de Chimie, 1807, tom. lxiii. p. 83, &c.

the cause of the separation of the elements of a compound body*. But as far as the effects can be understood, he refers them to the opposite electrical states of the portions of the decomposing substance in the neighbourhood of the two poles. The fluid is most positive at the positive pole; that state gradually diminishes to the middle distance, where the fluid is neutral or not electrical; but from thence to the negative pole it becomes more and more negative †. When a particle in salt is decomposed at the negative pole, the acid particle is considered as acquiring a negative electrical state from the pole, stronger than that of the surrounding *undecomposed* particles, and is therefore repelled from amongst them, and from out of that portion of the liquid towards the positive pole, towards which also it is drawn by the attraction of the pole itself and the particles of positive *undecomposed* fluid around it ‡.

487. M. Biot does not appear to admit the successive decompositions and recompositions spoken of by Grotthuss, Davy, &c. &c.; but seems to consider the substance whilst in transit as combined with, or rather attached to, the electricity for the time§, and though it communicates this electricity to the surrounding undecomposed matter with which it is in contact, yet it retains during the transit a little superiority with respect to that kind which it first received from the pole, and is, by virtue of that difference, carried forward through the fluid to the opposite pole||.

488. This theory implies that decomposition takes place at both poles upon distinct portions of fluid, and not at all in the intervening parts. The latter serve merely as imperfect conductors, which, assuming an electric state, urge particles electrified more highly at the poles through them in opposite directions, by virtue of a series of ordinary electrical attractions and repulsions¶.

489. M. A. de la Rive investigated this subject particularly, and published a paper on it in 1825**. He thinks those who have referred the phenomena to the attractive powers of the poles, rather express the general fact than give any explanation

* Précis Elémentaire de Physique, 3^{me} édition, 1824, tom. i. p. 641.

† Ibid. p. 637.

‡ Ibid. pp. 641, 642.

§ Ibid. p. 636.

|| Ibid. p. 642.

¶ Ibid. pp. 633, 642.

** Annales de Chimie, tom. xxviii. p. 190.

of it. He considers the results as due to an actual combination of the elements, or rather of half of them, with the electricities passing from the poles in consequence of a kind of play of affinities between the matter and electricity*. The current from the positive pole combining with the hydrogen, or the bases it finds there, leaves the oxygen and acids at liberty, but carries the substances it is united with across to the negative pole, where, because of the peculiar character of the metal as a conductor†, it is separated from them, entering the metal and leaving the hydrogen or bases upon its surface. In the same manner the electricity from the negative pole sets the hydrogen and bases which it finds there, free, but combines with the oxygen and acids, carries them across to the positive pole, and there deposits them‡. In this respect M. de la Rive's hypothesis accords in part with that of MM. Riffault and Chompré (485.).

490. M. de la Rive considers the portions of matter which are decomposed to be those contiguous to *both* poles§. He does not admit with others the successive decompositions and recompositions in the whole course of the electricity through the humid conductor||, but thinks the middle parts are in themselves unaltered, or at least serve only to conduct the two contrary currents of electricity and matter which set off from the opposite poles¶. The decomposition, therefore, of a particle of water, or a particle of salt, may take place at either pole, and when once effected, it is final for the time, no recombination taking place, except the momentary union of the transferred particle with the electricity be so considered.

491. The latest communication that I am aware of on the subject is by M. Hachette: its date is October 1832**. It is incidental to the description of the decomposition of water by the magneto-electric currents (346.). One of the results of the experiment is, that "it is not necessary, as has been supposed, that for the chemical decomposition of water, the action of the two electricities, positive and negative, should be simultaneous."

492. It is more than probable that many other views of electro-chemical decomposition may have been published, and perhaps amongst them some which, differing from those above,

* Annales de Chimie, tom. xxviii. pp. 200, 202.

† Ibid. p. 202.

‡ Ibid. p. 201.

§ Ibid. pp. 197, 198.

|| Ibid. pp. 192, 199.

¶ Ibid. p. 200.

** Ibid. tom. li. p. 73.

might, even in my own opinion, were I acquainted with them, obviate the necessity for the publication of my views. If such be the case, I have to regret my ignorance of them, and apologize to the authors.

493. That electro-chemical decomposition does not depend upon any direct attraction and repulsion of the poles (meaning thereby the metallic terminations either of the voltaic battery, or ordinary electrical machine arrangements (312),) upon the elements in contact with or near to them, appeared very evident from the experiments made in air (462, 465, &c.), when the substances evolved did not collect about any poles, but, in obedience to the direction of the current, were evolved, and I would say ejected, at the extremities of the decomposing substance. But notwithstanding the extreme dissimilarity in the character of air and metals, and the almost total difference existing between them as to their mode of conducting electricity, and becoming charged with it, it might perhaps still be contended, although quite hypothetically, that the bounding portions of air were now the surfaces or places of attraction, as the metals had been supposed to be before. In illustration of this and other points, I endeavoured to devise an arrangement by which I could decompose a body against a surface of water, as well as against air or metal, and succeeded in doing so unexceptionably in the following manner. As the experiment for very natural reasons requires many precautions, to be successful, and will be referred to hereafter in illustration of the views I shall venture to give, I must describe it minutely.

494. A glass basin (fig. 52.), four inches in diameter and four inches deep, had a division of mica *a*, fixed across the upper part so as to descend one inch and a half below the edge, and be perfectly water-tight at the sides: a plate of platina *b*, three inches wide, was put into the basin on one side of the division *a*, and retained there by a glass block below, so that any gas produced by it in a future stage of the experiment should not ascend beyond the mica, and cause currents in the liquid on that side. A strong solution of sulphate of magnesia was carefully poured without splashing into the basin, until it rose a little above the lower edge of the mica division *a*, great care being taken that the glass or mica on the unoccupied or *c* side of the division in the figure, should not be moistened by agita-

tion of the solution above the level to which it rose. A thin piece of clean cork, well wetted in distilled water, was then carefully and lightly placed on the solution at the *c* side, and distilled water poured gently on to it until a stratum the eighth of an inch in thickness appeared over the sulphate of magnesia; all was then left for a few minutes, that any solution adhering to the cork might sink away from it, or be removed by the water on which it now floated; and then more distilled water was added in a similar manner, until it reached nearly to the top of the glass. In this way solution of the sulphate occupied the lower part of the glass, and also the upper on the right hand side of the mica; but on the left hand side of the division a stratum of water from *c* to *d*, one inch and a half in depth, reposed upon it, the two presenting, when looked through horizontally, a comparatively definite plane of contact. A second platina pole *e*, was arranged so as to be just under the surface of the water, in a position nearly horizontal, a little inclination being given to it, that gas evolved during decomposition might escape: the part immersed was three inches and a half long by one inch wide, and about seven eighths of an inch of water intervened between it and the solution of sulphate of magnesia.

495. The latter pole *e* was now connected with the negative end of a voltaic battery, of forty pairs of plates four inches square, whilst the former pole *b* was connected with the positive end. There was action and gas evolved at both poles; but from the intervention of the pure water, the decomposition was very feeble compared to what the battery would have effected in a uniform solution. After a little while (less than a minute), magnesia also appeared at the negative side: *it did not make its appearance at the negative metallic pole, but in the water*, at the plane where the solution and the water met; and on looking at it horizontally, it could be there perceived lying in the water upon the solution, not rising more than the fourth of an inch above the latter, whilst the water between it and the negative pole was perfectly clear. On continuing the action, the bubbles of hydrogen rising upwards from the negative pole impressed a circulatory movement on the stratum of water, upwards in the middle, and downwards at the side, which gradually gave an ascending form to the cloud of magnesia in the part just under the pole, having an appearance

as if it were there attracted to it; but this was altogether an effect of the currents, and did not occur until long after the phenomena looked for were satisfactorily ascertained.

496. After a little while the voltaic communication was broken, and the platina poles removed with as little agitation as possible from the water and solution, for the purpose of examining the liquid adhering to them. The pole *e*, when touched by turmeric paper, gave no trace of alkali, nor could anything but pure water be found upon it. The pole *b*, though drawn through a much greater depth and quantity of fluid, was found so acid as to give abundant evidence to litmus paper, the tongue, and other tests. Hence there had been no interference of alkaline salts in any way, undergoing first decomposition, and then causing the separation of the magnesia at a distance from the pole by mere chemical agencies. This experiment was repeated again and again, and always successfully.

497. As, therefore, the substances evolved in cases of electrochemical decomposition may be made to appear against air (465. 469.),—which, according to common language, is not a conductor, nor is decomposed, or against water (495.), which is a conductor, and can be decomposed,—as well as against the metal poles, which are excellent conductors, but undecomposable, there appears but little reason to consider the phenomena generally, as due to the *attraction* or attractive powers of the latter, when used in the ordinary way, since similar attractions can hardly be imagined in the former instances.

498. It may be said that the surfaces of air or of water in these cases become the poles, and exert attractive powers; but what proof is there of that, except the fact that the matters evolved collect there, which is the point to be explained, and cannot be justly quoted as its own explanation? Or it may be said, that any section of the humid conductor, as that in the present case, where the solution and the water meet, may be considered as representing the pole. But such does not appear to me to be the view of those who have written on the subject, certainly not of some of them, and is inconsistent with the supposed laws which they have assumed, as governing the diminution of power at increased distances from the poles.

499. Grotthuss, for instance, describes the poles as centres of attractive and repulsive forces (481.), these forces varying

inversely as the squares of the distances, and says, therefore, that a particle placed anywhere between the poles will be acted upon by a constant force. But the compound force, resulting from such a combination as he supposes, would be anything but a constant force; it would evidently be a force greatest at the poles, and diminishing to the middle distance. Grotthuss is right, however, *in the fact*, according to my experiments (502. 505.), that the particles are acted upon by equal force everywhere in the circuit, when the conditions of the experiment are the simplest possible; but the fact is against his theory, and is also, I think, against all theories that place the decomposing effect in the attractive power of the poles.

500. Sir Humphry Davy, who also speaks of the *diminution* of power with increase of distance from the poles* (483.), supposes, that when both poles are acting on substances to decompose them, still the power of decomposition *diminishes* to the middle distance. In this statement of fact he is opposed to Grotthuss, and quotes an experiment in which sulphate of potassa, placed at different distances from the poles in a humid conductor of constant length, decomposed when near the pole, but not when at a distance. Such a consequence would necessarily result theoretically from considering the poles as centres of attraction and repulsion; but I have not found the statement borne out by other experiments (505.); and in the one quoted by him the effect was doubtless due to some of the many interfering causes of variation which attend such investigations.

501. A glass vessel had a platina plate fixed perpendicularly across it, so as to divide it into two cells: a head of mica was fixed over it, so as to collect the gas it might evolve during experiments; then each cell, and the space beneath the mica, was filled with dilute sulphuric acid. Two poles were provided, consisting each of a platina wire terminated by a plate of the same metal; each was fixed into a tube passing through its upper end by an air-tight joint, that it might be moveable, and yet that the gas evolved at it might be collected. The tubes were filled with the acid, and one immersed in each cell. Each platina pole was equal in surface to one side of the dividing plate in the middle glass vessel, and the whole might be con-

* Philosophical Transactions, 1807, p. 42.

sidered as an arrangement between the poles of the battery of a humid decomposable conductor divided in the middle by the interposed platina diaphragm. It was easy, when required, to draw one of the poles further up the tube, and then the platina diaphragm was no longer in the middle of the humid conductor. But whether it was thus arranged at the middle, or towards one side, it always evolved a quantity of oxygen and hydrogen equal to that evolved by the extreme plates*.

502. If the wires of a galvanometer be terminated by plates, and these be immersed in dilute acid, contained in a regularly formed rectangular glass trough, connected at each end with a voltaic battery by poles equal to the section of the fluid, a part of the electricity will pass through the instrument and cause a certain deflection. And if the plates are always retained at the *same distance from each other* and from the sides of the trough, are always parallel to each other, and uniformly placed relative to the fluid, then, whether they are immersed near the middle of the decomposing solution, or at one end, still the instrument will indicate the same deflection, and consequently the same electric influence.

503. It is very evident, that when the width of the decomposing conductor varies, as is always the case when mere wires or plates, as poles, are dipped into or are surrounded by solution, no constant expression can be given as to the action upon a single particle placed in the course of the current, nor any conclusion of use, relative to the supposed attractive or repulsive force of the poles, be drawn. The force will vary as the distance from the pole varies; as the particle is directly between the poles, or more or less on one side; and even as it is nearer to or further from the sides of the containing vessels, or as the shape of the vessel itself varies; and, in fact by making variations in the form of the arrangement, the force upon any single particle may be made to increase, or diminish, or remain constant, whilst the distance between the particle and the pole shall remain the same; or the force may be made to increase, or diminish, or remain constant, either as the distance increases or as it diminishes.

* There are certain precautions, in this and such experiments, which can only be understood and guarded against by a knowledge of the phenomena to be described in the first part of the Sixth Series of these Researches.

504. From numerous experiments, I am led to believe the following general expression to be correct; but I purpose examining it much further, and would therefore wish not to be considered at present as pledged to its accuracy. *The sum of chemical decomposition is constant* for any section taken across a decomposing conductor, uniform in its nature, at whatever distance the poles may be from each other or from the section; or however that section may intersect the currents, whether directly across them, or so oblique as to reach almost from pole to pole, or whether it be plain, or curved, or irregular in the utmost degree; provided the current of electricity be retained constant in quantity (377.), and that the section passes through every part of the current through the decomposing conductor.

505. I have reason to believe that the statement might be made still more general, and expressed thus: *That for a constant quantity of electricity, whatever the decomposing conductor may be, whether water, saline solutions, acids, fused bodies, &c., the amount of electro-chemical action is also a constant quantity, i. e. would always be equivalent to a standard chemical effect founded upon ordinary chemical affinity.* I have this investigation in hand, with several others, and shall be prepared to give it in the next series but one of these Researches.

506. Many other arguments might be adduced against the hypotheses of the attraction of the poles being the cause of electro-chemical decomposition; but I would rather pass on to the view I have thought more consistent with facts, with this single remark; that if decomposition by the voltaic battery depended upon the attraction of the poles, or the parts about them, being stronger than the mutual attraction of the particles separated, it would follow that the weakest *electrical* attraction was stronger than, if not the strongest, yet very strong *chemical* attraction, namely, such as exists between oxygen and hydrogen, potassium and oxygen, chloride and sodium, acid and alkali, &c., a consequence which, although perhaps not impossible, seems in the present state of the subject very unlikely.

507. The view which M. De la Rive has taken (489.), and also MM. Riffault and Chompré (485.), of the manner in which electro-chemical decomposition is effected, is very different to that already considered, and is not affected by either the argu-

ments or facts urged against the latter. Considering it as stated by the former philosopher, it appears to me to be incompetent to account for the experiments of decomposition against surfaces of air (462. 469.) and water (495.), which I have described; for if the physical differences between metals and humid conductors, which M. de la Rive supposes to account for the transmission of the compound of matter and electricity in the latter, and the transmission of the electricity only with the rejection of the matter in the former, be allowed for a moment, still the analogy of air to metal is, electrically considered, so small, that instead of the former replacing the latter (462.), an effect the very reverse might have been expected. Or if even that were allowed, the experiment with water (495.) at once sets the matter at rest, the decomposing pole being now of a substance which is admitted as competent to transmit the assumed compound of electricity and matter.

508. With regard to the views of MM. Riffault and Chompré (485.), the occurrence of decomposition alone in the *course* of the current is so contrary to the well-known effects obtained in the forms of experiment adopted up to this time, that it must be proved before the hypothesis depending on it need be considered.

509. The consideration of the various theories of electro-chemical decomposition, whilst it has made me diffident, has also give me confidence to add another to the number; for it is because the one I have to propose appears, after the most attentive consideration, to explain and agree with the immense collection of facts belonging to this branch of science, and to remain uncontradicted by, or unopposed to, any of them, that I have been encouraged to give it.

510. Electro-chemical decomposition is well-known to depend essentially upon the *current* of electricity. I have shown that in certain cases (375.) the decomposition is proportionate to the quantity of electricity passing, whatever may be its intensity or its source, and that the same is probably true for all cases (377.), even when the utmost generality is taken on the one hand, and great precision of expression on the other (505.).

511. In speaking of the current, I find myself obliged to be still more particular than on a former occasion (283.), in consequence of the variety of views taken by philosophers, all agree-

ing in the effect of the current itself. Some philosophers, with Franklin, assume but one electric fluid; and such must agree together in the general uniformity and character of the electric current. Others assume two electric fluids; and here singular differences have arisen.

512. MM. Riffault and Chompré, for instance, consider the positive and negative currents each as causing decomposition, and state that the positive current is *more powerful* than the negative current*, the nitrate of soda being, under similar circumstances, decomposed by the former, but not by the latter.

513. M. Hachette states† that “it is not necessary, as has been believed, that the action of the two electricities, positive and negative, should be simultaneous for the decomposition of water.” The passage implying, if I have caught the meaning aright, that one electricity can be obtained, and can be applied in effecting decompositions, independent of the other.

514. The view of M. de la Rive to a certain extent agrees with that of M. Hachette, for he considers that the two electricities decompose separate portions of water (490.)‡. In one passage he speaks of the two electricities as two influences, wishing perhaps to avoid offering a decided opinion upon the independent existence of electric fluids; but as these influences are considered as combining with the elements set free as by a species of chemical affinity, and for the time entirely masking their character, great vagueness of idea is thus introduced, inasmuch as such a species of combination can only be conceived to take place between things having independent existences. The two elementary electric currents, moving in opposite directions, from pole to pole, constitute the ordinary *voltaic current*.

515. M. Grotthuss is inclined to believe that the elements of water, when about to separate at the poles, combine with the electricities, and so become gases. M. de la Rive's view is the exact reverse of this: whilst passing through the fluid, they are, according to him, compounds with the electricities; when evolved at the poles, they are de-electrified.

516. I have sought amongst the various experiments quoted

* *Annales de Chimie*, 1807, tom. lxxiii. p. 84. † *Ibid.* 1832, tom. li. p. 73.

‡ *Ibid.* 1825, tom. xxviii. pp. 197, 201.

in support of these views, or connected with electro-chemical decompositions or electric currents, for any which might be considered as sustaining the theory of two electricities rather than that of one, but have not been able to perceive a single fact which could be brought forward for such a purpose: or, admitting the hypothesis of two electricities, much less have I been able to perceive the slightest grounds for believing that one electricity in a current can be more powerful than the other, or that it can be present without the other, or that one can be varied or in the slightest degree affected; without a corresponding variation in the other*. If, upon the supposition of two electricities, a current of one can be obtained without the other, or the current of one be exalted or diminished more than the other, we might surely expect some variation either of the chemical or magnetical effects, or of both; but no such variations have been observed. If a current be so directed that it may act chemically in one part of its course, and magnetically in another, the two actions are always found to take place together. A current has not, to my knowledge, been produced which could act chemically and not magnetically, nor any which can act on the magnet, and not *at the same time* chemically †.

517. *Judging from facts only*, there is not as yet the slightest reason for considering the influence which is present in what we call the electric current,—whether in metals or fused bodies or humid conductors, or even in air, flame, and rarefied elastic media,—as a compound or complicated influence. It has never been resolved into simpler or elementary influences, and may perhaps best be conceived of as *an axis of power having contrary forces, exactly equal in amount, in contrary directions*.

518. Passing to the consideration of electro-chemical decomposition, it appears to me that the effect is produced by an *internal corpuscular action*, exerted according to the direction of the electric current, and that it is due to a force either *super-added to*, or *giving direction to the ordinary chemical affinity* of the bodies present. The body under decomposition may be

* See now in relation to this subject, 1627—1645.—Dec. 1838.

† Thermo-electric currents are of course no exception, because when they fail to act chemically they also fail to be currents.

considered as a mass of acting partieles, all those which are included in the course of the electric current contributing to the final effect; and it is because the ordinary chemical affinity is relieved, weakened, or partly neutralized by the influence of the electric current in one direction parallel to the course of the latter, and strengthened or added to in the opposite direction, that the combining partieles have a tendency to pass in opposite courses.

519. In this view the effect is considered as *essentially dependent* upon the *mutual chemical affinity* of the partieles of opposite kinds. Partieles *a a*, fig. 53, could not be transferred or travel from one pole N towards the other P, unless they found partieles of the opposite kind *b b*, ready to pass in the contrary direction: for it is by virtue of their increased affinity for those partieles, combined with their diminished affinity for such as are behind them in their course, that they are urged forward: and when any one partiele *a*, fig. 54, arrives at the pole, it is excluded or set free, because the partiele *b* of the opposite kind, with which it was the moment before in combination, has, under the superinducing influence of the current, a greater attraction for the partiele *a'*, which is before it in its course, than for the partiele *a*, towards which its affinity has been weakened.

520. As far as regards any single compound partiele, the case may be considered as analogous to one of ordinary decomposition, for in fig. 54, *a* may be conceived to be expelled from the compound *a b* by the superior attraction of *a'* for *b*, that superior attraction belonging to it in consequence of the relative position of *a' b* and *a* to the direction of the axis of electric power (517.) superinduced by the current. But as all the compound partieles in the course of the current, except those actually in contact with the poles, act conjointly, and consist of elementary partieles, which, whilst they are in one direction expelling, are in the other being expelled, the case becomes more complicated, but not more difficult of comprehension.

521. It is not here assumed that the acting partieles must be in a right line between the poles. The lines of action which may be supposed to represent the electric currents passing through a decomposing liquid, have in many experiments very irregular forms; and even in the simplest case of two wires or points immersed as poles in a drop or larger single portion of

fluid, these lines must diverge rapidly from the poles; and the direction in which the chemical affinity between particles is most powerfully modified (519. 520.) will vary with the direction of these lines, according constantly with them. But even in reference to these lines or currents, it is not supposed that the particles which mutually affect each other must of necessity be parallel to them, but only that they shall accord generally with their direction. Two particles, placed in a line perpendicular to the electric current passing in any particular place, are not supposed to have their ordinary chemical relations towards each other affected; but as the line joining them is inclined one way to the current their mutual affinity is increased; as it is inclined in the other direction it is diminished; and the effect is a maximum, when that line is parallel to the current*.

522. That the actions, of whatever kind they may be, take place frequently in oblique directions is evident from the circumstance of those particles being included which in numerous cases are not in a line between the poles. Thus, when wires are used as poles in a glass of solution, the decompositions and recompositions occur to the right or left of the direct line between the poles, and indeed in every part to which the currents extend, as is proved by many experiments, and must therefore often occur between particles obliquely placed as respects the current itself; and when a metallic vessel containing the solution is made one pole, whilst a mere point or wire is used for the other, the decompositions and recompositions must frequently be still more oblique to the course of the currents.

523. The theory which I have ventured to put forth (almost) requires an admission, that in a compound body capable of electro-chemical decomposition the elementary particles have a mutual relation to, and influence upon each other, extending beyond those with which they are immediately combined. Thus in water, a particle of hydrogen in combination with oxygen is considered as not altogether indifferent to other particles of oxygen, although they are combined with other particles of hydrogen; but to have an affinity or attraction towards them, which, though it does not at all approach in force, under ordinary circumstances, to that by which it is combined with its own particle, can, under the electric influence, exerted in a defi-

* In reference to this subject see now electrolytic induction and discharge, Series XII. ¶ viii. 1343—1351, &c.—Dec. 1838.

nite direction, be made even to surpass it. This general relation of particles already in combination to other particles with which they are not combined, is sufficiently distinct in numerous results of a purely chemical character; especially in those where partial decompositions only take place, and in Berthollet's experiments on the effects of quantity upon affinity: and it probably has a direct relation to, and connexion with, attraction of aggregation, both in solids and fluids. It is a remarkable circumstance, that in gases and vapours, where the attraction of aggregation ceases, there likewise the decomposing powers of electricity apparently cease, and there also the chemical action of quantity is no longer evident. It seems not unlikely, that the inability to suffer decomposition in these cases may be dependent upon the absence of that mutual attractive relation of the particles which is the cause of aggregation.

524. I hope I have now distinctly stated, although in general terms, the view I entertain of the cause of electro-chemical decomposition, *as far as that cause can at present be traced and understood*. I conceive the effects to arise from forces which are *internal*, relative to the matter under decomposition—and not *external*, as they might be considered, if directly dependent upon the poles. I suppose that the effects are due to a modification, by the electric current, of the chemical affinity of the particles through or by which that current is passing, giving them the power of acting more forcibly in one direction than in another, and consequently making them travel by a series of successive decompositions and recompositions in opposite directions, and finally causing their expulsion or exclusion at the boundaries of the body under decomposition, in the direction of the current, *and that* in larger or smaller quantities, according as the current is more or less powerful (377.). I think, therefore, it would be more philosophical, and more directly expressive of the facts, to speak of such a body, in relation to the current passing through it, rather than to the poles, as they are usually called, in contact with it; and say that whilst under decomposition, oxygen, chlorine, iodine, acids, &c., are rendered at its negative extremity, and combustibles, metals, alkalis, bases, &c., at its positive extremity (467.). I do not believe that a substance can be transferred in the electric current beyond the point where it ceases to find particles with which it can combine; and I may refer to the experiments made in air

(465.), and in water (495.), already quoted, for facts illustrating these views in the first instance; to which I will now add others.

525. In order to show the dependenc of the decomposition and transfer of elements upon the chemical affinity of the substances present, experiments were made upon sulphuric acid in the following manner. Dilute sulphuric acid was prepared: its specific gravity was 1021.2. A solution of sulphate of soda was also prepared, of such strength that a measure of it contained exactly as much sulphuric acid as an equal measure of the diluted acid just referred to. A solution of pure soda, and another of pure ammonia, were likewise prepared, of such strengths that a measure of either should be exactly neutralized by a measure of the prepared sulphuric acid.

526. Four glass cups were then arranged, as in fig. 55; seventeen measures of the free sulphuric acid (525.) were put into each of the vessels *a* and *b*, and seventeen measures of the solution of sulphate of soda into each of the vessels A and B. Asbestos, which had been well washed in acid, acted upon by the voltaic pile, well washed in water, and dried by pressure, was used to connect *a* with *b* and A with B, the portions being as equal as they could be made in quantity, and cut as short as was consistent with their performing the part of effectual communications. *b* and A were connected by two platina plates or poles soldered to the extremities of one wire, and the cups *a* and B were by similar platina plates connected with a voltaic battery of forty pairs of plates four inches square, that in *a* being connected with the negative, and that in B with the positive pole. The battery, which was not powerfully charged, was retained in communication above half an hour. In this manner it was certain that the same electric current had passed through *a b* and A B, and that in each instance the same quantity and strength of acid had been submitted to its action, but in one case merely dissolved in water, and in the other dissolved and also combined with an alkali.

527. On breaking the connexion with the battery, the portions of asbestos were lifted out, and the drops hanging at the ends allowed to fall each into its respective vessel. The acids in *a* and *b* were then first compared, for which purpose two evaporating dishes were balanced, and the acid from *a* put into one, and that from *b* into the other; but as one was a little heavier than the other, a small drop was transferred from the

heavier to the lighter, and the two rendered equal in weight. Being neutralized by the addition of the soda solution (525.), that from *a*, or the negative vessel, required 15 parts of the soda solution, and that from *b*, or the positive vessel, required 16·3 parts. That the sum of these is not 34 parts is principally due to the acid removed with the asbestos; but taking the mean of 15·65 parts, it would appear that a twenty-fourth part of the acid originally in the vessel *a* had passed, through the influence of the electric current, from *a* into *b*.

528. In comparing the difference of acid in A and B, the necessary equality of weight was considered as of no consequence, because the solution was at first neutral, and would not, therefore, affect the test liquids, and all the evolved acid would be in B, and the free alkali in A. The solution in A required 3·2 measures of the prepared acid (525.) to neutralize it, and the solution in B required also 3·2 measures of the soda solution (525.) to neutralize it. As the asbestos must have removed a little acid and alkali from the glasses, these quantities are by so much too small; and therefore it would appear that about a tenth of the acid originally in the vessel A had been transferred into B during the continuance of the electric action.

529. In another similar experiment, whilst a thirty-fifth part of the acid passed from *a* to *b* in the free acid vessels, between a tenth and an eleventh passed from A to B in the combined acid vessels. Other experiments of the same kind gave similar results.

530. The variation of electro-chemical decomposition, the transfer of elements and their accumulation at the poles, according as the substance submitted to action consists of particles opposed more or less in their chemical affinity, together with the consequent influence of the latter circumstances, are sufficiently obvious in these cases, where sulphuric acid is acted upon in the *same quantity* by the *same* electric current, but in one case opposed to the comparatively weak affinity of water for it, and in the other to the stronger one of soda. In the latter case the quantity transferred is from two and a half to three times what it is in the former; and it appears therefore very evident that the transfer is greatly dependent upon the mutual action of the particles of the decomposing bodies*.

* See the note to (675).—*Dec.* 1833.

531. In some of the experiments the acid from the vessels *a* and *b* was neutralized by ammonia, then evaporated to dryness, heated to redness, and the residue examined for sulphates. In these cases more sulphate was always obtained from *a* than from *b*; showing that it had been impossible to exclude saline bases (derived from the asbestos, the glass, or perhaps impurities originally in the acid,) and that they had helped in transferring the acid into *b*. But the quantity was small, and the acid was principally transferred by relation to the water present.

532. I endeavoured to arrange certain experiments by which saline solutions should be decomposed against surfaces of water; and at first worked with the electric machine upon a piece of bibulous paper, or asbestos moistened in the solution, and in contact at its two extremities with pointed pieces of paper moistened in pure water, which served to carry the electric current to and from the solution in the middle piece. But I found numerous interfering difficulties. Thus, the water and solutions in the pieces of paper could not be prevented from mingling at the point where they touched. Again, sufficient acid could be derived from the paper connected with the discharging train, or it may be even from the air itself, under the influence of electric action, to neutralize the alkali developed at the positive extremity of the decomposing solution, and so not merely prevent its appearance, but actually transfer it on to the metal termination: and, in fact, when the paper points were not allowed to touch there, and the machine was worked until alkali was evolved at the delivering or positive end of the turmeric paper, containing the sulphate of soda solution, it was merely necessary to place the opposite receiving point of the paper connected with the discharging train, which had been moistened by distilled water, upon the brown turmeric point and press them together, when the alkaline effect immediately disappeared.

533. The experiment with sulphate of magnesia already described (495.) is a case in point, however, and shows most clearly that the sulphuric acid and magnesia contributed to each other's transfer and final evolution, exactly as the same acid and soda affected each other in the results just given (527, &c.); and that so soon as the magnesia advanced beyond the reach of the acid, and found no other substance with which it could

combine, it appeared in its proper character, and was no longer able to continue its progress towards the negative pole.

534. The theory I have ventured to put forth appears to me to explain all the prominent features of electro-chemical decomposition in a satisfactory manner.

535. In the first place, it explains why, in all ordinary cases, the evolved substances *appear only at the poles*; for the poles are the limiting surfaces of the decomposing substance, and except at them, every particle finds other particles having a contrary tendency with which it can combine.

536. Then it explains why, in numerous cases, the elements or evolved substances are not *retained* by the poles; and this is no small difficulty in those theories which refer the decomposing effect directly to the attractive power of the poles. If, in accordance with the usual theory, a piece of platina be supposed to have sufficient power to attract a particle of hydrogen from the particle of oxygen with which it was the instant before combined, there seems no sufficient reason, nor any fact, except those to be explained, which show why it should not, according to analogy with all ordinary attractive forces, as those of gravitation, magnetism, cohesion, chemical affinity, &c., *retain* that particle which it had just before taken from a distance and from previous combination. Yet it does not do so, but allows it to escape freely. Nor does this depend upon its assuming the gaseous state, for acids and alkalis, &c., are left equally at liberty to diffuse themselves through the fluid surrounding the pole, and show no particular tendency to combine with or adhere to the latter. And though there are plenty of cases where combination with the pole does take place, they do not at all explain the instances of non-combination, and do not therefore in their particular action reveal the general principle of decomposition.

537. But in the theory that I have just given, the effect appears to be a natural consequence of the action: the evolved substances are *expelled* from the decomposing mass (518. 519.), not *drawn out by an attraction* which ceases to act on one particle without any assignable reason, while it continues to act on another of the same kind: and whether the poles be metal, water, or air, still the substances are evolved, and are sometimes set free, whilst at others they unite to the matter of the poles,

according to the chemical nature of the latter, *i. e.* their chemical relation to those particles which are leaving the substance under operation.

538. The theory accounts for the *transfer of elements* in a manner which seems to me at present to leave nothing unexplained; and it was, indeed, the phenomena of transfer in the numerous cases of decomposition of bodies rendered fluid by heat (380. 402.), which, in conjunction with the experiments in air, led to its construction. Such cases as the former where binary compounds of easy decomposability are acted upon, are perhaps the best to illustrate the theory.

539. Chloride of lead, for instance, fused in a bent tube (400.), and decomposed by platina wires, evolves lead, passing to what is usually called the negative pole, and chlorine, which being evolved at the positive pole, is in part set free, and in part combines with the platina. The chloride of platina formed, being soluble in the chloride of lead, is subject to decomposition, and the platina itself is gradually transferred across the decomposing matter, and found with the lead at the negative pole.

540. Iodide of lead evolves abundance of lead at the negative pole, and abundance of iodine at the positive pole.

541. Chloride of silver furnishes a beautiful instance, especially when decomposed by silver wire poles. Upon fusing a portion of it on a piece of glass, and bringing the poles into contact with it, there is abundance of silver evolved at the negative pole, and an equal abundance absorbed at the positive pole, for no chlorine is set free: and by careful management, the negative wire may be withdrawn from the fused globule as the silver is reduced there, the latter serving as the continuation of the pole, until a wire or thread of revived silver, five or six inches in length, is produced; at the same time the silver at the positive pole is as rapidly dissolved by the chlorine, which seizes upon it, so that the wire has to be continually advanced as it is melted away. The whole experiment includes the action of only two elements, silver and chlorine, and illustrates in a beautiful manner their progress in opposite directions, parallel to the electric current, which is for the time giving a uniform general direction to their mutual affinities (524.).

542. According to my theory, an element or a substance not decomposable under the circumstances of the experiment, (as, for instance, a dilute acid or alkali,) should not be transferred

or pass from pole to pole, unless it be in chemical relation to some other element or substance tending to pass in the opposite direction, for the effect is considered as essentially due to the mutual relation of such particles. But the theories attributing the determination of the elements to the attractions and repulsions of the poles require no such condition, *i. e.* there is no reason apparent why the attraction of the positive pole, and the repulsion of the negative pole, upon a particle of free acid, placed in water between them, should not (with equal currents of electricity) be as strong as if that particle were previously combined with alkali; but, on the contrary, as they have not a powerful chemical affinity to overcome, there is every reason to suppose they would be stronger, and would sooner bring the acid to rest at the positive pole*. Yet such is not the case, as has been shown by the experiments on free and combined acid (526. 528.).

543. Neither does M. de la Rive's theory, as I understand it, *require* that the particles should be in combination: it does not even admit, where there are two sets of particles capable of combining with and passing by each other, that they do combine, but supposes that they travel as separate compounds of matter and electricity. Yet in fact the free substance *cannot* travel, the combined one *can*.

544. It is very difficult to find cases amongst solutions or fluids which shall illustrate this point, because of the difficulty of finding two fluids which shall conduct, shall not mingle, and in which an element evolved from one shall not find a combinable element in the other. *Solutions* of acids or alkalies will not answer, because they exist by virtue of an attraction; and increasing the solubility of a body in one direction, and diminishing it in the opposite, is just as good a reason for transfer, as modifying the affinity between the acids and alkalies themselves †. Nevertheless the case of sulphate of magnesia is in point (494. 495.), and shows that *one element or principle only* has no power of transference or of passing towards either pole.

545. Many of the metals, however, in their solid state, offer very fair instances of the kind required. Thus, if a plate of platina be used as the positive pole in a solution of sulphuric

* Even Sir Humphry Davy considered the attraction of the pole as being communicated from one particle to another of the *same* kind (483).

† See the note to 675.—*Dec.* 1838.

acid, oxygen will pass towards it, and so will acid; but these are not substances having such chemical relation to the platina as, even under the favourable condition superinduced by the current (518. 524.), to combine with it; the platina therefore remains where it was first placed, and has no tendency to pass towards the negative pole. But if a plate of iron, zinc or copper, be substituted for the platina, then the oxygen and acid can combine with these, and the metal immediately begins to travel (as an oxide) to the opposite pole, and is finally deposited there. Or if, retaining the platina pole, a fused chloride, as of lead, zinc, silver, &c., be substituted for the sulphuric acid, then, as the platina finds an element it can combine with, it enters into union, acts as other elements do in cases of voltaic decomposition, is rapidly transferred across the melted matter, and expelled at the negative pole.

546. I can see but little reason in the theories referring the electro-chemical decomposition to the attractions and repulsions of the poles, and I can perceive none in M. de la Rive's theory, why the metal of the positive pole should not be transferred across the intervening conductor, and deposited at the negative pole, even when it cannot act chemically upon the element of the fluid surrounding it. It cannot be referred to the attraction of cohesion preventing such an effect; for if the pole be made of the lightest spongy platina, the effect is the same. Or if gold precipitated by sulphate of iron be diffused through the solution, still accumulation of it at the negative pole will not take place; and yet in it the attraction of cohesion is almost perfectly overcome, the particles are so small as to remain for hours in suspension, and are perfectly free to move by the slightest impulse towards either pole; and *if in relation* by chemical affinity to any substance present, are powerfully determined to the negative pole*.

* In making this experiment, care must be taken that no substance be present that can act chemically on the gold. Although I used the metal very carefully washed, and diffused through dilute sulphuric acid, yet in the first instance I obtained gold at the negative pole, and the effect was repeated when the platina poles were changed. But on examining the clear liquor in the cell, after subsidence of the metallic gold, I found a little of that metal in solution, and a little chlorine was also present. I therefore well washed the gold which had thus been subjected to voltaic action, diffused it through other pure dilute sulphuric acid, and then found, that on subjecting it to the action of the pile, not the slightest tendency to the negative pole could be perceived.

547. In support of these arguments, it may be observed, that as yet no determination of a substance to a pole, or tendency to obey the electric current, has been observed (that I am aware of,) in cases of mere mixture; *i. e.* a substance diffused through a fluid, but having no sensible chemical affinity with it, or with substances that may be evolved from it during the action, does not in any case seem to be affected by the electric current. Pulverised charcoal was diffused through dilute sulphuric acid, and subjected with the solution to the action of a voltaic battery, terminated by platina poles; but not the slightest tendency of the charcoal to the negative pole could be observed. Sublimed sulphur was diffused through similar acid, and submitted to the same action, a silver plate being used as the negative pole; but the sulphur had no tendency to pass to that pole, the silver was not tarnished, nor did any sulphuretted hydrogen appear. The case of magnesia and water (495. 533.), with those of comminuted metals in certain solutions (546.), are also of this kind; and, in fact, substances which have the instant before been powerfully determined towards the pole, as magnesia from sulphate of magnesia, become entirely *indifferent to it* the moment they assume their independent state, and pass away, diffusing themselves through the surrounding fluid.

548. There are, it is true, many instances of insoluble bodies being acted upon, as glass, sulphate of baryta, marble, slate, basalt, &c., but they form no exception; for the substances they give up are in direct and strong relation as to chemical affinity with those which they find in the surrounding solution, so that these decompositions enter into the class of ordinary effects.

549. It may be expressed as a general consequence, that the more directly bodies are opposed to each other in chemical affinity, the more *ready* is their separation from each other in cases of electro-chemical decomposition, *i. e.* provided other circumstances, as insolubility, deficient conducting power, proportions, &c., do not interfere. This is well known to be the case with water and saline solutions; and I have found it to be equally true with *dry* chlorides, iodides, salts, &c., rendered subject to electro-chemical decomposition by fusion (402.). So that in applying the voltaic battery for the purpose of decom-

posing bodies not yet resolved into forms of matter simpler than their own, it must be remembered, that success may depend not upon the weakness, or failure upon the strength, of the affinity by which the elements sought for are held together, but contrariwise; and then modes of application may be devised, by which, in *association* with ordinary chemical powers, and the assistance of fusion (394. 417.), we may be able to penetrate much further than at present into the constitution of our chemical elements.

550. Some of the most beautiful and surprising cases of electro-chemical decomposition and *transfer* which Sir Humphry Davy described in his celebrated paper*, were those in which acids were passed through alkalies, and alkalies or earths through acids †; and the way in which substances having the most powerful attractions for each other were thus prevented from combining, or, as it is said, had their natural affinity destroyed or suspended throughout the whole of the circuit, excited the utmost astonishment. But if I be right in the view I have taken of the effects, it will appear, that that which made the *wonder*, is in fact the *essential condition* of transfer and decomposition, and that the more alkali there is in the course of an acid, the more will the transfer of that acid be facilitated from pole to pole; and perhaps a better illustration of the difference between the theory I have ventured, and those previously existing, cannot be offered than the views they respectively give of such facts as these.

551. The instances in which sulphuric acid could not be passed through baryta, or baryta through sulphuric acid ‡, because of the precipitation of sulphate of baryta, enter within the pale of the law already described (380. 412.), by which liquidity is so generally required for conduction and decomposition. In assuming the solid state of sulphate of baryta, these bodies became virtually non-conductors to electricity of so low a tension as that of the voltaic battery, and the power of the latter over them was almost infinitely diminished.

552. The theory I have advanced accords in a most satisfactory manner with the fact of an element or substance finding its place of rest, or rather of evolution, sometimes at one

* Philosophical Transactions, 1807, p. 1.

† Ibid. p. 24, &c.

‡ Ibid. p. 25, &c.

pole and sometimes at the other. Sulphur illustrates this effect very well*. When sulphuric acid is decomposed by the pile, sulphur is evolved at the negative pole; but when sulphuret of silver is decomposed in a similar way (436.), then the sulphur appears at the positive pole; and if a hot platina pole be used so as to vaporize the sulphur evolved in the latter case, then the relation of that pole to the sulphur is exactly the same as the relation of the same pole to oxygen upon its immersion in water. In both cases the element evolved is liberated at the pole, but not retained by it; but by virtue of its elastic, uncombinable, and immiscible condition passes away into the surrounding medium. The sulphur is evidently determined in these opposite directions by its opposite chemical relations to oxygen and silver; and it is to such relations generally that I have referred all electro-chemical phenomena. Where they do not exist, no electro-chemical action can take place. Where they are strongest, it is most powerful; where they are reversed, the direction of transfer of the substance is reversed with them.

553. *Water* may be considered as one of those substances which can be made to pass to *either* pole. When the poles are immersed in dilute sulphuric acid (527.), acid passes towards the positive pole, and water towards the negative pole; but when they are immersed in dilute alkali, the alkali passes towards the negative pole, and water towards the positive pole.

554. Nitrogen is another substance which is considered as determinable to either pole; but in consequence of the numerous compounds which it forms, some of which pass to one pole, and some to the other, I have not always found it easy to determine the true circumstances of its appearance. A pure strong solution of ammonia is so bad a conductor of electricity that it is scarcely more decomposable than pure water; but if sulphate of ammonia be dissolved in it, then decomposition takes place very well; nitrogen almost pure, and in some cases quite, is evolved at the positive pole, and hydrogen at the negative pole.

* At 681 and 757 of Series VII. will be found corrections of the statement here made respecting sulphur and sulphuric acid. At present there is no well-ascertained fact which proves that the same body can go directly to *either* of the two poles at pleasure.—Dec. 1838.

555. On the other hand, if a strong solution of nitrate of ammonia be decomposed, oxygen appears at the positive pole, and hydrogen, with sometimes nitrogen, at the negative pole. If fused nitrate of ammonia be employed, hydrogen appears at the negative pole, mingled with a little nitrogen. Strong nitric acid yields plenty of oxygen at the positive pole, but no gas (only nitrous acid,) at the negative pole. Weak nitric acid yields the oxygen and hydrogen of the water present, the acid apparently remaining unchanged. Strong nitric acid with nitrate of ammonia dissolved in it, yields a gas at the negative pole, of which the greater part is hydrogen, but apparently a little nitrogen is present. I believe that in some of these cases a little nitrogen appeared at the negative pole. I suspect, however, that in all these, and in all former cases, the appearance of the nitrogen at the positive or negative pole is entirely a secondary effect, and not an immediate consequence of the decomposing power of the electric current*.

556. A few observations on what are called the *poles* of the voltaic battery now seem necessary. The poles are merely the surfaces or doors by which the electricity enters into or passes out of the substance suffering decomposition. They limit the extent of that substance in the course of the electric current, being its *terminations* in that direction: hence the elements evolved pass so far and no further.

557. Metals make admirable poles, in consequence of their high conducting power, their immiscibility with the substances generally acted upon, their solid form, and the opportunity afforded of selecting such as are not chemically acted upon by ordinary substances.

558. Water makes a pole of difficult application, except in a few cases (494.), because of its small conducting power, its miscibility with most of the substances acted upon, and its general relation to them in respect to chemical affinity. It consists of elements, which in their electrical and chemical relations are directly and powerfully opposed, yet combining to produce a body more neutral in its character than any other. So that there are but few substances which do not come into relation, by chemical affinity, with water or one of its elements;

* Refer for proof of the truth of this supposition to 748, 752, &c.—Dec. 1838.

and therefore either the water or its elements are transferred and assist in transferring the infinite variety of bodies which, in association with it, can be placed in the course of the electric current. Hence the reason why it so rarely happens that the evolved substances rest at the first surface of the water, and why it therefore does not exhibit the ordinary action of a pole.

559. Air, however, and some gases are free from the latter objection, and may be used as poles in many cases (461, &c.); but, in consequence of the extremely low degree of conducting power belonging to them, they cannot be employed with the voltaic apparatus. This limits their use; for the voltaic apparatus is the only one as yet discovered which supplies sufficient quantity of electricity (371. 376.) to effect electro-chemical decomposition with facility.

560. When the poles are liable to the chemical action of the substances evolved, either simply in consequence of their natural relation to them, or of that relation aided by the influence of the current (518.), then they suffer corrosion, and the parts dissolved are subject to transference, in the same manner as the particles of the body originally under decomposition. An immense series of phenomena of this kind might be quoted in support of the view I have taken of the cause of electro-chemical decomposition, and the transfer and evolution of the elements. Thus platina being made the positive and negative poles in a solution of sulphate of soda, has no affinity or attraction for the oxygen, hydrogen, acid, or alkali evolved, and refuses to combine with or retain them. Zinc can combine with the oxygen and acid; at the positive pole it does combine, and immediately begins to travel as oxide towards the negative pole. Charcoal, which cannot combine with the metals, if made the negative pole in a metallic solution, refuses to unite to the bodies which are ejected from the solution upon its surface; but if made the positive pole in a dilute solution of sulphuric acid, it is capable of combining with the oxygen evolved there, and consequently unites with it, producing both carbonic acid and carbonic oxide in abundance.

561. A great advantage is frequently supplied, by the opportunity afforded amongst the metals of selecting a substance for the pole, which shall or shall not be acted upon by the elements

to be evolved. The consequent use of platina is notorious. In the decomposition of sulphuret of silver and other sulphurets, a positive silver pole is superior to a platina one, because in the former case the sulphur evolved there combines with the silver, and the decomposition of the original sulphuret is rendered evident; whereas in the latter case it is dissipated, and the assurance of its separation at the pole not easily obtained.

562. The effects which take place when a succession of conducting decomposable and undecomposable substances are placed in the electric circuit, as, for instance, of wires and solutions, or of air and solutions (465. 469.), are explained in the simplest possible manner by the theoretical view I have given. In consequence of the reaction of the constituents of each portion of decomposable matter, affected as they are by the supervention of the electric current (524.), portions of the proximate or ultimate elements proceed in the direction of the current as far as they find matter of a contrary kind capable of effecting their transfer, and being equally affected by them; and where they cease to find such matter, they are evolved in their free state, *i. e.* upon the surfaces of metal or air bounding the extent of decomposable matter in the direction of the current.

563. Having thus given my theory of the mode in which electro-chemical decomposition is effected, I will refrain for the present from entering upon the numerous general considerations which it suggests, wishing first to submit it to the test of publication and discussion.

Royal Institution,
June 1833.

SIXTH SERIES.

§ 12. *On the power of Metals and other Solids to induce the Combination of Gaseous Bodies.*

Received November 30, 1833,—Read January 11, 1834.

564. THE conclusion at which I have arrived in the present communication may seem to render the whole of it unfit to form part of a series of researches in electricity; since, remarkable as the phenomena are, the power which produces them is not to be considered as of an electric origin, otherwise than as all attraction of particles may have this subtile agent for their common cause. But as the effects investigated arose out of electrical researches, as they are directly connected with other effects which are of an electric nature, and must of necessity be understood and guarded against in a very extensive series of electro-chemical decompositions (707.), I have felt myself fully justified in describing them in this place.

365. Believing that I had proved (by experiments hereafter to be described (705.),) the constant and definite chemical action of a certain quantity of electricity, whatever its intensity might be, or however the circumstances of its transmission through either the body under decomposition or the more perfect conductors were varied, I endeavoured upon that result to construct a new measuring instrument, which from its use might be called, at least provisionally, a *Volta-electrometer* (739.)*.

566. During the course of the experiments made to render the instrument efficient, I was occasionally surprised at observing a deficiency of the gases resulting from the decompositions of water, and at last an actual disappearance of portions which had been evolved, collected, and measured. The circumstances of the disappearance were these. A glass tube, about twelve inches in length and $\frac{3}{4}$ ths of an inch in diameter, had two platina poles fixed into its upper, hermetically sealed,

* Or Voltmeter.—*Dec.* 1833.

extremity: the poles, where they passed through the glass, were of wire; but terminated below in plates, which were soldered to the wires with gold (Plate V. fig. 56.). The tube was filled with dilute sulphuric acid, and inverted in a eup of the same fluid; a voltaic battery was connected with the two wires, and sufficient oxygen and hydrogen evolved to occupy $\frac{4}{5}$ ths of the tube, or by the graduation, 116 parts. On separating the tube from the voltaic battery the volume of gas immediately began to diminish, and in about five hours only $13\frac{1}{2}$ parts remained, and these ultimately disappeared.

567. It was found by various experiments, that this effect was not due to the escape or solution of the gas, nor to recombination of the oxygen or hydrogen in consequence of any peculiar condition *they* might be supposed to possess under the circumstances; but to be occasioned by the action of one or both of the poles within the tube upon the gas around them. On disuniting the poles from the pile after they had acted upon dilute sulphuric acid, and introducing them into separate tubes containing mixed oxygen and hydrogen, it was found that the *positive* pole effected the union of the gases, but the negative pole apparently not (588.). It was ascertained also that no action of a sensible kind took place between the positive pole with oxygen or hydrogen alone.

568. These experiments reduced the phenomena to the consequence of a power possessed by the platina, after it had been the positive pole of a voltaic pile, of causing the combination of oxygen and hydrogen at common, or even at low, temperatures. This effect is, as far as I am aware, altogether new, and was immediately followed out to ascertain whether it was really of an electric nature, and how far it would interfere with the determination of the quantities evolved in the cases of electro-chemical decomposition required in the fourteenth section of these Researches.

569. Several platina plates were prepared (fig. 57.). They were nearly half an inch wide, and two inches and a half long: some were $\frac{1}{20}$ dth of an inch, others not more than $\frac{1}{60}$ dth, whilst some were as much as $\frac{1}{7}$ th of an inch in thickness. Each had a piece of platina wire, about seven inches long, soldered to it by pure gold. Then a number of glass tubes were prepared: they were about nine or ten inches in length, $\frac{5}{8}$ ths

of an inch in internal diameter, were sealed hermetically at one extremity, and were graduated. Into these tubes was put a mixture of two volumes of hydrogen and one of oxygen, at the water pneumatic trough, and when one of the plates described had been connected with the positive or negative pole of the voltaic battery for a given time, or had been otherwise prepared, it was introduced through the water into the gas within the tube; the whole set aside in a test-glass (fig. 58.), and left for a longer or shorter period, that the action might be observed.

570. The following result may be given as an illustration of the phenomenon to be investigated. Diluted sulphuric acid, of the specific gravity 1.336, was put into a glass jar, in which was placed also a large platina plate, connected with the negative end of a voltaic battery of forty pairs of four-inch plates, with double coppers, and moderately charged. One of the plates above described (569.) was then connected with the positive extremity, and immersed in the same jar of acid for five minutes, after which it was separated from the battery, washed in distilled water and introduced through the water of the pneumatic trough into a tube containing the mixture of oxygen and hydrogen (569.). The volume of gases immediately began to lessen, the diminution proceeding more and more rapidly until about $\frac{3}{4}$ ths of the mixture had disappeared. The upper end of the tube became quite warm, the plate itself so hot that the water boiled as it rose over it; and in less than a minute a cubical inch and a half of the gases were gone, having been combined by the power of the platina, and converted into water.

571. This extraordinary influence acquired by the platina at the positive pole of the pile, is exerted far more readily and effectively on oxygen and hydrogen than on any other mixture of gases that I have tried. One volume of nitrous gas was mixed with a volume of hydrogen, and introduced into a tube with a plate which had been made positive in the dilute sulphuric acid for four minutes (570.). There was no sensible action in an hour; being left for thirty-six hours, there was a diminution of about one eighth of the whole volume. Action had taken place, but it had been very feeble.

572. A mixture of two volumes of nitrous oxide with one

volume of hydrogen was put with a plate similarly prepared into a tube (569. 570.). This also showed no action immediately; but in thirty-six hours nearly a fourth of the whole had disappeared, *i.e.* about half of a cubic inch. By comparison with another tube containing the same mixture without a plate, it appeared that a part of the diminution was due to solution, and the other part to the power of the platina; but the action had been very slow and feeble.

573. A mixture of one volume olefiant gas and three volumes oxygen was not affected by such a platina plate, even though left together for several days (640. 641.).

574. A mixture of two volumes carbonic oxide and one volume oxygen was also unaffected by the prepared platina plate in several days (645. &c.).

575. A mixture of equal volumes of chlorine and hydrogen was used in several experiments, with plates prepared in a similar manner (570.). Diminution of bulk soon took place; but when after thirty-six hours the experiments were examined, it was found that nearly all the chlorine had disappeared, having been absorbed, principally by the water, and that the original volume of hydrogen remained unchanged. No combination of the gases, therefore, had here taken place.

576. Reverting to the action of the prepared plates on mixtures of oxygen and hydrogen (570.), I found that the power, though gradually diminishing in all cases, could still be retained for a period, varying in its length with circumstances. When tubes containing plates (569.) were supplied with fresh portions of mixed oxygen and hydrogen as the previous portions were condensed, the action was found to continue for above thirty hours, and in some cases slow combination could be observed even after eighty hours; but the continuance of the action greatly depended upon the purity of the gases used (638.).

577. Some plates (569.) were made positive for four minutes in dilute sulphuric acid of specific gravity 1.336: they were rinsed in distilled water, after which two were put into a small bottle and closed up, whilst others were left exposed to the air. The plates preserved in the limited portion of air were found to retain their power after eight days, but those exposed to the atmosphere had lost their force almost entirely in twelve hours

and in some situations, where eurrents existed, in a much shorter time.

578. Plates were made positive for five minutes in sulphuric acid, specific gravity 1.336. One of these was retained in similar acid for eight minutes after separation from the battery; it then acted on mixed oxygen and hydrogen with apparently undiminished vigour. Others were left in similar acid for forty hours, and some even for eight days, after the electrization, and then acted as well in combining oxygen and hydrogen gas as those which were used immediately after electrization.

579. The effect of a solution of caustic potassa in preserving the platina plates was tried in a similar manner. After being retained in such a solution for forty hours, they acted exceedingly well on oxygen and hydrogen, and one caused such rapid condensation of the gases, that the plate became much heated, and I expected the temperature would have risen to ignition.

580. When similarly prepared plates (569.) had been put into distilled water for forty hours, and then introduced into mixed oxygen and hydrogen, they were found to act but very slowly and feebly as compared with those which had been preserved in acid or alkali. When, however, the quantity of water was but small, the power was very little impaired after three or four days. As the water had been retained in a wooden vessel, portions of it were redistilled in glass, and this was found to preserve prepared plates for a great length of time. Prepared plates were put into tubes with this water and closed up; some of them, taken out at the end of twenty-four days, were found very active on mixed oxygen and hydrogen; others, which were left in the water for fifty-three days, were still found to cause the combination of the gases. The tubes had been closed only by corks.

581. The act of combination always seemed to diminish, or apparently exhaust, the power of the platina plate. It is true, that in most, if not all instances, the combination of the gases, at first insensible, gradually increased in rapidity, and sometimes reached to explosion; but when the latter did not happen, the rapidity of combination diminished; and although fresh portions of gas were introduced into the tubes, the combination went on more and more slowly, and at last ceased altogether. The first effect of an increase in the rapidity of combination dependent

in part upon the water flowing off from the platina plate, and allowing a better contact with the gas, and in part upon the heat evolved during the progress of the combination (630.). But notwithstanding the effect of these causes, diminution, and at last cessation of the power, always occurred. It must not, however, be unnoticed, that the purer the gases subjected to the action of the plate, the longer was its combining power retained. With the mixture evolved at the poles of the voltaic pile, in pure dilute sulphuric acid, it continued longest; and with oxygen and hydrogen, of perfect purity, it probably would not be diminished at all.

582. Different modes of treatment applied to the platina plate, after it had ceased to be the positive pole of the pile, affected its power very curiously. A plate which had been a positive pole in diluted sulphuric acid of specific gravity 1.336 for four or five minutes, if rinsed in water and put into mixed oxygen and hydrogen, would act very well, and condense perhaps one cubic inch and a half of gas in six or seven minutes; but if that same plate, instead of being merely rinsed, had been left in distilled water for twelve or fifteen minutes, or more, it would rarely fail, when put into the oxygen and hydrogen, of becoming, in the course of a minute or two, ignited, and would generally explode the gases. Occasionally the time occupied in bringing on the action extended to eight or nine minutes, and sometimes even to forty minutes, and yet ignition and explosion would result. This effect is due to the removal of a portion of acid which otherwise adheres firmly to the plate*.

583. Occasionally the platina plates (569.), after being made the positive pole of the battery, were washed, wiped with filtering-paper or a cloth, and washed and wiped again. Being then introduced into mixed oxygen and hydrogen, they acted apparently as if they had been unaffected by the treatment. Sometimes the tubes containing the gas were opened in the air for an instant, and the plates put in dry; but no sensible difference in action was perceived, except that it commenced sooner.

584. The power of heat in altering the action of the prepared platina plates was also tried (595.). Plates which had been rendered positive in dilute sulphuric acid for four minutes were well washed in water, and heated to redness in the flame

* In proof that this is the case, refer to 1038.—Dec. 1833.

of a spirit-lamp: after this they acted very well on mixed oxygen and hydrogen. Others, which had been heated more powerfully by the blowpipe, acted afterwards on the gases, though not so powerfully as the former. Hence it appears that heat does not take away the power acquired by the platina at the positive pole of the pile: the occasional diminution of force seemed always referable to other causes than the mere heat. If, for instance, the plate had not been well washed from the acid, or if the flame used was carbonaceous, or was that of an alcohol lamp trimmed with spirit containing a little acid, or having a wick on which salt, or other extraneous matter, had been placed, then the power of the plate was quickly and greatly diminished (634. 636.).

585. This remarkable property was conferred upon platina when it was made the positive pole in sulphuric acid of specific gravity 1.336, or when it was considerably weaker, or when stronger, even up to the strength of oil of vitriol. Strong and dilute nitric acid, dilute acetic acid, solutions of tartaric, citric, and oxalic acids, were used with equal success. When muriatic acid was used, the plates acquired the power of condensing the oxygen and hydrogen, but in a much inferior degree.

586. Plates which were made positive in solution of caustic potassa did not show any sensible action upon the mixed oxygen and hydrogen. Other plates made positive in solutions of carbonates of potassa and soda exhibited the action, but only in a feeble degree.

587. When a neutral solution of sulphate of soda, or of nitre, or of chlorate of potassa, or of phosphate of potassa, or acetate of potassa, or sulphate of copper, was used, the plates, rendered positive in them for four minutes, and then washed in water, acted very readily and powerfully on the mixed oxygen and hydrogen.

588. It became a very important point, in reference to the *cause* of this action of the platina, to determine whether the *positive* pole *only* could confer it (567.), or whether, notwithstanding the numerous contrary cases, the *negative* pole might not have the power when such circumstances as could interfere with or prevent the action were avoided. Three plates were therefore rendered negative, for four minutes in diluted sulphuric acid of specific gravity 1.336, washed in distilled water,

and put into mixed oxygen and hydrogen. *All of them acted*, though not so strongly as they would have done if they had been rendered positive. Each combined about a cubical inch and a quarter of the gases in twenty-five minutes. On every repetition of the experiment the same result was obtained; and when the plates were retained in distilled water for ten or twelve minutes, before being introduced into the gas (582.), the action was very much quickened.

589. But when there was any metallie or other substance present in the acid, which could be precipitated on the negative plate, then that plate ceased to act upon the mixed oxygen and hydrogen.

590. These experiments led to the expectation that the power of causing oxygen and hydrogen to combine, which could be conferred upon any piece of platina by making it the positive pole of a voltaic pile, was not essentially dependent upon the action of the pile, or upon any structure or arrangement of parts it might receive whilst in association with it, but belonged to the platina *at all times*, and was *always effective* when the surface was *perfectly clean*. And though, when made the *positive* pole of the pile in acids, the circumstances might well be considered as those which would cleanse the surface of the platina in the most effectual manner, it did not seem impossible that ordinary operations should produce the same result, although in a less eminent degree.

591. Accordingly, a platina plate (569.) was cleaned by being rubbed with a cork, a little water, and some coal-fire ashes upon a glass plate: being washed, it was put into mixed oxygen and hydrogen, and was found to act at first slowly, and then more rapidly. In an hour, a cubical inch and a half had disappeared.

592. Other plates were cleaned with ordinary sand-paper and water; others with chalk and water; others with emery and water; others, again, with black oxide of manganese and water; and others with a piece of charcoal and water. All of these acted in tubes of oxygen and hydrogen, causing combination of the gases. The action was by no means so powerful as that produced by plates having been in communication with the battery; but from one to two cubical inches of the gases disappeared, in periods extending from twenty-five to eighty or ninety minutes.

593. Upon cleaning the plates with a cork, ground emery, and dilute sulphuric acid, they were found to act still better. In order to simplify the conditions, the cork was dismissed, and a picce of platina foil used instead; still the effect took place. Then the acid was dismissed, and a solution of *potassa* used, but the effect occurred as before.

594. These results are abundantly sufficient to show that the mere mechanical cleansing of the surface of the platina is sufficient to enable it to exert its combining power over oxygen and hydrogen at common temperatures.

595. I now tried the effect of heat in conferring this property upon platina (584.). Plates which had no action on the mixture of oxygen and hydrogen were heated by the flame of a freshly trimmed spirit-lamp, urged by a mouth blowpipe, and when cold were put into tubes of the mixed gases: they acted slowly at first, but after two or three hours condensed nearly all the gases.

596. A plate of platina, which was about one inch wide and two and three quarters in length, and which had not been used in any of the preceding experiments, was curved a little so as to enter a tube, and left in a mixture of oxygen and hydrogen for thirtecn hours: not the slightest action or combination of the gases occurred. It was withdrawn at the pneumatic trough from the gas through the water, heated red hot by the spirit-lamp and blowpipe, and then returned when cold into the *same* portion of gas. In the course of a few minutes diminution of the gases could be observed, and in forty-five minutes about one cubical inch and a quarter had disappeared. In many other experiments platina plates when heated were found to acquire the power of combining oxygen and hydrogen.

597. But it happened not unfrequently that plates, after being heated, showed no power of combining oxygen and hydrogen gases, though left undisturbed in them for two hours. Sometimes also it would happen that a plate which, having been heated to dull redness, acted feebly, upon being heated to whiteness ceased to act; and at other times a plate which, having been slightly heated, did not act, was rendered active by a more powerful ignition.

598. Though thus uncertain in its action, and though often diminishing the power given to the plates at the positive pole

of the pile (584.), still it is evident that heat can render platina active, which before was inert (595.) The cause of its occasional failure appears to be due to the surface of the metal becoming soiled, either from something previously adhering to it, which is made to adhere more closely by the action of the heat, or from matter communicated from the flame of the lamp, or from the air itself. It often happens that a polished plate of platina, when heated by the spirit-lamp and a blowpipe, becomes dulled and clouded on its surface by something either formed or deposited there; and this, and much less than this, is sufficient to prevent it from exhibiting the curious power now under consideration (634. 636.). Platina also has been said to combine with carbon; and it is not at all unlikely that in processes of heating, where carbon or its compounds are present, a film of such a compound may be thus formed, and thus prevent the exhibition of the properties belonging to *pure* platina*.

599. The action of alkalis and acids in giving platina this property was now experimentally examined. Platina plates (569.) having no action on mixed oxygen and hydrogen, being boiled in a solution of caustic potassa, washed, and then put into the gases, were found occasionally to act pretty well, but at other times to fail. In the latter case I concluded that the impurity upon the surface of the platina was of a nature not to be removed by the mere solvent action of the alkali, for when the plates were rubbed with a little emery, and the same solution of alkali (592.), they became active.

600. The action of acids was far more constant and satisfactory. A platina plate was boiled in dilute nitric acid: being washed and put into mixed oxygen and hydrogen gases, it acted well. Other plates were boiled in strong nitric acid for periods extending from half a minute to four minutes, and then being washed in distilled water, were found to act very well, condensing one cubic inch and a half of gas in the space of eight or nine minutes, and rendering the tube warm (570.).

601. Strong sulphuric acid was very effectual in rendering the platina active. A plate (569.) was heated in it for a minute,

* When heat does confer the property it is only by the destruction or dissipation of organic or other matter which had previously soiled the plate (632. 633. 634.).—*Dec.* 1838.

then washed and put into the mixed oxygen and hydrogen, upon which it acted as well as if it had been made the positive pole of a voltaic pile (570.).

602. Plates which, after being heated or electrized in alkali, or after other treatment, were found inert, immediately received power by being dipped for a minute or two, or even only for an instant, into hot oil of vitriol, and then into water.

603. When the plate was dipped into the oil of vitriol, taken out, and then heated so as to drive off the acid, it did not act, in consequence of the impurity left by the acid upon its surface.

604. Vegetable acids, as acetic and tartaric, sometimes rendered inert platina active, at other times not. This, I believe, depended upon the character of the matter previously soiling the plates, and which may easily be supposed to be sometimes of such a nature as to be removed by these acids, and at other times not. Weak sulphuric acid showed the same difference, but strong sulphuric acid (601.) never failed in its action.

605. The most favourable treatment, except that of making the plate a positive pole in strong acid, was as follows. The plate was held over a spirit-lamp flame, and when hot, rubbed with a piece of potassa fusa (caustic potash), which melting, covered the metal with a coat of very strong alkali, and this was retained fused upon the surface for a second or two*: it was then put into water for four or five minutes to wash off the alkali, shaken, and immersed for about a minute in hot strong oil of vitriol; from this it was removed into distilled water, where it was allowed to remain ten or fifteen minutes to remove the last traces of acid (582.). Being then put into a mixture of oxygen and hydrogen, combination immediately began, and proceeded rapidly; the tube became warm, the platina became red hot, and the residue of the gases was inflamed. This effect could be repeated at pleasure, and thus the maximum phenomenon could be produced without the aid of the voltaic battery.

606. When a solution of tartaric or acetic acid was substituted, in this mode of preparation, for the sulphuric acid, still the plate was found to acquire the same power, and would

* The heat need not be raised so much as to make the alkali tarnish the platina, although if that effect does take place it does not prevent the ultimate action.

often produce explosion in the mixed gases; but the strong sulphuric acid was most certain and powerful.

607. If borax, or a mixture of the carbonates of potash and soda, be fused on the surface of a platina plate, and that plate be well washed in water, it will be found to have acquired the power of combining oxygen and hydrogen, but only in a moderate degree; but if, after the fusion and washing, it be dipped in the hot sulphuric acid (601.), it will become very active.

608. Other metals than platina were then experimented with. Gold and palladium exhibited the power either when made the positive pole of the voltaic battery (570.), or when acted on by hot oil of vitriol (601.). When palladium is used, the action of the battery or acid should be moderated, as that metal is soon acted upon under such circumstances. Silver and copper could not be made to show any effect at common temperatures.

609. There can remain no doubt that the property of inducing combination, which can thus be conferred upon masses of platina and other metals by connecting them with the poles of the battery, or by cleansing processes either of a mechanical or chemical nature, is the same as that which was discovered by Dobereiner*, in 1823, to belong in so eminent a degree to spongy platina, and which was afterwards so well experimented upon and illustrated by MM. Dulong and Thenard†, in 1823. The latter philosophers even quote experiments in which a very fine platina wire, which had been coiled up and digested in nitric, sulphuric, or muriatic acid, became ignited when put into a jet of hydrogen gas‡. This effect I can now produce at pleasure with either wires or plates by the processes described (570. 601. 605.); and by using a smaller plate cut so that it shall rest against the glass by a few points, and yet allow the water to flow off (fig. 59.), the loss of heat is less, the metal is assimilated somewhat to the spongy state, and the probability of failure almost entirely removed.

610. M. Dobereiner refers the effect entirely to an electric action. He considers the platina and hydrogen as forming a voltaic element of the ordinary kind, in which the hydrogen,

* *Annales de Chimie*, tom. xxiv. p. 93.

† *Ibid.* tom. xxiii. p. 440; tom. xxiv. p. 380. ‡ *Ibid.* tom. xxiv. p. 383.

being very highly positive, represents the zine of the usual arrangement, and like it, therefore, attracts oxygen and combines with it*.

611. In the two excellent experimental papers by MM. Dulong and Thenard †, those philosophers show that elevation of temperature favours the action, but does not alter its character; Sir Humphry Davy's incesdeseent platina wire being the same phenomenon with Dobereiner's spongy platina. They show that *all* metals have this power in a greater or smaller degree, and that it is even possessed by such bodies as charcoal, pumice, poreelain, glass, roek crystal, &c., when their temperatures are raised; and that another of Davy's effects, in which oxygen and hydrogen had combined slowly together at a heat below ignition, was really dependent upon the property of the heated glass, which it has in common with the bodies named above. They state that liquids do not show this effect, at least that mereury, at or below the boiling point, has not the power; that it is not due to porosity; that the same body varies very much in its action, according to its state; and that many other gaseous mixtures besides oxygen and hydrogen are affected, and made to act chemically, when the temperature is raised. They think it probable that spongy platina aequires its power from contact with the acid evolved during its reduction, or from the heat itself to which it is then submitted.

612. MM. Dulong and Thenard express themselves with great caution on the theory of this action; but, referring to the decomposing power of metals on ammonia when heated to temperatures not sufficient alone to affect the alkali, they remark that those metals which in this case are most efficacious, are the least so in causing the combination of oxygen and hydrogen; whilst platina, gold, &c., which have least power of decomposing ammonia, have most power of combining the elements of water:—from which they are led to believe, that amongst gases, some tend to *unite* under the influence of metals, whilst others tend to *separate*, and that this property varies in opposite directions with the different metals. At the

* Annales de Chimie, tom. xxiv. pp. 94, 95. Also Bibliothque Universelle, tom. xxiv. p. 54.

† Ibid. tom. xxiii. p. 440; tom. xxiv. p. 380.

close of their second paper they observe, that the action is of a kind that cannot be connected with any known theory; and though it is very remarkable that the effects are transient, like those of most electrical actions, yet they state that the greater number of the results observed by them are inexplicable, by supposing them to be of a purely electric origin.

613. Dr. Fusinieri has also written on this subject, and given a theory which he considers as sufficient to account for the phenomena *. He expresses the immediate cause thus: "The platina determines upon its surface a continual renovation of *concrete laminæ* of the combustible substance of the gases or vapours, which flowing over it are burnt, pass away, and are renewed: this combustion at the surface raises and sustains the temperature of the metal." The combustible substance, thus reduced into imperceptible laminæ, of which the concrete parts are in contact with the oxygen, is presumed to be in a state combinable with the oxygen at a much lower temperature than when it is in the gaseous state, and more in analogy with what is called the nascent condition. That combustible gases should lose their elastic state, and become concrete, assuming the form of exceedingly attenuated but solid strata, is considered as proved by facts, some of which are quoted in the *Giornale di Fisica* for 1824 †; and though the theory requires that they should assume this state at high temperatures, and though the *similar* films of aqueous and other matter are dissipated by the action of heat, still the facts are considered as justifying the conclusion against all opposition of reasoning.

614. The power or force which makes combustible gas or vapour abandon its elastic state in contact with a solid, that it may cover the latter with a thin stratum of its own proper substance, is considered as being neither attraction nor affinity. It is able also to extend liquids and solids in concrete laminæ over the surface of the acting solid body, and consists in a *repulsion*, which is developed from the parts of the solid body by the simple fact of attenuation, and is highest when the attenuation is most complete. The force has a progressive development, and acts most powerfully, or at first, in the direction in which the dimensions of the attenuated mass decrease, and then in the direction of the angles or corners which from

* *Giornale di Fisica*, &c., 1825, tom. viii. p. 259.

† pp. 138, 371.

any cause may exist on the surface. This force not only causes spontaneous diffusion of gases and other substances over the surface, but is considered as very elementary in its nature, and competent to account for all the phenomena of capillarity, chemical affinity, attraction of aggregation, rarefaction, ebullition, volatilization, explosion, and other thermometric effects, as well as inflammation, detonation, &c. &c. It is considered as a form of heat to which the term *native caloric* is given, and is still further viewed as the principle of the two electricities and the two magnetisms.

615. I have been the more anxious to give a correct abstract of Dr. Fusinieri's view, both because I cannot form a distinct idea of the power to which he refers the phenomena, and because of my imperfect knowledge of the language in which the memoir is written. I would therefore beg to refer those who pursue the subject to the memoir itself.

616. Not feeling, however, that the problem has yet been solved, I venture to give the view which seems to me sufficient, upon *known principles*, to account for the effect.

617. It may be observed of this action, that, with regard to platina, it cannot be due to any peculiar, temporary condition, either of an electric or of any other nature: the activity of plates rendered either positive or negative by the pole, or cleaned with such different substances as acids, alkalies, or water; charcoal, emery, ashes, or glass; or merely heated, is sufficient to negative such an opinion. Neither does it depend upon the spongy and porous, or upon the compact and burnished, or upon the massive or the attenuated state of the metal, for in any of these states it may be rendered effective, or its action may be taken away. The only essential condition appears to be a *perfectly clean and metallic surface*, for whenever that is present the platina acts, whatever its form and condition in other respects may be; and though variations in the latter points will very much affect the rapidity, and therefore the visible appearances and secondary effects, of the action, *i. e.* the ignition of the metal and the inflammation of the gases, they, even in their most favourable state, cannot produce any effect unless the condition of a clean, pure, metallic surface be also fulfilled.

618. The effect is evidently produced by most, if not all,

solid bodies, weakly perhaps by many of them, but rising to a high degree in platina. Dulong and Thenard have very philosophically extended our knowledge of the property to its possession by all the metals, and by earths, glass, stones, &c. (611.); and every idea of its being a known and recognised electric action is in this way removed.

619. All the phenomena connected with this subject press upon my mind the conviction that the effects in question are entirely incidental and of a secondary nature; that they are dependent upon the *natural conditions* of gaseous elasticity, combined with the exertion of that attractive force possessed by many bodies, especially those which are solid, in an eminent degree, and probably belonging to all; by which they are drawn into association more or less close, without at the same time undergoing chemical combination, though often assuming the condition of adhesion; and which occasionally leads, under very favourable circumstances, as in the present instance, to the combination of bodies simultaneously subjected to this attraction. I am prepared myself to admit (and probably many others are of the same opinion), both with respect to the attraction of aggregation and of chemical affinity, that the sphere of action of particles extends beyond those other particles with which they are immediately and evidently in union (523.), and in many cases produces effects rising into considerable importance: and I think that this kind of attraction is a determining cause of Dobereiner's effect, and of the many others of a similar nature.

620. Bodies which become wetted by fluids with which they do not combine chemically, or in which they do not dissolve, are simple and well known instances of this kind of attraction.

621. All those cases of bodies which being insoluble in water and not combining with it are hygrometric, and condense its vapour around or upon their surface, are stronger instances of the same power, and approach a little nearer to the cases under investigation. If pulverised clay, protoxide or peroxide of iron, oxide of manganese, charcoal, or even metals, as spongy platina or precipitated silver, be put into an atmosphere containing vapour of water, they soon become moist by virtue of an attraction which is able to condense the vapour upon,

although not to combine it with, the substances; and if, as is well known, these bodies so damped be put into a dry atmosphere, as, for instance, one confined over sulphuric acid, or if they be heated, then they yield up this water again almost entirely, it not being in direct or permanent combination*.

622. Still better instances of the power I refer to, because they are more analogous to the cases to be explained, are furnished by the attraction existing between glass and air, so well known to barometer and thermometer makers, for here the adhesion or attraction is exerted between a solid and gases, bodies having very different physical conditions, having no power of combination with each other, and each retaining, during the time of action, its physical state unchanged†. When mercury is poured into a barometer tube, a film of air will remain between the metal and glass for months, or, as far as is known, for years, for it has never been displaced except by the action of means especially fitted for the purpose. These consist in boiling the mercury, or in other words, of forming an abundance of vapour, which coming in contact with every part of the glass and every portion of surface of the mercury, gradually mingles with, dilutes, and carries off the air attracted by, and adhering to, those surfaces, replacing it by other vapour, subject to an equal or perhaps greater attraction, but which when cooled condenses into the same liquid as that with which the tube is filled.

623. Extraneous bodies, which, acting as nuclei in crystallizing or depositing solutions, cause deposition of substances on them, when it does not occur elsewhere in the liquid, seem to produce their effects by a power of the same kind, *i. e.* a power of attraction extending to neighbouring particles, and causing them to become attached to the nuclei, although it is not strong enough to make them combine chemically with their substance.

* I met at Edinburgh with a case, remarkable as to its extent, of hygrometric action, assisted a little perhaps by very slight solvent power. Some turf had been well dried by long exposure in a covered place to the atmosphere, but being then submitted to the action of a hydrostatic press, it yielded, *by the mere influence of the pressure*, 54 per cent. of water.

† Fusinieri and Bellani consider the air as forming solid concrete films these cases.—*Giornale di Fisica*, tom. viii. p. 262. 1825.

624. It would appear from many cases of nuclei in solutions, and from the effects of bodies put into atmospheres containing the vapours of water, or camphor, or iodine, &c., as if this attraction were in part elective, partaking in its characters both of the attraction of aggregation and chemical affinity; nor is this inconsistent with, but agreeable to, the idea entertained, that it is the power of particles acting, not upon others with which they can immediately and intimately combine, but upon such as are either more distantly situated with respect to them, or which, from previous condition, physical constitution, or feeble relation, are unable to enter into decided union with them.

625. Then, of all bodies, the gases are those which might be expected to show some *mutual* action whilst *jointly* under the attractive influence of the platina or other solid acting substance. Liquids, such as water, alcohol, &c., are in so dense and comparatively incompressible a state, as to favour no expectation that their particles should approach much closer to each other by the attraction of the body to which they adhere, and yet that attraction must (according to its effects) place their particles as near to those of the solid wetted body as they are to each other, and in many cases it is evident that the former attraction is the stronger. But gases and vapours are bodies competent to suffer very great changes in the relative distances of their particles by external agencies; and where they are in immediate contact with the platina, the approximation of the particles to those of the metal may be very great. In the case of the hygrometric bodies referred to (621.), it is sufficient to reduce the vapour to the fluid state, frequently from atmospheres so rare that without this influence it would be needful to compress them by mechanical force into a bulk not more than $\frac{1}{10}$ or even $\frac{1}{20}$ of their original volume before the vapours would become liquids.

626. Another most important consideration in relation to this action of bodies, and which, as far as I am aware, has not hitherto been noticed, is the condition of elasticity under which the gases are placed against the acting surface. We have but very imperfect notions of the real and intimate conditions of the particles of a body existing in the solid, the liquid, and the gaseous state; but when we speak of the gaseous state

as being due to the mutual repulsions of the particles or of their atmospheres, although we may err in imagining each particle to be a little nucleus to an atmosphere of heat, or electricity, or any other agent, we are still not likely to be in error in considering the elasticity as dependent on *mutuality* of action. Now this mutual relation fails altogether on the side of the gaseous particles next to the platina, and we might be led to expect *à priori* a deficiency of elastic force there to at least one half; for if, as Dalton has shown, the elastic force of the particles of one gas cannot act against the elastic force of the particles of another, the two being as vacua to each other, so is it far less likely that the particles of the platina can exert any influence on those of the gas against it, such as would be exerted by gaseous particles of its own kind.

627. But the diminution of power to one half on the side of the gaseous body towards the metal is only a slight result of what seems to me to flow as a necessary consequence of the known constitution of gases. An atmosphere of one gas or vapour, however dense or compressed, is in effect as a vacuum to another; thus, if a little water were put into a vessel containing a dry gas, as air, of the pressure of one hundred atmospheres, as much vapour of the water would *rise* as if it were in a perfect vacuum. Here the particles of watery vapour appear to have no difficulty in approaching within any distance of the particles of air, being influenced solely by relation to particles of their own kind; and if it be so with respect to a body having the same elastic powers as itself, how much more surely must it be so with particles, like those of the platina, or other limiting body, which at the same time that they have not these elastic powers, are also unlike it in nature. Hence it would seem to result that the particles of hydrogen or any other gas or vapour which are next to the platina, &c., must be in such contact with it as if they were in the liquid state, and therefore almost infinitely closer to it than they are to each other, even though the metal be supposed to exert no attractive influence over them.

628. A third and very important consideration in favour of the mutual action of gases under these circumstances is their perfect miscibility. If fluid bodies capable of combining together are also capable of mixture, *they do combine* when they

are mingled, not waiting for any other determining circumstance; but if two such gases as oxygen and hydrogen are put together, though they are elements having such powerful affinity as to unite naturally under a thousand different circumstances, they do not combine by mere mixture. Still it is evident that, from their perfect association, the particles are in the most favourable state possible for combination, upon the super-vention of any determining cause, such either as the negative action of the platina in suppressing or annihilating, as it were, their elasticity on its side; or the positive action of the metal in condensing them against its surface by an attractive force; or the influence of both together.

629. Although there are not many distinct cases of combination under the influence of forces external to the combining particles, yet there are sufficient to remove any difficulty which might arise on that ground. Sir James Hall found carbonic acid and lime to remain combined under pressure at temperatures at which they would not have remained combined if the pressure had been removed; and I have had occasion to observe a case of direct combination in chlorine*, which being compressed at common temperatures will combine with water, and form a definite crystalline hydrate, incapable either of being formed or of existing if that pressure be removed.

630. The course of events when platina acts upon, and combines oxygen and hydrogen, may be stated, according to these principles, as follows. From the influence of the circumstances mentioned (619. &c.), *i. e.* the deficiency of elastic power and the attraction of the metal for the gases, the latter, when they are in association with the former, are so far condensed as to be brought within the action of their mutual affinities at the existing temperature; the deficiency of elastic power, not merely subjecting them more closely to the attractive influence of the metal, but also bringing them into a more favourable state for union, by abstracting a part of that power (upon which depends their elasticity,) which elsewhere in the mass of gases is opposing their combination. The consequence of their combination is the production of the vapour of water and an elevation of temperature. But as the attraction of the platina for the water formed is not greater than for the gases, if so great,

* Philosophical Transactions, 1823, p. 161.

(for the metal is scarcely hygrometric,) the vapour is quickly diffused through the remaining gases; fresh portions of the latter, therefore, come into juxtaposition with the metal, combine, and the fresh vapour formed is also diffused, allowing new portions of gas to be acted upon. In this way the process advances, but is accelerated by the evolution of heat, which is known by experiment to facilitate the combination in proportion to its intensity, and the temperature is thus gradually exalted until ignition results.

631. The dissipation of the vapour produced at the surface of the platina, and the contact of fresh oxygen and hydrogen with the metal, form no difficulty in this explanation. The platina is not considered as causing the combination of any particles with itself, but only associating them closely around it; and the compressed particles are as free to move from the platina, being replaced by other particles, as a portion of dense air upon the surface of the globe, or at the bottom of a deep mine, is free to move by the slightest impulse, into the upper and rarer parts of the atmosphere.

632. It can hardly be necessary to give any reasons why platina does not show this effect under ordinary circumstances. It is then not sufficiently clean (617.), and the gases are prevented from touching it, and suffering that degree of effect which is needful to commence their combination at common temperatures, and which they can only experience at its surface. In fact, the very power which causes the combination of oxygen and hydrogen, is competent, under the usual casual exposure of platina, to condense extraneous matters upon its surface, which soiling it, take away for the time its power of combining oxygen and hydrogen, by preventing their contact with it (598.).

633. Clean platina, by which I mean such as has been made the positive pole of a pile (570.), or has been treated with acid (605.), and has then been put into distilled water for twelve or fifteen minutes, has a *peculiar friction* when one piece is rubbed against another. It wets freely with pure water, even after it has been shaken and dried by the heat of a spirit lamp; and if made the pole of a voltaic pile in a dilute acid, it evolves minute bubbles from every part of its surface. But platina in its common state wants that peculiar friction: it will not wet

freely with water as the clean platina does; and when made the positive pole of a pile, it for a time gives off large bubbles, which seem to cling or adhere to the metal, and are evolved at distinct and separate points of the surface. These appearances and effects, as well as its want of power on oxygen and hydrogen, are the consequences, and the indications, of a soiled surface.

634. I found also that platina plates which had been cleaned perfectly soon became soiled by mere exposure to the air; for after twenty-four hours they no longer moistened freely with water, but the fluid ran up into portions, leaving part of the surface bare, whilst other plates which had been retained in water for the same time, when they were dried (580.) did moisten, and gave the other indications of a clean surface.

635. Nor was this the case with platina or metals only, but also with earthy bodies. Rock crystal and obsidian would not wet freely upon the surface, but being moistened with strong oil of vitriol, then washed, and left in distilled water to remove all the acid, they did freely become moistened, whether they were previously dry or whether they were left wet; but being dried and left exposed to the air for twenty-four hours, their surface became so soiled that water would not then adhere freely to it, but ran up into partial portions. Wiping with a cloth (even the cleanest) was still worse than exposure to air; the surface either of the minerals or metals immediately became as if it were slightly greasy. The floating upon water of small particles of metals under ordinary circumstances is a consequence of this kind of soiled surface. The extreme difficulty of cleaning the surface of mercury when it has once been soiled or greased, is due to the same cause.

636. The same reasons explain why the power of the platina plates in some circumstances soon disappear, and especially upon use: MM. Dulong and Thenard have observed the same effect with the spongy metal*, as indeed have all those who have used Dobereiner's instantaneous light machines. If left in the air, if put into ordinary distilled water, if made to act upon ordinary oxygen and hydrogen, they can still find in all these cases *that* minute portion of impurity which, when once in contact with the surface of the platina, is retained there, and

* Annales de Chimie, tom. xxiv. p. 386.

is sufficient to prevent its full action upon oxygen and hydrogen at common temperatures: a slight elevation of temperature is again sufficient to compensate this effect, and cause combination.

637. No state of a solid body can be conceived more favourable for the production of the effect than that which is possessed by platina obtained from the ammonio-muriate by heat. Its surface is most extensive and pure, yet very accessible to the gases brought in contact with it: if placed in impurity, the interior, as Thenard and Dulong have observed, is preserved clean by the exterior; and as regards temperature, it is so bad a conductor of heat, because of its divided condition, that almost all which is evolved by the combination of the first portions of gas is retained within the mass, exalting the tendency of the succeeding portions to combine.

638. I have now to notice some very extraordinary interferences with this phenomenon, dependent, not upon the nature or condition of the metal or other acting solid, but upon the presence of certain substances mingled with the gases acted upon; and as I shall have occasion to speak frequently of a mixture of oxygen and hydrogen, I wish it always to be understood that I mean a mixture composed of one volume oxygen to two volumes of hydrogen, being the proportions that form water. Unless otherwise expressed, the hydrogen was always that obtained by the action of dilute sulphuric acid on pure zinc, and the oxygen that obtained by the action of heat from the chlorate of potassa.

639. Mixtures of oxygen and hydrogen with *air*, containing one fourth, one half, and even two thirds of the latter, being introduced with prepared platina plates (570. 605.), into tubes, were acted upon almost as well as if no air were present: the retardation was far less than might have been expected from the mere dilution and consequent obstruction to the contact of the gases with the plates. In two hours and a half nearly all the oxygen and hydrogen introduced as mixture was gone.

640. But when similar experiments were made with *olefiant gas* (the platina plates having been made the positive poles of a voltaic pile (570.) in acid), very different results occurred. A mixture was made of 29.2 volumes hydrogen and 14.6 volumes

oxygen, being the proportions for water; and to this was added another mixture of 3 volumes oxygen and one volume olefiant gas, so that the olefiant gas formed but $\frac{1}{8}$ th part of the whole; yet in this mixture the platina plate would not act in forty-five hours. The failure was not for want of any power in the plate, for when after that time it was taken out of this mixture and put into one of oxygen and hydrogen, it immediately acted, and in seven minutes caused explosion of the gas. This result was obtained several times, and when larger proportions of olefiant gas were used, the action seemed still more hopeless.

641. A mixture of forty-nine volumes oxygen and hydrogen (638.) with one volume of olefiant gas had a well-prepared platina plate introduced. The diminution of gas was scarcely sensible at the end of two hours, during which it was watched; but on examination twenty-four hours afterwards, the tube was found blown to pieces. The action, therefore, though it had been very much retarded, had occurred at last, and risen to a maximum.

642. With a mixture of ninety-nine volumes of oxygen and hydrogen (638.) with one of olefiant gas, a feeble action was evident at the end of fifty minutes; it went on accelerating (630.) until the eighty-fifth minute, and then became so intense that the gas exploded. Here also the retarding effect of the olefiant gas was very beautifully illustrated.

643. Plates prepared by alkali and acid (605.) produced effects corresponding to those just described.

644. It is perfectly clear from these experiments, that *olefiant gas*, even in small quantities, has a very remarkable influence in preventing the combination of oxygen and hydrogen under these circumstances, and yet without at all injuring or affecting the power of the platina.

645. Another striking illustration of similar interference may be shown in *carbonic oxide*; especially if contrasted with *carbonic acid*. A mixture of one volume oxygen and hydrogen (638.) with four volumes of carbonic acid was affected at once by a platina plate prepared with acid, &c. (605.), and in one hour and a quarter nearly all the oxygen and hydrogen was gone. Mixtures containing less carbonic acid were still more readily affected.

646. But when carbonic oxide was substituted for the car-

bonic acid, not the slightest effect of combination was produced; and when the carbonic oxide was only one eighth of the whole volume, no action occurred in forty and fifty hours. Yet the plates had not lost their power; for being taken out and put into pure oxygen and hydrogen, they acted well and at once.

647. Two volumes of carbonic oxide and one of oxygen were mingled with nine volumes of oxygen and hydrogen (638). This mixture was not affected by a plate which had been made positive in acid, though it remained in it fifteen hours. But when to the same volumes of carbonic oxide and oxygen were added thirty-three volumes of oxygen and hydrogen, the carbonic oxide being then only $\frac{1}{18}$ th part of the whole, the plate acted, slowly at first, and at the end of forty-two minutes the gases exploded.

648. These experiments were extended to various gases and vapours, the general results of which may be given as follow. Oxygen, hydrogen, nitrogen, and nitrous oxide, when used to dilute the mixture of oxygen and hydrogen, did not prevent the action of the plates even when they made four-fifths of the whole volume of gas acted upon. Nor was the retardation so great in any case as might have been expected from the mere dilution of the oxygen and hydrogen, and the consequent mechanical obstruction to its contact with the platina. The order in which carbonic acid and these substances seemed to stand was as follows, the first interfering least with the action; *nitrous oxide, hydrogen, carbonic acid, nitrogen, oxygen*: but it is possible the plates were not equally well prepared in all the cases, and that other circumstances also were unequal; consequently more numerous experiments would be required to establish the order accurately.

649. As to cases of *retardation*, the powers of olciant gas and carbonic oxide have been already described. Mixtures of oxygen and hydrogen, containing from $\frac{1}{16}$ th to $\frac{1}{20}$ th of sulphuretted hydrogen or phosphuretted hydrogen, seemed to show a little action at first, but were not further affected by the prepared plates, though in contact with them for seventy hours. When the plates were removed they had lost all power over pure oxygen and hydrogen, and the interference of these gases was therefore of a different nature from that of the two former, having permanently affected the plate.

650. A small piece of cork was dipped in sulphuret of carbon and passed up through water into a tube containing oxygen and hydrogen (638.), so as to diffuse a portion of its vapour through the gases. A plate being introduced appeared at first to act a little, but after sixty-one hours the diminution was very small. Upon putting the same plate into a pure mixture of oxygen and hydrogen, it acted at once and powerfully, having apparently suffered no diminution of its force.

651. A little vapour of ether being mixed with the oxygen and hydrogen retarded the action of the plate, but did not prevent it altogether. A little of the vapour of the condensed oil-gas liquor* retarded the action still more, but not nearly so much as an equal volume of olefiant gas would have done. In both these cases it was the original oxygen and hydrogen which combined together, the ether and the oil-gas vapour remaining unaffected, and in both cases the plates retained the power of acting on fresh oxygen and hydrogen.

652. Spongy platina was then used in place of the plates, and jets of hydrogen mingled with the different gases thrown against it in air. The results were exactly of the same kind, although presented occasionally in a more imposing form. Thus, mixtures of one volume of olefiant gas or carbonic oxide with three of hydrogen could not heat the spongy platina when the experiments were commenced at common temperatures; but a mixture of equal volumes of nitrogen and hydrogen acted very well, causing ignition. With carbonic acid the results were still more striking. A mixture of three volumes of that gas with one of hydrogen caused *ignition* of the platina, yet that mixture would not continue to burn from the jet when attempts were made to light it by a taper. A mixture even of *seven* volumes of carbonic acid and *one* of hydrogen will thus cause the ignition of cold spongy platina, and yet, as if to supply a contrast, than which none can be greater, *it cannot burn at a taper*, but causes the extinction of the latter. On the other hand, the mixtures of carbonic oxide or olefiant gas, which can do nothing with the platina, are *inflamed* by the taper, burning well.

653. Hydrogen mingled with the vapour of ether or oil-gas liquor causes the ignition of the spongy platina. The mixture with oil-gas burns with a flame far brighter than that of the

* Philosophical Transactions, 1825, p. 440.

mixture of hydrogen and olefiant gas already referred to, so that it would appear that the retarding action of the hydro-carbons is not at all in proportion merely to the quantity of carbon present.

654. In connexion with these interferences, I must state, that hydrogen itself, prepared from steam passed over ignited iron, was found when mingled with oxygen to resist the action of platina. It had stood over water seven days, and had lost all fetid smell; but a jet of it would not cause the ignition of spongy platina, commencing at common temperatures; nor would it combine with oxygen in a tube either under the influence of a prepared plate or of spongy platina. A mixture of one volume of this gas with three of pure hydrogen, and the due proportion of oxygen, was not affected by plates after fifty hours. I am inclined to refer the effect to carbonic oxide present in the gas, but have not had time to verify the suspicion. The power of the plates was not destroyed (640. 646.).

655. Such are the general facts of these remarkable interferences. Whether the effect produced by such small quantities of certain gases depends upon any direct action which they may exert upon the particles of oxygen and hydrogen, by which the latter are rendered less inclined to combine, or whether it depends upon their modifying the action of the plate temporarily (for they produce no real change on it), by investing it through the agency of a stronger attraction than that of the hydrogen, or otherwise, remains to be decided by more extended experiments.

656. The theory of action which I have given for the original phenomena appears to me quite sufficient to account for all the effects by reference to known properties, and dispenses with the assumption of any new power of matter. I have pursued this subject at some length, as one of great consequence, because I am convinced that the superficial actions of matter, whether between two bodies, or of one piece of the same body, and the actions of particles not directly or strongly in combination, are becoming daily more and more important to our theories of chemical as well as mechanical philosophy*. In

* As a curious illustration of the influence of mechanical forces over chemical affinity, I will quote the refusal of certain substances to effloresce when

all ordinary cases of combustion it is evident that an action of the kind considered, occurring upon the surface of the carbon in the fire, and also in the bright part of a flame, must have great influence over the combinations there taking place.

657. The condition of elasticity upon the exterior of the gaseous or vaporous mass already referred to (626. 627.), must be connected directly with the action of solid bodies, as nuclei, on vapours, causing condensation upon them in preference to any condensation in the vapours themselves; and in the well-known effect of nuclei on solutions a similar condition may have existence (623.), for an analogy in condition exists between the parts of a body in solution, and those of a body in the vaporous or gaseous state. This thought leads us to the consideration of what are the respective conditions at the surfaces of contact of two portions of the same substance at the same temperature, one in the solid or liquid, and the other in the vaporous state; as, for instance, steam and water. It would seem that the particles of vapour next to the particles of liquid are in a different relation to the latter to what they would be with respect to any other liquid or solid substance; as, for instance, mercury or platina, if they were made to replace the water, *i. e.* if the view of independent action which I have taken (626. 627.) as a consequence of Dalton's principles, be correct. It would also seem that the mutual relation of similar particles, and the indifference of dissimilar particles which Dalton has established as a matter of fact amongst gases and vapours, extends to a certain degree amongst solids and fluids, that is, when they are in relation by contact with vapours, either of their own substance or of other bodies. But though I view these points as of great importance with respect to the relations existing between different substances and their physical constitution in the solid,

their surfaces are perfect, which yield immediately upon the surface being broken. If crystals of carbonate of soda, or phosphate of soda, or sulphate of soda, having no part of their surfaces broken, be preserved from external violence, they will not effloresce. I have thus retained crystals of carbonate of soda perfectly transparent and unchanged from September 1827 to January 1833; and crystals of sulphate of soda from May 1832 to the present time, November 1833. If any part of the surface were scratched or broken, then efflorescence began at that part, and covered the whole. The crystals were merely placed in evaporating basins and covered with paper.

liquid, or gaseous state, I have not sufficiently considered them to venture any strong opinions or statements here*.

658. There are numerous well-known cases, in which substances, such as oxygen and hydrogen, act readily in their *nascent* state, and produce chemical changes which they are not able to effect if once they have assumed the gaseous condition. Such instances are very common at the poles of the voltaic pile, and are, I think, easily accounted for, if it be considered that at the moment of separation of any such particle it is entirely surrounded by other particles of a *different* kind with which it is in close contact, and has not yet assumed those relations and conditions which it has in its fully developed state, and which it can only assume by association with other particles of its own kind. For, at the moment, its elasticity is absent, and it is in the same relation to particles with which it is in contact, and for which it has an affinity, as the particles of oxygen and hydrogen are to each other on the surface of clean platina (626. 627.).

659. The singular effects of retardation produced by very small quantities of some gases, and not by large quantities of others (640. 645. 652.), if dependent upon any relation of the added gas to the surface of the solid, will then probably be found immediately connected with the curious phenomena which are presented by different gases when passing through narrow tubes at low pressures, which I observed many years ago †; and this action of surfaces must, I think, influence the highly interesting phenomena of the diffusion of gases, at least in the form in which it has been experimented upon by Mr. Graham in 1829 and 1831 ‡, and also by Dr. Mitchell of Philadelphia § in 1830. It seems very probable that if such a substance as spongy platina were used, another law for the diffusion of gases under the circumstances would come out than that obtained by the use of plaster of Paris.

* In reference to this paragraph and also 626, see a correction by Dr. C. Henry, in his valuable paper on this curious subject. *Philosophical Magazine*, 1835, vol. vi. p. 365.—*Dec.* 1838.

† *Quarterly Journal of Science*, 1819, vol. vii. p. 106.

‡ *Quarterly Journal of Science*, vol. xxviii. p. 74., and *Edinburgh Transactions*, 1831.

§ *Journal of the Royal Institution for 1831*, p. 101.

660. I intended to have followed this section by one on the secondary piles of Ritter, and the peculiar properties of the poles of the pile, or of metals through which electricity has passed, which have been observed by Ritter, Van Marum, Yelin, De la Rive, Marianini, Berzelius, and others. It appears to me that all these phenomena bear a satisfactory explanation on known principles, connected with the investigation just terminated, and do not require the assumption of any new state or new property. But as the experiments advanced, especially those of Marianini, require very careful repetition and examination, the necessity of pursuing the subject of electro-chemical decomposition obliges me for a time to defer the researches to which I have just referred.

Royal Institution,
November 30, 1833.

SEVENTH SERIES.

§ 11. *On Electro-chemical Decomposition, continued**. ¶ iv. *On some general conditions of Electro-decomposition.* ¶ v. *On a new Measurer of Volta-electricity.* ¶ vi. *On the primary or secondary character of bodies evolved in Electro-decomposition.* ¶ vii. *On the definite nature and extent of Electro-chemical Decompositions.* § 13. *On the absolute quantity of Electricity associated with the particles or atoms of Matter.*

Received January 9.—Read January 23, February 6 and 13, 1834.

Preliminary.

661. THE theory which I believe to be a true expression of the facts of electro-chemical decomposition, and which I have therefore detailed in a former series of these Researches, is so much at variance with those previously advanced, that I find the greatest difficulty in stating results, as I think, correctly, whilst limited to the use of terms which are current with a certain accepted meaning. Of this kind is the term *pole*, with its prefixes of positive and negative, and the attached ideas of attraction and repulsion. The general phraseology is that the positive pole *attracts* oxygen, acids, &c., or more cautiously, that it *determines* their evolution upon its surface; and that the negative pole acts in an equal manner upon hydrogen, combustibles, metals, and bases. According to my view, the determining force is *not* at the poles, but *within* the body under decomposition; and the oxygen and acids are rendered at the *negative* extremity of that body, whilst hydrogen, metals, &c., are evolved at the *positive* extremity (518. 524.).

662. To avoid, therefore, confusion and circumlocution, and for the sake of greater precision of expression than I can otherwise obtain, I have deliberately considered the subject with two friends, and with their assistance and concurrence in framing

* Refer to the note after 1047, Series VIII.—Dec. 1833.

them, I purpose henceforward using certain other terms, which I will now define. The *poles*, as they are usually called, are only the doors or ways by which the electric current passes into and out of the decomposing body (556.); and they of course, when in contact with that body, are the limits of its extent in the direction of the current. The term has been generally applied to the metal surfaces in contact with the decomposing substance; but whether philosophers generally would also apply it to the surfaces of air (465. 471.) and water (493.), against which I have effected electro-chemical decomposition, is subject to doubt. In place of the term pole, I propose using that of *Electrode**, and I mean thereby that substance, or rather surface, whether of air, water, metal, or any other body, which bounds the extent of the decomposing matter in the direction of the electric current.

663. The surfaces at which, according to common phrasology, the electric current enters and leaves a decomposing body, are most important places of action, and require to be distinguished apart from the poles, with which they are mostly, and the electrodes, with which they are always, in contact. Wishing for a natural standard of electric direction to which I might refer these, expressive of their difference and at the same time free from all theory, I have thought it might be found in the earth. If the magnetism of the earth be due to electric currents passing round it, the latter must be in a constant direction, which, according to present usage of speech, would be from east to west, or, which will strengthen this help to the memory, that in which the sun appears to move. If in any case of electro-decomposition we consider the decomposing body as placed so that the current passing through it shall be in the same direction, and parallel to that supposed to exist in the earth, then the surfaces at which the electricity is passing into and out of the substance would have an invariable reference, and exhibit constantly the same relations of powers. Upon this notion we purpose calling that towards the east the *anode* †, and that towards the west the *cathode* ‡; and whatever changes may take place in our views of the nature of electricity and electrical

* ἤλεκτρον, and ὁδὸς a way.

† ἀνω upwards, and ὁδὸς a way; the way which the sun rises.

‡ κατὰ downwards, and ὁδὸς a way; the way which the sun sets.

action, as they must affect the *natural standard* referred to, in the same direction, and to an equal amount with any decomposing substances to which these terms may at any time be applied, there seems no reason to expect that they will lead to confusion, or tend in any way to support false views. The *anode* is therefore that surface at which the electric current according to our present expression, enters: it is the *negative* extremity of the decomposing body; is where oxygen, chlorine, acids, &c., are evolved; and is against or opposite the positive electrode. The *cathode* is that surface at which the current leaves the decomposing body; and is its *positive* extremity; the combustible bodies, metals, alkalies, and bases, are evolved there, and it is in contact with the negative electrode.

664. I shall have occasion in these Researches, also, to class bodies together according to certain relations derived from their electrical actions (822.); and wishing to express those relations without at the same time involving the expression of any hypothetical views, I intend using the following names and terms. Many bodies are decomposed directly by the electric current, their elements being set free: these I propose to call *electrolytes**. Water, therefore, is an electrolyte. The bodies which, like nitric or sulphuric acids, are decomposed in a secondary manner (752. 757.), are not included under this term. Then for *electro-chemically decomposed*, I shall often use the term *electrolyzed*, derived in the same way, and implying that the body spoken of is separated into its components under the influence of electricity: it is analogous in its sense and sound to *analyze*, which is derived in a similar manner. The term *electrolytical* will be understood at once: muriatic acid is electrolytical, boracic acid is not.

665. Finally, I require a term to express those bodies which can pass to the *electrodes*, or, as they are usually called, the poles. Substances are frequently spoken of as being *electro-negative*, or *electro-positive*, according as they go under the supposed influence of a direct attraction to the positive or negative pole. But these terms are much too significant for the use to which I should have to put them; for though the meanings are perhaps right, they are only hypothetical, and may be wrong; and then, through a very imperceptible, but still very dangerous,

* ἤλεκτρον, and λύω, *solvo*. N. Electrolyte, V. Electrolyze.

because continual, influence, they do great injury to science, by contracting and limiting the habitual views of those engaged in pursuing it. I propose to distinguish such bodies by calling those *anions** which go to the *anode* of the decomposing body; and those passing to the *cathode*, *cations*†; and when I have occasion to speak of these together, I shall call them *ions*. Thus, the chloride of lead is an *electrolyte*, and when *electrolyzed* evolves the two *ions*, chlorine and lead, the former being an *anion*, and the latter a *cation*.

666. These terms being once well defined, will, I hope, in their use enable me to avoid much periphrasis and ambiguity of expression. I do not mean to press them into service more frequently than will be required, for I am fully aware that names are one thing and science another ‡.

667. It will be well understood that I am giving no opinion respecting the nature of the electric current now, beyond what I have done on former occasions (283. 517.); and that though I speak of the current as proceeding from the parts which are positive to those which are negative (663.), it is merely in accordance with the conventional, though in some degree tacit, agreement entered into by scientific men, that they may have a constant, certain, and definite means of referring to the direction of the forces of that current.

¶ iv. On some general conditions of electro-chemical Decomposition.

669. From the period when electro-chemical decomposition was first effected to the present time, it has been a remark, that those elements which in the ordinary phenomena of chemical affinity, were the most directly opposed to each other, and combined with the greatest attractive force, were those which were the most readily evolved at the opposite extremities of the decomposing bodies (549.).

670. If this result was evident when water was supposed to be essential to, and was present, in almost every case of such

* ἀνωὶν that which goes up. (Neuter participle.)

† κατωὶν that which goes down

‡ Since this paper was read, I have changed some of the terms which were first proposed, that I might employ only such as were at the same time simple in their nature, clear in their reference, and from hypothesis.

decomposition (472.), it is far more evident now that it has been shown and proved that water is not necessarily concerned in the phenomena (474.), and that other bodies much surpass it in some of the effects supposed to be peculiar to that substance.

671. Water, from its constitution and the nature of its elements, and from its frequent presence in cases of electrolytic action, has hitherto stood foremost in this respect. Though a compound formed by very powerful affinity, it yields up its elements under the influence of a very feeble electric current; and it is doubtful whether a case of electrolyzation can occur, where, being present, it is not resolved into its first principles.

672. The various oxides, chlorides, iodides, and salts, which I have shown are decomposable by the electric current when in the liquid state, under the same general law with water (402.), illustrate in an equally striking manner the activity, in such decompositions, of elements directly and powerfully opposed to each other by their chemical relations.

673. On the other hand, bodies dependent on weak affinities very rarely give way. Take, for instance, glasses: many of those formed of silica, lime, alkali, and oxide of lead, may be considered as little more than solutions of substances one in another*. If bottle-glass be fused, and subjected to the voltaic pile, it does not appear to be at all decomposed (408.) If flint glass, which contains substances more directly opposed, be operated upon, it suffers some decomposition; and if borate of lead glass, which is a definite chemical compound, be experimented with, it readily yields up its elements (408.).

674. But the result which is found to be so striking in the instances quoted is not at all borne out by reference to other cases where a similar consequence might have been expected. It may be said, that my own theory of electro-chemical decomposition would lead to the expectation that all compound bodies should give way under the influence of the electric current with a facility proportionate to the strength of the affinity by which their elements, either proximate or ultimate, are combined. I am not sure that that follows as a consequence of the theory; but if the objection is supposed to be one presented by the facts, I have no doubt it will be removed when we obtain a more inti-

* Philosophical Transactions, 1830, p. 49.

mate acquaintance with, and precise idea of, the nature of chemical affinity and the mode of action of an electric current over it (518. 524.) : besides which it is just as directly opposed to any other theory of electro-chemical decomposition as the one I have propounded ; for if it be admitted, as is generally the case, that the more directly bodies are opposed to each other in their attractive forces, the more powerfully do they combine, then the objection applies with equal force to any of the theories of electrolyzation which have been considered, and is an addition to those which I have taken against them.

675. Amongst powerful compounds which are not decomposed, boracic acid stands prominent (408.). Then again, the iodide of sulphur, and the chlorides of sulphur, phosphorus, and carbon, are not decomposable under common circumstances, though their elements are of a nature which would lead to a contrary expectation. Chloride of antimony (402. 690.), the hydrocarbons, acetic acid, ammonia, and many other bodies undecomposable by the voltaic pile, would seem to be formed by an affinity sufficiently strong to indicate that the elements were so far contrasted in their nature as to sanction the expectation that the pile would separate them, especially as in some cases of mere solution (530. 544.), where the affinity must by comparison be very weak, separation takes place*.

676. It must not be forgotten, however, that much of this difficulty, and perhaps the whole, may depend upon the absence of conducting power, which, preventing the transmission of the current, prevents of course the effects due to it. All known compounds being non-conductors when solid, but conductors when liquid, are decomposed, with *perhaps* the single exception at present known of periodide of mercury (679. 691.) †; and even water itself, which so easily yields up its elements when the current passes, if rendered quite pure, scarcely suffers change, because it then becomes a very bad conductor.

677. If it should hereafter be proved that the want of decomposition in those cases where, from chemical considerations, it might be so strongly expected (669. 672. 674.), is due to the

* With regard to solution, I have met with some reasons for supposing that it will probably disappear as a cause of transference, and intend resuming the consideration at a convenient opportunity.

† See now, 1340, 1341.—*Dec.* 1838.

absence or deficiency of conducting power, it would also at the same time be proved that decomposition *depends* upon conduction, and not the latter upon the former (413.); and in water this seems to be very nearly decided. On the other hand, the conclusion is almost irresistible, that in electrolytes the power of transmitting the electricity across the substance is *dependent* upon their capability of suffering decomposition; taking place only whilst they are decomposing, and being proportionate to the quantity of elements separated (821.). I may not, however, stop to discuss this point experimentally at present.

678. When a compound contains such elements as are known to pass towards the opposite extremities of the voltaic pile, still the proportions in which they are present appear to be intimately connected with capability in the compound of suffering or resisting decomposition. Thus, the protochloride of tin readily conducts, and is decomposed (402.), but the perchloride neither conducts nor is decomposed (406.). The protiodide of tin is decomposed when fluid (402.); the periodide is not (405.). The periodide of mercury when fused is not decomposed (691.), even though it does conduct. I was unable to contrast it with the protiodide, the latter being converted into mercury and periodide by heat.

679. These important differences induced me to look more closely to certain binary compounds, with a view of ascertaining whether a *law* regulating the *decomposability* according to some *relation of the proportionals or equivalents* of the elements, could be discovered. The proto compounds only, amongst those just referred to, were decomposable; and on referring to the substances quoted to illustrate the force and generality of the law of conduction and decomposition which I discovered (402.), it will be found that all the oxides, chlorides, and iodides subject to it, except the chloride of antimony and the periodide of mercury, (to which may now perhaps be added corrosive sublimate,) are also decomposable, whilst many per compounds of the same elements, not subject to the law, were not so (405. 406.).

680. The substances which appeared to form the strongest exceptions to this general result were such bodies as the sulphuric, phosphoric, nitric, arsenic, and other acids.

681. On experimenting with sulphuric acid, I found no rea-

son to believe that it was by itself a conductor of, or decomposable by, electricity, although I had previously been of that opinion (552.). When very strong it is a much worse conductor than if diluted*. If then subjected to the action of a powerful battery, oxygen appears at the *anode*, or positive electrode, although much is absorbed (728.), and hydrogen and sulphur appear at the *cathode*, or negative electrode. Now the hydrogen has with me always been pure, not sulphuretted, and has been deficient in proportion to the sulphur present, so that it is evident that when decomposition occurred water must have been decomposed. I endeavoured to make the experiment with anhydrous sulphuric acid; and it appeared to me that, when fused, such acid was not a conductor, nor decomposed; but I had not enough of the dry acid in my possession to allow me to decide the point satisfactorily. My belief is, that when sulphur appears during the action of the pile on sulphuric acid, it is the result of a secondary action, and that the acid itself is not electrolyzable (757.).

682. Phosphoric acid is, I believe, also in the same condition; but I have found it impossible to decide the point, because of the difficulty of operating on fused anhydrous phosphoric acid. Phosphoric acid which has once obtained water cannot be deprived of it by heat alone. When heated, the hydrated acid volatilizes. Upon subjecting phosphoric acid, fused upon the ring end of a wire (401.), to the action of the voltaic apparatus, it conducted, and was decomposed; but gas, which I believe to be hydrogen, was always evolved at the negative electrode, and the wire was not affected as would have happened had phosphorus been separated. Gas was also evolved at the positive electrode. From all the facts, I conclude it was the water and not the acid which was decomposed.

683. *Arsenic acid.* This substance conducted, and was decomposed; but it contained water, and I was unable at the time to press the investigation so as to ascertain whether a fusible anhydrous arsenic acid could be obtained. It forms, therefore, at present no exception to the general result.

684. Nitrous acid, obtained by distilling nitrate of lead, and keeping it in contact with strong sulphuric acid, was found to conduct and decompose slowly. But on examination there were

* De la Rive.

strong reasons for believing that water was present, and that the decomposition and conduction depended upon it. I endeavoured to prepare a perfectly anhydrous portion, but could not spare the time required to procure an unexceptionable result.

685. Nitric acid is a substance which I believe is not decomposed directly by the electric current. As I want the facts in illustration of the distinction existing between primary and secondary decomposition, I will merely refer to them in this place (752.).

686. That these mineral acids should confer facility of conduction and decomposition on water, is no proof that they are competent to favour and suffer these actions in themselves. Boracic acid does the same thing, though not decomposable. M. de la Rive has pointed out that chlorine has this power also; but being to us an elementary substance, it cannot be due to its capability of suffering decomposition.

687. *Chloride of sulphur* does not conduct, nor is it decomposed. It consists of single proportionals of its elements, but is not on that account an exception to the rule (679.), which does not affirm that *all* compounds of single proportionals of elements are decomposable, but that such as are decomposable are so constituted.

688. *Protochloride of phosphorus* does not conduct nor become decomposed.

689. *Protochloride of carbon* does not conduct nor suffer decomposition. In association with this substance, I submitted the *hydro-chloride of carbon* from olefiant gas and chlorine to the action of the electric current; but it also refused to conduct or yield up its elements.

690. With regard to the exceptions (679.), upon closer examination, some of them disappear. Chloride of antimony (a compound of one proportional of antimony and one and a half of chlorine) of recent preparation was put into a tube (fig. 68.) (789.), and submitted when fused to the action of the current, the positive electrode being of plumbago. No electricity passed, and no appearance of decomposition was visible at first; but when the positive and negative electrodes were brought very near each other in the chloride, then a feeble action occurred and a feeble current passed. The effect altogether was so

small (although quite amenable to the law before given (394.)), and so unlike the decomposition and conduction occurring in all the other cases, that I attribute it to the presence of a minute quantity of water, (for which this and many other chlorides have strong attractions, producing hydrated chlorides,) or perhaps of a true protochloride consisting of single proportionals (695. 796.).

691. *Periodide of mercury* being examined in the same manner, was found most distinctly to insulate whilst solid, but conduct when fluid, according to the law of *liquido-conduction* (402.); but there was no appearance of decomposition. No iodine appeared at the *anode*, nor mercury or other substance at the *cathode*. The case is, therefore, no exception to the rule, that only compounds of single proportionals are decomposable; but it is an exception, and I think the only one, to the statement, that all bodies subject to the law of *liquido-conduction* are decomposable. I incline, however, to believe, that a portion of protiodide of mercury is retained dissolved in the periodide, and that to its slow decomposition the feeble conducting power is due. Periodide would be formed, as a secondary result, at the *anode*; and the mercury at the *cathode* would also form, as a secondary result, protiodide. Both these bodies would mingle with the fluid mass, and thus no final separation appear, notwithstanding the continued decomposition.

692. When *perchloride of mercury* was subjected to the voltaic current, it did not conduct in the solid state, but it did conduct when fluid. I think, also, that in the latter case it was decomposed; but there are many interfering circumstances which require examination before a positive conclusion can be drawn*.

693. When the ordinary protoxide of antimony is subjected to the voltaic current in a fused state, it also is decomposed, although the effect from other causes soon ceases (402. 801.). This oxide consists of one proportional of antimony and one and a half of oxygen, and is therefore an exception to the general law assumed. But in working with this oxide and the chloride, I observed facts which lead me to doubt whether the compounds usually called the protoxide and the protochloride do not often contain other compounds, consisting of single pro-

* With regard to perchloride and periodide of mercury, see now 1340, 1341. *D ec.* 1838.

portions, which are the true proto compounds, and which, in the case of the oxide, might give rise to the decomposition above described.

694. The ordinary sulphuret of antimony is considered as being the compound with the smallest quantity of sulphur, and analogous in its proportions to the ordinary protoxide. But I find that if it be fused with metallic antimony, a new sulphuret is formed, containing much more of the metal than the former, and separating distinctly, when fused, both from the pure metal on the one hand, and the ordinary gray sulphuret on the other. In some rough experiments, the metal thus taken up by the ordinary sulphuret of antimony was equal to half the proportion of that previously in the sulphuret, in which case the new sulphuret would consist of *single* proportionals.

695. When this new sulphuret was dissolved in muriatic acid, although a little antimony separated, yet it appeared to me that a true protochloride, consisting of *single* proportionals, was formed, and from that, by alkalies, &c., a true protoxide, consisting also of *single* proportionals, was obtainable. But I could not stop to ascertain this matter strictly by analysis.

696. I believe, however, that there is such an oxide; that it is often present in variable proportions in what is commonly called protoxide, throwing uncertainty upon the results of its analysis, and causing the electrolytic decomposition above described*.

697. Upon the whole, it appears probable that all those binary compounds of elementary bodies which are capable of being electrolyzed when fluid, but not whilst solid, according to the law of liquido-conduction (394.), consist of single proportionals of their elementary principles; and it may be because of their departure from this simplicity of composition, that boracic acid, ammonia, perchlorides, periodides, and many other direct compounds of elements, are indecomposable.

698. With regard to salts and combinations of compound bodies, the same simple relation does not appear to hold good. I could not decide this by bisulphates of the alkalies, for as long

* In relation to this and the three preceding paragraphs, and also 801, see Berzelius's correction of the nature of the supposed new sulphuret and oxide, *Phil. Mag.* 1836, vol. viii. 476: and for the probable explanation of the effects obtained with the protoxide, refer to 1340, 1341.—*Dec.* 1838.

as the second proportion of acid remained, water was retained with it. The fused salts conducted, and were decomposed; but hydrogen always appeared at the negative electrode.

699. A biphosphate of soda was prepared by heating, and ultimately fusing, the ammonia-phosphate of soda. In this case the fused bisalt conducted, and was decomposed; but a little gas appeared at the negative electrode; and though I believe the salt itself was electrolyzed, I am not quite satisfied that water was entirely absent.

700. Then a baborate of soda was prepared; and this, I think, is an unobjectionable case. The salt, when fused, conducted, and was decomposed, and gas appeared at both electrodes: even when the boracic acid was increased to three proportionals, the same effect took place.

701. Hence this class of compound combinations does not seem to be subject to the same simple law as the former class of binary combinations. Whether we may find reason to consider them as mere solutions of the compound of single proportionals in the excess of acid, is a matter which, with some apparent exceptions occurring amongst the sulphurets, must be left for decision by future examination.

702. In any investigation of these points, great care must be taken to exclude water; for if present, secondary effects are so frequently produced as often seemingly to indicate an electro-decomposition of substances, when no true result of the kind has occurred (742, &c.).

703. It is evident that all the cases in which decomposition *does not occur*, may depend upon the want of conduction (677. 413.); but that does not at all lessen the interest excited by seeing the great difference of effect due to a change, not in the nature of the elements, but merely in their proportions; especially in any attempt which may be made to elucidate and expound the beautiful theory put forth by Sir Humphry Davy*, and illustrated by Berzelius and other eminent philosophers, that ordinary chemical affinity is a mere result of the electrical attractions of the particles of matter.

¶ v. *On a new Measurer of Volta-electricity.*

704. I have already said, when engaged in reducing common

* Philosophical Transactions, 1807, pp. 32, 39; also 1826, pp. 387, 389.

and voltaic electricity to one standard of measurement (377.), and again when introducing my theory of electro-chemical decomposition (504. 505. 510.), that the chemical decomposing action of a current *is constant for a constant quantity of electricity*, notwithstanding the greatest variations in its sources, in its intensity, in the size of the *electrodes* used, in the nature of the conductors (or non conductors (307.)) through which it is passed, or in other circumstances. The conclusive proofs of the truth of these statements shall be given almost immediately (783, &c.).

705. I endeavoured upon this law to construct an instrument which should measure out the electricity passing through it, and which, being interposed in the course of the current used in any particular experiment, should serve at pleasure, either as a *comparative standard* of effect, or as a *positive measurer* of this subtle agent.

706. There is no substance better fitted, under ordinary circumstances, to be the indicating body in such an instrument than water; for it is decomposed with facility when rendered a better conductor by the addition of acids or salts; its elements may in numerous cases be obtained and collected without any embarrassment from secondary action, and, being gaseous, they are in the best physical condition for separation and measurement. Water, therefore, acidulated by sulphuric acid, is the substance I shall generally refer to, although it may become expedient in peculiar cases or forms of experiment to use other bodies (843.).

707. The first precaution needful in the construction of the instrument was to avoid the recombination of the evolved gases, an effect which the positive electrode has been found so capable of producing (571.). For this purpose various forms of decomposing apparatus were used. The first consisted of straight tubes, each containing a plate and wire of platina soldered together by gold, and fixed hermetically in the glass at the closed extremity of the tube (Plate V. fig. 60.). The tubes were about eight inches long, 0.7 of an inch in diameter, and graduated. The platina plates were about an inch long, as wide as the tubes would permit, and adjusted as near to the mouths of the tubes as was consistent with the safe collection of the gases evolved. In certain cases, where it was required

to evolve the elements upon as small a surface as possible, the metallic extremity, instead of being a plate, consisted of the wire bent into the form of a ring (fig. 61.). When these tubes were used as measures, they were filled with the dilute sulphuric acid, inverted in a basin of the same liquid (fig. 62.), and placed in an inclined position, with their mouths near to each other, that as little decomposing matter should intervene as possible; and also, in such a direction that the platina plates should be in vertical planes (720.).

708. Another form of apparatus is that delineated (fig. 63.). The tube is bent in the middle; one end is closed; in that end is fixed a wire and plate, *a*, proceeding so far downwards, that, when in the position figured, it shall be as near to the angle as possible, consistently with the collection, at the closed extremity of the tube, of all the gas evolved against it. The plane of this plate is also perpendicular (720.). The other metallic termination, *b*, is introduced at the time decomposition is to be effected, being brought as near the angle as possible, without causing any gas to pass from it towards the closed end of the instrument. The gas evolved against it is allowed to escape.

709. The third form of apparatus contains both electrodes in the same tube; the transmission, therefore, of the electricity, and the consequent decomposition, is far more rapid than in the separate tubes. The resulting gas is the sum of the portions evolved at the two electrodes, and the instrument is better adapted than either of the former as a measurer of the quantity of voltaic electricity transmitted in ordinary cases. It consists of a straight tube (fig. 64.) closed at the upper extremity, and graduated, through the sides of which pass platina wires (being fused into the glass), which are connected with two plates within. The tube is fitted by grinding into one mouth of a double-necked bottle. If the latter be one half or two thirds full of the dilute sulphuric acid (706.), it will, upon inclination of the whole, flow into the tube and fill it. When an electric current is passed through the instrument, the gases evolved against the plates collect in the upper portion of the tube, and are not subject to the recombining power of the platina.

710. Another form of the instrument is given at fig. 65.

711. A fifth form is delineated (fig. 66.). This I have found

exceedingly useful in experiments continued in succession for days together, and where large quantities of indicating gas were to be collected. It is fixed on a weighted foot, and has the form of a small retort containing the two electrodes: the neck is narrow, and sufficiently long to deliver gas issuing from it into a jar placed in a small pneumatic trough. The electrode chamber, sealed hermetically at the part held in the stand, is five inches in length, and 0.6 of an inch in diameter; the neck about nine inches in length, and 0.4 of an inch in diameter internally. The figure will fully indicate the construction.

712. It can hardly be requisite to remark, that in the arrangement of any of these forms of apparatus, they, and the wires connecting them with the substance, which is collaterally subjected to the action of the same electric current, should be so far insulated as to ensure a certainty that all the electricity which passes through the one shall also be transmitted through the other.

713. Next to the precaution of collecting the gases, if mingled, out of contact with the platinum, was the necessity of testing the law of a *definite electrolytic* action, upon water at least, under all varieties of condition; that, with a conviction of its certainty, might also be obtained a knowledge of those interfering circumstances which would require to be practically guarded against.

714. The first point investigated was the influence or indifference of extensive variations in the size of the electrodes, for which purpose instruments like those last described (709. 710. 711.) were used. One of these had plates 0.7 of an inch wide, and nearly four inches long; another had plates only 0.5 of an inch wide, and 0.8 of an inch long; a third had wires 0.02 of an inch in diameter, and three inches long; and a fourth, similar wires only half an inch in length. Yet when these were filled with dilute sulphuric acid, and, being placed in succession, had one common current of electricity passed through them, very nearly the same quantity of gas was evolved in all. The difference was sometimes in favour of one, and sometimes on the side of another; but the general result was that the largest quantity of gases was evolved at the smallest electrodes, namely, those consisting merely of platina wires.

715. Experiments of a similar kind were made with the single-plate, straight tubes (707.), and also with the curved tubes (708.), with similar consequences; and when these, with the former tubes, were arranged together in various ways, the result, as to the equality of action of large and small metallic surfaces when delivering and receiving the same current of electricity, was constantly the same. As an illustration, the following numbers are given. An instrument with two wires evolved 74·3 volumes of mixed gases; another with plates 73·25 volumes; whilst the sum of the oxygen and hydrogen in two separate tubes amounted to 73·65 volumes. In another experiment the volumes were 55·3, 55·3, and 54·4.

716. But it was observed in these experiments, that in single-plate tubes (707.) more hydrogen was evolved at the negative electrode than was proportionate to the oxygen at the positive electrode; and generally, also, more than was proportionate to the oxygen and hydrogen in a double plate-tube. Upon more minutely examining these effects, I was led to refer them, and also the differences between wires and plates (714.), to the solubility of the gases evolved, especially at the positive electrode.

717. When the positive and negative electrodes are equal in surface, the bubbles which rise from them in dilute sulphuric acid are always different in character. Those from the positive plate are exceedingly small, and separate instantly from every part of the surface of the metal, in consequence of its perfect cleanliness (633.); whilst in the liquid they give it a hazy appearance, from their number and minuteness; are easily carried down by currents; and therefore not only present far greater surface of contact with the liquid than larger bubbles would do, but are retained a much longer time in mixture with it. But the bubbles at the negative surface, though they constitute twice the volume of the gas at the positive electrode, are nevertheless very inferior in number. They do not rise so universally from every part of the surface, but seemed to be evolved at different points; and though so much larger, they appear to cling to the metal, separating with difficulty from it, and when separated, instantly rising to the top of the liquid. If, therefore, oxygen and hydrogen had equal solubility in, or powers of combining with, water under similar circumstances, still under the present conditions the oxygen would be far the most liable to solution;

but when to these is added its well-known power of forming a compound with water, it is no longer surprising that such a compound should be produced in small quantities at the positive electrode; and indeed the bleaching power which some philosophers have observed in a solution at this electrode, when chlorine and similar bodies have been carefully excluded, is probably due to the formation there, in this manner, of oxygen-water.

718. That more gas was collected from the wires than from the plates, I attribute to the circumstance, that as equal quantities were evolved in equal times, the bubbles at the wires having been more rapidly produced, in relation to any part of the surface, must have been much larger; have been therefore in contact with the fluid by a much smaller surface, and for a much shorter time than those at the plates; hence less solution and a greater amount collected.

719. There was also another effect produced, especially by the use of large electrodes, which was both a consequence and a proof of the solution of part of the gas evolved there. The collected gas, when examined, was found to contain small portions of nitrogen. This I attribute to the presence of air dissolved in the acid used for decomposition. It is a well-known fact, that when bubbles of a gas but slightly soluble in water or solutions pass through them, the portion of this gas which is dissolved displaces a portion of that previously in union with the liquid: and so, in the decompositions under consideration, as the oxygen dissolves, it displaces a part of the air, or at least of the nitrogen, previously united to the acid; and this effect takes place *most extensively* with large plates, because the gas evolved at them is in the most favourable condition for solution.

720. With the intention of avoiding this solubility of the gases as much as possible, I arranged the decomposing plates in a vertical position (707. 708.), that the bubbles might quickly escape upwards, and that the downward currents in the fluid should not meet ascending currents of gas. This precaution I found to assist greatly in producing constant results, and especially in experiments to be hereafter referred to, in which other liquids than dilute sulphuric acid, as for instance solution of potash, were used.

721. The irregularities in the indications of the measurer proposed, arising from the solubility just referred to, are but small, and may be very nearly corrected by comparing the results of two or three experiments. They may also be almost entirely avoided by selecting that solution which is found to favour them in the least degree (728.); and still further by collecting the hydrogen only, and using that as the indicating gas; for being much less soluble than oxygen, being evolved with twice the rapidity and in larger bubbles (717.), it can be collected more perfectly and in greater purity.

722. From the foregoing and many other experiments, it results that *variation in the size of the electrodes causes no variation in the chemical action of a given quantity of electricity upon water.*

723. The next point in regard to which the principle of constant electro-chemical action was tested, was *variation of intensity*. In the first place, the preceding experiments were repeated, using batteries of an *equal* number of plates, *strongly* and *weakly* charged; but the results were alike. They were then repeated, using batteries sometimes containing forty, and at other times only five pairs of plates; but the results were still the same. *Variations therefore in the intensity*, caused by difference in the strength of charge, or in the number of alternations used, *produced no difference as to the equal action of large and small electrodes.*

724. Still these results did not prove that variation in the intensity of the current was not accompanied by a corresponding variation in the electro-chemical effects, since the actions at *all* the surfaces might have increased or diminished together. The deficiency in the evidence is, however, completely supplied by the former experiments on different-sized electrodes; for with variation in the size of these, a variation in the intensity must have occurred. The intensity of an electric current traversing conductors alike in their nature, quality, and length, is probably as the quantity of electricity passing through a given sectional area perpendicular to the current, divided by the time (360. *note*); and therefore when large plates were contrasted with wires separated by an equal length of the same decomposing conductor (714.), whilst one current of electricity passed through

both arrangements, that electricity must have been in a very different state, as to *tension*, between the plates and between the wires; yet the chemical results were the same.

725. The difference in intensity, under the circumstances described, may be easily shown practically, by arranging two decomposing apparatus as in fig. 67, where the same fluid is subjected to the decomposing power of the same current of electricity, passing in the vessel A. between large platina plates, and in the vessel B. between small wires. If a third decomposing apparatus, such as that delineated fig. 66. (711.), be connected with the wires at *a, b*, fig. 67, it will serve sufficiently well, by the degree of decomposition occurring in it, to indicate the relative state of the two plates as to intensity; and if it then be applied in the same way, as a test of the state of the wires at *a' b'*, it will, by the increase of decomposition within, show how much greater the intensity is there than at the former points. The connexions of P and N with the voltaic battery are of course to be continued during the whole time.

726. A third form of experiment in which difference of intensity was obtained, for the purpose of testing the principle of equal chemical action, was to arrange three volta-electrometers, so that after the electric current had passed through one, it should divide into two parts, each of which should traverse one of the remaining instruments, and should then reunite. The sum of the decomposition in the two latter vessels was always equal to the decomposition in the former vessel. But the *intensity* of the divided current could not be the same as that it had in its original state; and therefore *variation of intensity has no influence on the results if the quantity of electricity remain the same*. The experiment, in fact, resolves itself simply into an increase in the size of the electrodes (725.).

727. The *third point*, in respect to which the principle of equal electro-chemical action on water was tested, was *variation of the strength of the solution used*. In order to render the water a conductor, sulphuric acid had been added to it (707.); and it did not seem unlikely that this substance, with many others, might render the water more subject to decomposition, the electricity remaining the same in quantity. But such did not

prove to be the case. Diluted sulphuric acid, of different strengths, was introduced into different decomposing apparatus, and submitted simultaneously to the action of the same electric current (714.). Slight differences occurred, as before, sometimes in one direction, sometimes in another; but the final result was, that *exactly the same quantity of water was decomposed in all the solutions by the same quantity of electricity*, though the sulphuric acid in some was seventy-fold what it was in others. The strengths used were of specific gravity 1.495, and downwards.

728. When an acid having a specific gravity of about 1.336 was employed, the results were most uniform, and the oxygen and hydrogen (716.) most constantly in the right proportion to each other. Such an acid gave more gas than one much weaker acted upon by the same current, apparently because it had less solvent power. If the acid were very strong, then a remarkable disappearance of oxygen took place; thus, one made by mixing two measures of strong oil of vitriol with one of water, gave forty-two volumes of hydrogen, but only twelve of oxygen. The hydrogen was very nearly the same with that evolved from acid of the specific gravity 1.232. I have not yet had time to examine minutely the circumstances attending the disappearance of the oxygen in this case, but imagine it is due to the formation of oxywater, which Thénard has shown is favoured by the presence of acid.

729. Although not necessary for the practical use of the instrument I am describing, yet as connected with the important point of constant electro-chemical action upon water, I now investigated the effects produced by an electric current passing through aqueous solutions of acids, salts, and compounds, exceedingly different from each other in their nature, and found them to yield astonishingly uniform results. But many of them which are connected with a secondary action will be more fully described hereafter (778.).

730. When solutions of caustic potassa or soda, or sulphate of magnesia, or sulphate of soda, were acted upon by the electric current, just as much oxygen and hydrogen was evolved from them as from the diluted sulphuric acid, with which they were compared. When a solution of ammonia, rendered a better

conductor by sulphate of ammonia (554.), or a solution of sub-carbonate of potassa was experimented with, the *hydrogen* evolved was in the same quantity as that set free from the diluted sulphuric acid with which they were compared. Hence *changes in the nature of the solution do not alter the constancy of electrolytic action upon water.*

731. I have already said, respecting large and small electrodes, that change of order caused no change in the general effect (715.). The same was the case with different solutions, or with different intensities; and however the circumstances of an experiment might be varied, the results came forth exceedingly consistent, and proved that the electro-chemical action was still the same.

732. I consider the foregoing investigation as sufficient to prove the very extraordinary and important principle with respect to WATER, *that when subjected to the influence of the electric current, a quantity of it is decomposed exactly proportionate to the quantity of electricity which has passed, notwithstanding the thousand variations in the conditions and circumstances under which it may at the time be placed; and further, that when the interference of certain secondary effects (742. &c.), together with the solution or recombination of the gas and the evolution of air, are guarded against, the products of the decomposition may be collected with such accuracy, as to afford a very excellent and valuable measurer of the electricity concerned in their evolution.*

733. The forms of instrument which I have given, figg. 64, 65, 66 (709. 710. 711.), are probably those which will be found most useful, as they indicate the quantity of electricity by the largest volume of gases, and cause the least obstruction to the passage of the current. The fluid which my present experience leads me to prefer, is a solution of sulphuric acid of specific gravity about 1.336, or from that to 1.25; but it is very essential that there should be no organic substance, nor any vegetable acid, nor other body, which, by being liable to the action of the oxygen or hydrogen evolved at the electrodes (773. &c.), shall diminish their quantity, or add other gases to them.

734. In many cases when the instrument is used as a *com-*

parative standard, or even as a *measurer*, it may be desirable to collect the hydrogen only, as being less liable to absorption or disappearance in other ways than the oxygen; whilst at the same time its volume is so large, as to render it a good and sensible indicator. In such cases the first and second form of apparatus have been used, figg. 62, 63 (707. 708.). The indications obtained were very constant, the variations being much smaller than in those forms of apparatus collecting both gases; and they can also be procured when solutions are used in comparative experiments, which, yielding no oxygen or only secondary results of its action, can give no indications if the educts at both electrodes be collected. Such is the case when solutions of ammonia, muriatic acid, chlorides, iodides, acetates or other vegetable salts, &c., are employed.

735. In a few cases, as where solutions of metallic salts liable to reduction at the negative electrode are acted upon, the oxygen may be advantageously used as the measuring substance. This is the case, for instance, with sulphate of copper.

736. There are therefore two general forms of the instrument which I submit as a measurer of electricity; one, in which both the gases of the water decomposed are collected (709. 710. 711.); and the other, in which a single gas, as the hydrogen only, is used (707. 708.). When referred to as a *comparative instrument*, (a use I shall now make of it very extensively,) it will not often require particular precaution in the observation; but when used as an *absolute measurer*, it will be needful that the barometric pressure and the temperature be taken into account, and that the graduation of the instruments should be to one scale: the hundredths and smaller divisions of a cubical inch are quite fit for this purpose, and the hundredth may be very conveniently taken as indicating a DEGREE of electricity.

737. It can scarcely be needful to point out further than has been done how this instrument is to be used. It is to be introduced into the course of the electric current, the action of which is to be exerted anywhere else, and if 60° or 70° of electricity are to be measured out, either in one or several portions, the current, whether strong or weak, is to be continued until the gas in the tube occupies that number of divisions or

hundredths of a cubical inch. Or if a quantity competent to produce a certain effect is to be measured, the effect is to be obtained, and then the indication read off. In exact experiments it is necessary to correct the volume of gas for changes in temperature and pressure, and especially for moisture*. For the latter object the volta-electrometer (fig. 66.) is most accurate, as its gas can be measured over water, whilst the others retain it over acid or saline solutions.

738. I have not hesitated to apply the term *degree* (736), in analogy with the use made of it with respect to another most important imponderable agent, namely, heat; and as the definite expansion of air, water, mercury, &c., is there made use of to measure heat, so the equally definite evolution of gases is here turned to a similar use for electricity.

739. The instrument offers the only *actual measurer* of voltaic electricity which we at present possess. For without being at all affected by variations in time or intensity, or alterations in the current itself, of any kind, or from any cause, or even of intermissions of action, it takes note with accuracy of the quantity of electricity which has passed through it, and reveals that quantity by inspection; I have therefore named it a VOLTA-ELECTROMETER.

740. Another mode of measuring volta-electricity may be adopted with advantage in many cases, dependent on the quantities of metals or other substances evolved either as primary or as secondary results; but I refrain from enlarging on this use of the products, until the principles on which their constancy depends have been fully established (791. 843.).

741. By the aid of this instrument I have been able to establish the definite character of electro-chemical action in its most general sense; and I am persuaded it will become of the utmost use in the extensions of the science which these views afford. I do not pretend to have made its detail perfect, but to have demonstrated the truth of the principle, and the utility of the application†.

* For a simple table of correction for moisture, I may take the liberty of referring to my *Chemical Manipulation*, edition of 1830, p. 376.

† As early as the year 1811, Messrs. Gay Lussac, and Thénard, employed chemical decomposition as a measure of the electricity of the voltaic pile. See *Recherches Physico-chymiques*, p. 12. The principles and precautions by which it becomes an exact measure were of course not then known.—*Dec.* 1838.

¶ vi. *On the primary or secondary character of the bodies evolved at the Electrodes.*

742. Before the *volta-electrometer* could be employed in determining, as a *general law*, the constancy of electro-decomposition, it became necessary to examine a distinction, already recognised among scientific men, relative to the products of that action, namely, their primary or secondary character; and, if possible, by some general rule or principle, to decide when they were of the one or the other kind. It will appear hereafter that great mistakes respecting electro-chemical action and its consequences have arisen from confounding these two classes of results together.

743. When a substance under decomposition yields at the electrodes those bodies uncombined and unaltered which the electric current has separated, then they may be considered as primary results, even though themselves compounds. Thus the oxygen and hydrogen from water are primary results; and so also are the acid and alkali (themselves compound bodies) evolved from sulphate of soda. But when the substances separated by the current are changed at the electrodes before their appearance, then they give rise to secondary results, although in many cases the bodies evolved are elementary.

744. These secondary results occur in two ways, being sometimes due to the mutual action of the evolved substance and the matter of the electrode, and sometimes to its action upon the substances contained in the body itself under decomposition. Thus, when carbon is made the positive electrode in dilute sulphuric acid, carbonic oxide and carbonic acid occasionally appear there instead of oxygen; for the latter, acting upon the matter of the electrode, produces these secondary results. Or if the positive electrode, in a solution of nitrate or acetate of lead, be platina, then peroxide of lead appears there, equally a secondary result with the former, but now depending upon an action of the oxygen on a substance in the solution. Again, when ammonia is decomposed by platina electrodes, nitrogen appears at the *anode**; but though an *elementary* body, it is a *secondary* result in this case, being derived from the chemical action of the oxygen electrically evolved there, upon the am-

* Annales de Chimie, 1804, tom. li. p. 167.

monia in the surrounding solution (554.). In the same manner when aqueous solutions of metallie salts are decomposed by the current, the metals evolved at the *cathode*, though elements, are *always* secondary results, and not immediate consequences of the decomposing power of the electric current.

745. Many of these secondary results are extremely valuable; for instance, all the interesting compounds which M. Bequerel has obtained by feeble electric currents are of this nature; but they are essentially chemical, and must, in the theory of electrolytic action, be carefully distinguished from those which are directly due to the action of the electric current.

746. The nature of the substances evolved will often lead to a correct judgment of their primary or secondary character, but is not sufficient alone to establish that point. Thus, nitrogen is said to be attracted sometimes by the positive and sometimes by the negative electrode, according to the bodies with which it may be combined (554. 555.), and it is on such occasions evidently viewed as a primary result*; but I think I shall show, that, when it appears at the positive electrode, or rather at the *anode*, it is a secondary result (748.). Thus, also, Sir Humphry Davy†, and with him the great body of chemical philosophers, (including myself,) have given the appearance of copper, lead, tin, silver, gold, &c., at the negative electrode, when their aqueous solutions were acted upon by the voltaic current, as proofs that the metals, as a class, were attracted to that surface; thus assuming the metal, in each case, to be a primary result. These, however, I expect to prove, are all secondary results; the mere consequence of chemical action, and no proofs either of the attraction of the law announced respecting their places‡.

747. But when we take to our assistance the law of *constant electro-chemical action* already proved with regard to water (732.), and which I hope to extend satisfactorily to all bodies

* Annales de Chimie, 1804, tom. li. p. 172.

† Elements of Chemical Philosophy, pp. 144, 161.

‡ It is remarkable that up to 1804 it was the received opinion that the metals were reduced by the nascent hydrogen. At that date the general opinion was reversed by Hisinger and Berzelius (Annales de Chimie, 1804, tom. li. p. 174.), who stated that the metals were evolved directly by the electricity: in which opinion it appears, from that time, Davy coincided (Philosophical Transactions, 1826, p. 388.).

(821.), and consider the *quantities* as well as the *nature* of the substances set free, a generally accurate judgment of the primary or secondary character of the results may be formed: and this important point, so essential to the theory of electrolyzation, since it decides what are the particles directly under the influence of the current, (distinguishing them from such as are not affected), and what are the results to be expected, may be established with such degree of certainty as to remove innumerable ambiguities and doubtful considerations from this branch of the science.

748. Let us apply these principles to the case of ammonia, and the supposed determination of nitrogen to one or the other *electrode* (554. 555.). A pure strong solution of ammonia is as bad a conductor, and therefore as little liable to electrolyzation, as pure water; but when sulphate of ammonia is dissolved in it, the whole becomes a conductor; nitrogen *almost* and occasionally *quite* pure is evolved at the *anode*, and hydrogen at the *cathode*; the ratio of the volume of the former to that of the latter varying, but being as 1 to about 3 or 4. This result would seem at first to imply that the electric current had decomposed ammonia, and that the nitrogen had been determined towards the positive electrode. But when the electricity used was measured out by the volta-electrometer (707. 736.), it was found that the hydrogen obtained was exactly in the proportion which would have been supplied by decomposed water, whilst the nitrogen had no certain or constant relation whatever. When, upon multiplying experiments, it was found that, by using a stronger or weaker solution, or a more or less powerful battery, the gas evolved at the *anode* was a mixture of oxygen and nitrogen, varying both in proportion and absolute quantity, whilst the hydrogen at the *cathode* remained constant, no doubt could be entertained that the nitrogen at the *anode* was a secondary result, depending upon the chemical action of the nascent oxygen, determined to that surface by the electric current, upon the ammonia in solution. It was the water, therefore, which was electrolyzed, not the ammonia. Further, the experiment gives no real indication of the tendency of the element nitrogen to either one electrode or the other; nor do I know of any experiment with nitric acid, or other compounds of nitrogen, which shows the tendency of this element, under the influence

of the electric current, to pass in either direction along its course.

749. As another illustration of secondary results, the effects on a solution of acetate of potassa may be quoted. When a very strong solution was used, more gas was evolved at the *anode* than at the *cathode*, in the proportion of 4 to 3 nearly: that from the *anode* was a mixture of carbonic oxide and carbonic acid; that from the *cathode* pure hydrogen. When a much weaker solution was used, less gas was evolved at the *anode* than at the *cathode*; and it now contained carburetted hydrogen, as well as carbonic oxide and carbonic acid. This result of carburetted hydrogen at the positive electrode has a very anomalous appearance, if considered as an immediate consequence of the decomposing power of the current. It, however, as well as the carbonic oxide and acid, is only a *secondary result*; for it is the water alone which suffers electro-decomposition, and it is the oxygen eliminated at the *anode* which, reacting on the acetic acid, in the midst of which it is evolved, produces those substances that finally appear there. This is fully proved by experiments with the volta-electrometer (707.); for then the hydrogen evolved from the acetate at the *cathode* is always found to be definite, being exactly proportionate to the electricity which has passed through the solution, and, in quantity, the same as the hydrogen evolved in the volta-electrometer itself. The appearance of the carbon in combination with the hydrogen at the positive electrode, and its non-appearance at the negative electrode, are in curious contrast with the results which might have been expected from the law usually accepted respecting the final places of the elements.

750. If the salt in solution be an acetate of lead, then the results at both electrodes are secondary, and cannot be used to estimate or express the amount of electro-chemical action, except by a circuitous process (843.). In place of oxygen or even the gases already described (749.), peroxide of lead now appears at the positive, and lead itself at the negative electrode. When other metallic solutions are used, containing, for instance, peroxides, as that of copper, combined with this or any other decomposable acid, still more complicated results will be obtained; which, viewed as direct results of the electro-chemical

action, will, in their proportions, present nothing but confusion, but will appear perfectly harmonious and simple if they be considered as secondary results, and will accord in their proportions with the oxygen and hydrogen evolved from water by the action of a definite quantity of electricity.

751. I have experimented upon many bodies, with a view to determine whether the results were primary or secondary. I have been surprised to find how many of them, in ordinary cases, are of the latter class, and how frequently water is the only body electrolyzed in instances where other substances have been supposed to give way. Some of these results I will give in as few words as possible.

752. *Nitric acid*.—When very strong, it conducted well, and yielded oxygen at the positive electrode. No gas appeared at the negative electrode; but nitrous acid, and apparently nitric oxide, were formed there, which, dissolving, rendered the acid yellow or red, and at last even effervescent, from the spontaneous separation of nitric oxide. Upon diluting the acid with its bulk or more of water, gas appeared at the negative electrode. Its quantity could be varied by variations, either in the strength of the acid or of the voltaic current: for that acid from which no gas separated at the *cathode*, with a weak voltaic battery, did evolve gas there with a stronger; and that battery which evolved no gas there with a strong acid, did cause its evolution with an acid more dilute. The gas at the *anode* was always oxygen; that at the *cathode* hydrogen. When the quantity of products was examined by the volta-electrometer (707.), the oxygen, whether from strong or weak acid, proved to be in the same proportion as from water. When the acid was diluted to specific gravity 1.24, or less, the hydrogen also proved to be the same in quantity as from water. Hence I conclude that the nitric acid does not undergo electrolyzation, but the water only; that the oxygen at the *anode* is always a primary result, but that the products at the *cathode* are often secondary, and due to the reaction of the hydrogen upon the nitric acid.

753. *Nitre*.—A solution of this salt yields very variable results, according as one or other form of tube is used, or as the electrodes are large or small. Sometimes the whole of the hydrogen of the water decomposed may be obtained at the nega-

tive electrode; at other times, only a part of it, because of the ready formation of secondary results. The solution is a very excellent conductor of electricity.

754. *Nitrate of ammonia*, in aqueous solution, gives rise to secondary results very varied and uncertain in their proportions.

755. *Sulphurous acid*.—Pure liquid sulphurous acid does not conduct nor suffer decomposition by the voltaic current*, but, when dissolved in water, the solution acquires conducting power, and is decomposed, yielding oxygen at the *anode*, and hydrogen and sulphur at the *cathode*.

756. A solution containing sulphuric acid in addition to the sulphurous acid, was a better conductor. It gave very little gas at either electrode: that at the *anode* was oxygen, that at the *cathode* pure hydrogen. From the *cathode* also rose a white turbid stream, consisting of diffused sulphur, which soon rendered the whole solution milky. The volumes of gases were in no regular proportion to the quantities evolved from water in the voltameter. I conclude that the sulphurous acid was not at all affected by the electric current in any of these cases, and that the water present was the only body electro-chemically decomposed; that, at the *anode*, the oxygen from the water converted the sulphurous acid into sulphuric acid, and, at the *cathode*, the hydrogen electrically evolved decomposed the sulphurous acid, combining with its oxygen, and setting its sulphur free. I conclude that the sulphur at the negative electrode was only a secondary result; and, in fact, no part of it was found combined with the small portion of hydrogen which escaped when weak solutions of sulphurous acid were used.

757. *Sulphuric acid*.—I have already given my reasons for concluding that sulphuric acid is not electrolyzable, *i. e.* not decomposable directly by the electric current, but occasionally suffering by a secondary action at the *cathode* from the hydrogen evolved there (681.). In the year 1800, Davy considered the sulphur from sulphuric acid as the result of the action of the nascent hydrogen†. In 1804, Hisinger and Berzelius stated

* See also De la Rive, *Bibliothèque Universelle*, tom. xl. p. 205; or *Quarterly Journal of Science*, vol. xxvii. p. 407.

† Nicholson's *Quarterly Journal*, vol. iv. pp. 280, 281.

that it was the direct result of the action of the voltaic pile*, an opinion which from that time Davy seems to have adopted, and which has since been commonly received by all. The change of my own opinion requires that I should correct what I have already said of the decomposition of sulphuric acid in a former series of these Researches (552.): I do not now think that the appearance of the sulphur at the negative electrode is an immediate consequence of electrolytic action.

758. *Muriatic acid.*—A strong solution gave hydrogen at the negative electrode, and chlorine only at the positive electrode; of the latter, a part acted on the platina and a part was dissolved. A minute bubble of gas remained; it was not oxygen, but probably air previously held in solution.

759. It was an important matter to determine whether the chlorine was a primary result, or only a secondary product, due to the action of the oxygen evolved from water at the *anode* upon the muriatic acid; *i. e.* whether the muriatic acid was electrolyzable, and if so, whether the decomposition was *definite*.

760. The muriatic acid was gradually diluted. One part with six of water gave only chlorine at the *anode*. One part with eight of water gave only chlorine; with nine of water, a little oxygen appeared with the chlorine: but the occurrence or non-occurrence of oxygen at these strengths depended, in part, on the strength of the voltaic battery used. With fifteen parts of water, a little oxygen, with much chlorine, was evolved at the *anode*. As the solution was now becoming a bad conductor of electricity, sulphuric acid was added to it: this caused more ready decomposition, but did not sensibly alter the proportion of chlorine and oxygen.

761. The muriatic acid was now diluted with 100 times its volume of dilute sulphuric acid. It still gave a large proportion of chlorine at the *anode*, mingled with oxygen; and the result was the same, whether a voltaic battery of 40 pairs of plates or one containing only 5 pairs were used. With acid of this strength, the oxygen evolved at the *anode* was to the hydrogen at the *cathode*, in volume, as 17 is to 64; and therefore the chlorine would have been 30 volumes, had it not been dissolved by the fluid.

* *Annales de Chimie*, 1804, tom. li. p. 173.

762. Next with respect to the quantity of elements evolved. On using the volta-electrometer, it was found that, whether the strongest or the weakest muriatic acid were used, whether chlorine alone or chlorine mingled with oxygen appeared at the *anode*, still the hydrogen evolved at the *cathode* was a constant quantity, *i. e.* exactly the same as the hydrogen which the *same quantity of electricity* could evolve from water.

763. This constancy does not decide whether the muriatic acid is electrolyzed or not, although it proves that if so, it must be in definite proportions to the quantity of electricity used. Other considerations may, however, be allowed to decide the point. The analogy between chlorine and oxygen, in their relations to hydrogen, is so strong, as to lead almost to the certainty, that, when combined with that element, they would perform similar parts in the process of electro-decomposition. They both unite with it in single proportional or equivalent quantities; and the number of proportionals appearing to have an intimate and important relation to the decomposability of a body (697.), those in muriatic acid, as well as in water are the most favourable, or those perhaps even necessary, to decomposition. In other binary compounds of chlorine also, where nothing equivocal depending on the simultaneous presence of it and oxygen is involved, the chlorine is directly eliminated at the *anode* by the electric current. Such is the case with the chloride of lead (395.), which may be justly compared with protoxide of lead (402.), and stands in the same relation to it as muriatic acid to water. The chlorides of potassium, sodium, barium, &c., are in the same relation to the protoxides of the same metals and present the same results under the influence of the electric current (402.).

764. From all the experiments, combined with these considerations, I conclude that muriatic acid is decomposed by the direct influence of the electric current, and that the quantities evolved are, and therefore the chemical action is, *definite for a definite quantity of electricity*. For though I have not collected and measured the chlorine, in its separate state, at the *anode*, there can exist no doubt as to its being proportional to the hydrogen at the *cathode*: and the results are therefore sufficient to establish the general law of *constant electro-chemical action* in the case of muriatic acid.

765. In the dilute acid (761.), I conclude that a part of the water is electro-chemically decomposed, giving origin to the oxygen, which appears mingled with the chlorine at the *anode*. The oxygen *may* be viewed as a secondary result; but I incline to believe that it is not so: for, if it were, it might be expected in largest proportion from the stronger acid, whereas the reverse is the fact. This consideration, with others, also leads me to conclude that muriatic acid is more easily decomposed by the electric current than water; since, even when diluted with eight or nine times its quantity of the latter fluid, it alone gives way, the water remaining unaffected.

766. *Chlorides*.—On using solutions of chlorides in water,—for instance, the chlorides of sodium or calcium,—there was evolution of chlorine only at the positive electrode, and of hydrogen, with the oxide of the base, as soda or lime, at the negative electrode. The process of decomposition may be viewed as proceeding in two or three ways, all terminating in the same results. Perhaps the simplest is to consider the chloride as the substance electrolyzed, its chlorine being determined to and evolved at the *anode*, and its metal passing to the *cathode*, where, finding no more chlorine, it acts upon the water, producing hydrogen and an oxide as secondary results. As the discussion would detain me from more important matter, and is not of immediate consequence, I shall defer it for the present. It is, however, of *great consequence* to state, that, on using the volta-electrometer, the hydrogen in both cases was definite; and if the results do not prove the definite decomposition of chlorides, (which shall be proved elsewhere,—789. 794. 814.) they are not in the slightest degree opposed to such a conclusion, and do support the *general law*.

767. *Hydriodic acid*.—A solution of hydriodic acid was affected exactly in the same manner as muriatic acid. When strong, hydrogen was evolved at the negative electrode, in definite proportion to the quantity of electricity which had passed, *i. e.* in the same proportion as was evolved by the same current from water; and iodine without any oxygen was evolved at the positive electrode. But when diluted, small quantities of oxygen appeared with the iodine at the *anode*, the proportion of hydrogen at the *cathode* remaining undisturbed.

768. I believe the decomposition of the hydriodic acid in this

ease to be direct, for the reasons already given respecting muriatic acid (763. 764.).

769. *Iodides.*—A solution of iodide of potassium being subjected to the voltaic current, iodine appeared at the positive electrode (without any oxygen), and hydrogen with free alkali at the negative electrode. The same observations as to the mode of decomposition are applicable here as were made in relation to the chlorides when in solution (766.).

770. *Hydro-fluoric acid and fluorides.*—Solution of hydro-fluoric acid did not appear to be decomposed under the influence of the electric current : it was the water which gave way apparently. The fused fluorides were electrolyzed (417.); but having during these actions obtained *fluorine* in the separate state, I think it better to refer to a future series of these Researches, in which I purpose giving a fuller account of the results than would be consistent with propriety here*.

771. *Hydro-cyanic acid* in solution conducts very badly. The definite proportion of hydrogen (equal to that from water) was set free at the *cathode*, whilst at the *anode* a small quantity of oxygen was evolved and apparently a solution of cyanogen formed. The action altogether corresponded with that on a dilute muriatic or hydriodic acid. When the hydro-cyanic acid was made a better conductor by sulphuric acid, the same results occurred.

Cyanides.—With a solution of the cyanide of potassium, the result was precisely the same as with a chloride or iodide. No oxygen was evolved at the positive electrode, but a brown solution formed there. For the reasons given when speaking of the chlorides (766.), and because a fused cyanide of potassium evolves cyanogen at the positive electrode †, I incline to believe that the cyanide in solution is *directly* decomposed.

772. *Ferro-cyanic acid* and the *ferro-cyanides*, as also *sulpho-cyanic acid* and the *sulpho-cyanides*, presented results corresponding with those just described (771.).

* I have not obtained fluorine : my expectations, amounting to conviction, passed away one by one when subjected to rigorous examination ; some very singular results were obtained ; and to one of these I refer at 1340.—(Dec. 1838).

† It is a very remarkable thing to see carbon and nitrogen in this ease determined powerfully towards the positive surface of the voltaic battery ; but it is perfectly in harmony with the theory of electro-chemical decomposition which I have advanced.

773. *Acetic acid*.—Glacial acetic acid, when fused (405.), is not decomposed by, nor does it conduct, electricity. On adding a little water to it, still there were no signs of action; on adding more water, it acted slowly and about as pure water would do. Dilute sulphuric acid was added to it in order to make it a better conductor; then the definite proportion of hydrogen was evolved at the *cathode*, and a mixture of oxygen in very deficient quantity, with carbonic acid, and a little carbonic oxide, at the *anode*. Hence it appears that acetic acid is not electrolyzable, but that a portion of it is decomposed by the oxygen evolved at the *anode*, producing secondary results, varying with the strength of the acid, the intensity of the current, and other circumstances.

774. *Acetates*.—One of these has been referred to already, as affording only secondary results relative to the acetic acid (749.). With many of the metallic acetates the results at both electrodes are secondary (746. 750.).

Acetate of soda fused and anhydrous is directly decomposed, being, as I believe, a true electrolyte, and evolving soda and acetic acid at the *cathode* and *anode*. These however have no sensible duration, but are immediately resolved into other substances; charcoal, sodiuretted hydrogen, &c. being set free at the former, and, as far as I could judge under the circumstances, acetic acid mingled with carbonic oxide, carbonic acid, &c. at the latter.

775. *Tartaric acid*.—Pure solution of tartaric acid is almost as bad a conductor as pure water. On adding sulphuric acid, it conducted well, the results at the positive electrode being primary or secondary in different proportions, according to variations in the strength of the acid and the power of the electric current (752.). Alkaline tartrates gave a large proportion of secondary results at the positive electrode. The hydrogen at the negative electrode remained constant unless certain triple metallic salts were used.

776. Solutions, of salts containing other vegetable acids, as the benzoates; of sugar, gum, &c., dissolved in dilute sulphuric acid; of resin, albumen, &c., dissolved in alkalies, were in turn submitted to the electrolytic power of the voltaic current. In all these cases, secondary results to a greater or smaller extent were produced at the positive electrode.

777. In concluding this division of these Researches, it can-

not but occur to the mind that the final result of the action of the electric current upon substances placed between the electrodes, instead of being simple may be very complicated. There are two modes by which these substances may be decomposed, either by the direct force of the electric current, or by the action of bodies which that current may evolve. There are also two modes by which new compounds may be formed, *i. e.* by combination of the evolving substances whilst in their nascent state (658.), directly with the matter of the electrode; or else their combination with those bodies, which being contained in, or associated with, the body suffering decomposition, are necessarily present at the *anode* and *cathode*. The complexity is rendered still greater by the circumstance that two or more of these actions may occur simultaneously, and also in variable proportions to each other. But it may in a great measure be resolved by attention to the principles already laid down (747.).

778. When *aqueous* solutions of bodies are used, secondary results are exceedingly frequent. Even when the water is not present in large quantity, but is merely that of combination, still secondary results often ensue: for instance, it is very possible that in Sir Humphry Davy's decomposition of the hydrates of potassa and soda, a part of the potassium produced was the result of a secondary action. Hence, also, a frequent cause for the disappearance of the oxygen and hydrogen which would otherwise be evolved: and when hydrogen does *not* appear at the *cathode* in an *aqueous solution*, it perhaps always indicates that a secondary action has taken place there. No exception to this rule has as yet occurred to my observation.

779. Secondary actions are *not confined to aqueous solutions*, or cases where water is present. For instance, various chlorides acted upon, when fused (402.), by platina electrodes, have the chlorine determined electrically to the *anode*. In many cases, as with the chlorides of lead, potassium, barium, &c., the chlorine acts on the platina and forms a compound with it, which dissolves; but when protochloride of tin is used, the chlorine at the *anode* does not act upon the platina, but upon the chloride already there, forming a perchloride which rises in vapour (790. 804.). These are, therefore, instances of

secondary actions of both kinds, produced in bodies containing no water.

780. The production of boron from fused borax (402, 417.) is also a case of secondary action; for boric acid is not decomposable by electricity (408.), and it was the sodium evolved at the *cathode* which, re-acting on the boric acid around it, took oxygen from it, and set boron free in the experiments formerly described.

781. Secondary actions have already in the hands of M. Becquerel, produced many interesting results in the formation of compounds; some of them new, others imitations of those occurring naturally*. It is probable they may prove equally interesting in an opposite direction, *i. e.* as affording cases of analytic decomposition. Much information regarding the composition, and perhaps even the arrangement, of the particles of such bodies as the vegetable acids and alkalies, and organic compounds generally, will probably be obtained by submitting them to the action of nascent oxygen, hydrogen, chlorine, &c. at the electrodes; and the action seems the more promising, because of the thorough command which we possess over attendant circumstances, such as the strength of the current, the size of the electrodes, the nature of the decomposing conductor, its strength, &c., all of which may be expected to have their corresponding influence upon the final result.

782. It is to me a great satisfaction that the extreme variety of secondary results has presented nothing opposed to the doctrine of a constant and definite electro-chemical action, to the particular consideration of which I shall now proceed.

¶ vii. *On the definite nature and extent of Electro-Chemical Decomposition.*

783. In the third series of these Researches, after proving the identity of electricities derived from different sources, and showing, by actual measurement, the extraordinary quantity of electricity evolved by a very feeble voltaic arrangement (371. 376.), I announced a law, derived from experiment, which seemed to me of the utmost importance to the science of elec-

* Annales de Chimie, tom. xxxv. p. 113.

tricity in general, and that branch of it denominated electro-chemistry in particular. The law was expressed thus: *The chemical power of a current of electricity is in direct proportion to the absolute quantity of electricity which passes* (377.).

784. In the further progress of the successive investigations, I have had frequent occasion to refer to the same law, sometimes in circumstances offering powerful corroboration of its truth (456. 504. 505.); and the present series already supplies numerous new cases in which it holds good (704. 722. 726. 732.). It is now my object to consider this great principle more closely, and to develop some of the consequences to which it leads. That the evidence for it may be the more distinct and applicable, I shall quote cases of decomposition subject to as few interferences from secondary results as possible, effected upon bodies very simple, yet very definite in their nature.

785. In the first place, I consider the law as so fully established with respect to the decomposition of *water*, and under so many circumstances which might be supposed, if anything could, to exert an influence over it, that I may be excused entering into further detail respecting that substance, or even summing up the results here (732.). I refer, therefore, to the whole of the subdivision of this series of Researches which contains the account of the *volta-electrometer* (704. &c.).

786. In the next place, I also consider the law as established with respect to *muriatic acid* by the experiments and reasoning already advanced, when speaking of that substance, in the subdivision respecting primary and secondary results (758. &c.).

787. I consider the law as established also with regard to *hydriodic acid* by the experiments and considerations already advanced in the preceding division of this series of Researches (767. 768.).

788. Without speaking with the same confidence, yet from the experiments described, and many others not described, relating to hydro-fluoric, hydro-cyanic, ferro-cyanic, and sulpho-cyanic acids (770. 771. 772.), and from the close analogy which holds between these bodies and the hydracids of chlorine, iodine, bromine, &c., I consider these also as coming under subjection to the law, and assisting to prove its truth.

789. In the preceding cases, except the first, the water is believed to be inactive; but to avoid any ambiguity arising

from its presence, I sought for substances from which it should be absent altogether; and, taking advantage of the law of conduction already developed (380. &c.), I soon found abundance, amongst which *protochloride of tin* was first subjected to decomposition in the following manner. A piece of platina wire had one extremity coiled up into a small knob, and, having been carefully weighed, was sealed hermetically into a piece of bottle-glass tube, so that the knob should be at the bottom of the tube within (fig. 68.). The tube was suspended by a piece of platina wire, so that the heat of a spirit-lamp could be applied to it. Recently fused protochloride of tin was introduced in sufficient quantity to occupy, when melted, about one half of the tube; the wire of the tube was connected with a volta-electrometer (711.), which was itself connected with the negative end of a voltaic battery; and a platina wire connected with the positive end of the same battery was dipped into the fused chloride in the tube; being however so bent, that it could not by any shake of the hand or apparatus touch the negative electrode at the bottom of the vessel. The whole arrangement is delineated in fig. 69.

790. Under these circumstances the chloride of tin was decomposed: the chlorine evolved at the positive electrode formed bichloride of tin (779.), which passed away in fumes, and the tin evolved at the negative electrode combined with the platina, forming an alloy, fusible at the temperature to which the tube was subjected, and therefore never occasioning metallic communication through the decomposing chloride. When the experiment had been continued so long as to yield a reasonable quantity of gas in the volta-electrometer, the battery connexion was broken, the positive electrode removed, and the tube and remaining chloride allowed to cool. When cold, the tube was broken open, the rest of the chloride and the glass being easily separable from the platina wire and its button of alloy. The latter when washed was then reweighed, and the increase gave the weight of the tin reduced.

791. I will give the particular results of one experiment, in illustration of the mode adopted in this and others, the results of which I shall have occasion to quote. The negative electrode weighed at first 20 grains; after the experiment, it, with its button of alloy, weighed 23.2 grains. The tin evolved by

the electric current at the *cathode* weighed therefore 3·2 grains. The quantity of oxygen and hydrogen collected in the volta-electrometer = 3·85 cubic inches. As 100 cubic inches of oxygen and hydrogen, in the proportions to form water, may be considered as weighing 12·92 grains, the 3·85 cubic inches would weigh 0·49742 of a grain; that being, therefore, the weight of water decomposed by the same electric current as was able to decompose such weight of protochloride of tin as could yield 3·2 grains of metal. Now $0·49742 : 3·2 :: 9$ the equivalent of water is to 57·9, which should therefore be the equivalent of tin, if the experiment had been made without error, and if the electro-chemical decomposition *is in this case also definite*. In some chemical works 58 is given as the chemical equivalent of tin, in others 57·9. Both are so near to the result of the experiment, and the experiment itself is so subject to slight causes of variation (as from the absorption of gas in the volta-electrometer (716.), &c.), that the numbers leave little doubt of the applicability of the *law of definite action* in this and all similar cases of electro-decomposition.

792. It is not often I have obtained an accordance in numbers so near as that I have just quoted. Four experiments were made on the protochloride of tin, the quantities of gas evolved in the volta-electrometer being from 2·05 to 10·29 cubic inches. The average of the four experiments gave 58·53 as the electro-chemical equivalent for tin.

793. The chloride remaining after the experiment was pure protochloride of tin; and no one can doubt for a moment that the equivalent of chlorine had been evolved at the *anode*, and, having formed bichloride of tin as a secondary result, had passed away.

794. *Chloride of lead* was experimented upon in a manner exactly similar, except that a change was made in the nature of the positive electrode; for as the chlorine evolved at the *anode* forms no perchloride of lead, but acts directly upon the platina, it produces, if that metal be used, a solution of chloride of platina in the chloride of lead; in consequence of which a portion of platina can pass to the *cathode*, and would then produce a vitiated result. I therefore sought for, and found in plumbago, another substance, which could be used safely as the positive electrode in such bodies as chlorides, iodides, &c.

The chlorine or iodine does not act upon it, but is evolved in the free state; and the plumbago has no re-action, under the circumstances, upon the fused chloride or iodide in which it is plunged. Even if a few particles of plumbago should separate by the heat or the mechanical action of the evolved gas, they can do no harm in the chloride.

795. The mean of three experiments gave the number of 100.85 as the equivalent for lead. The chemical equivalent is 103.5. The deficiency in my experiments I attribute to the solution of part of the gas (716.) in the volta-electrometer; but the results leave no doubt on my mind that both the lead and the chlorine are, in this case, evolved in *definite quantities* by the action of a given quantity of electricity (814. &c.).

796. *Chloride of antimony*.—It was in endeavouring to obtain the electro-chemical equivalent of antimony from the chloride, that I found reasons for the statement I have made respecting the presence of water in it in an earlier part of these Researches (690. 693. &c.).

797. I endeavoured to experiment upon the *oxide of lead* obtained by fusion and ignition of the nitrate in a platina crucible, but found great difficulty, from the high temperature required for perfect fusion, and the powerful fluxing qualities of the substance. Green-glass tubes repeatedly failed. I at last fused the oxide in a small porcelain crucible, heated fully in a charcoal fire; and, as it was essential that the evolution of the lead at the *cathode* should take place beneath the surface, the negative electrode was guarded by a green-glass tube, fused around it in such a manner as to expose only the knob of platina at the lower end (fig. 70.), so that it could be plunged beneath the surface, and thus exclude contact of air or oxygen with the lead reduced there. A platina wire was employed for the positive electrode, that metal not being subject to any action from the oxygen evolved against it. The arrangement is given in fig. 71.

798. In an experiment of this kind the equivalent for the lead came out 93.17, which is very much too small. This, I believe, was because of the small interval between the positive and negative electrodes in the oxide of lead; so that it was not unlikely that some of the froth and bubbles formed by the oxygen at the *anode* should occasionally even touch the lead

reduced at the *cathode*, and re-oxidize it. When I endeavoured to correct this by having more litharge, the greater heat required to keep it all fluid caused a quicker action on the crucible, which was soon eaten through, and the experiment stopped.

799. In one experiment of this kind I used borate of lead (408. 673.). It evolves lead, under the influence of the electric current, at the *anode*, and oxygen at the *cathode*; and as the boracic acid is not either directly (408.) or incidentally decomposed during the operation, I expected a result dependent on the oxide of lead. The borate is not so violent a flux as the oxide, but it requires a higher temperature to make it quite liquid; and if not very hot, the bubbles of oxygen cling to the positive electrode, and retard the transfer of electricity. The number for lead came out 101.29, which is so near to 103.5 as to show that the action of the current had been definite.

800. *Oxide of bismuth*.—I found this substance required too high a temperature, and acted too powerfully as a flux, to allow of any experiment being made on it, without the application of more time and care than I could give at present.

801. The ordinary *protoxide of antimony*, which consists of one proportional of metal and one and a half of oxygen, was subjected to the action of the electric current in a green-glass tube (789.), surrounded by a jacket of platina foil, and heated in a charcoal fire. The decomposition began and proceeded very well at first, apparently indicating, according to the general law (679. 697.), that this substance was one containing such elements and in such proportions as made it amenable to the power of the electric current. This effect I have already given reasons for supposing may be due to the presence of a true protoxide, consisting of single proportionals (696. 693.). The action soon diminished, and finally ceased, because of the formation of a higher oxide of the metal at the positive electrode. This compound, which was probably the peroxide, being infusible and insoluble in the protoxide, formed a crystalline crust around the positive electrode; and thus insulating it, prevented the transmission of the electricity. Whether, if it had been fusible and still immiscible, it would have decomposed, is doubtful, because of its departure from the required composition

(697.). It was a very natural secondary product at the positive electrode (779.). On opening the tube it was found that a little antimony had been separated at the negative electrode; but the quantity was too small to allow of any quantitative result being obtained*.

802. *Iodide of lead.*—This substance can be experimented with in tubes heated by a spirit-lamp (789.); but I obtained no good results from it, whether I used positive electrodes of platinum or plumbago. In two experiments the numbers for the lead came out only 75·46 and 73·45, instead of 103·5. This I attribute to the formation of a periodide at the positive electrode, which, dissolving in the mass of liquid iodide, came in contact with the lead evolved at the negative electrode, and dissolved part of it, becoming itself again protiodide. Such a periodide does exist; and it is very rarely that the iodide of lead formed by precipitation, and well washed, can be fused without evolving much iodine, from the presence of this percompound; nor does crystallization from its hot aqueous solution free it from this substance. Even when a little of the protiodide and iodine are merely rubbed together in a mortar, a portion of the periodide is formed. And though it is decomposed by being fused and heated to dull redness for a few minutes, and the whole reduced to protiodide, yet that is not at all opposed to the possibility, that a little of that which is formed in great excess of iodine at the *anode*, should be carried by the rapid currents in the liquid into contact with the *cathode*.

803. This view of the result was strengthened by a third experiment, where the space between the electrodes was increased to one third of an inch; for now the interfering effects were much diminished, and the number for the lead came out 89·04; and it was fully confirmed by the results obtained in the cases of *transfer* to be immediately described (818.).

The experiments on iodide of lead therefore offer no exception to the *general law* under consideration, but on the contrary may, from general considerations, be admitted as included in it.

804. *Protiodide of tin.*—This substance, when fused (402.),

* This paragraph is subject to the corrective note now appended to paragraph 696.—Dec. 1838.

conducts and is decomposed by the electric current, tin is evolved at the *anode*, and periodide of tin as a secondary result (779. 790.) at the *cathode*. The temperature required for its fusion is too high to allow of the production of any results fit for weighing.

805. *Iodide of potassium* was subjected to electrolytic action in a tube, like that in fig. 68. (789.). The negative electrode was a globule of lead, and I hoped in this way to retain the potassium, and obtain results that could be weighed and compared with the volta-electrometer indication; but the difficulties dependent upon the high temperature required, the action upon the glass, the fusibility of the platina induced by the presence of the lead, and other circumstances, prevented me from procuring such results. The iodide was decomposed with the evolution of iodine at the *anode*, and of potassium at the *cathode*, as in former cases.

806. In some of these experiments several substances were placed in succession, and decomposed simultaneously by the same electric current: thus, protochloride of tin, chloride of lead, and water, were thus acted on at once. It is needless to say that the results were comparable, the tin, lead, chlorine, oxygen, and hydrogen evolved being *definite in quantity* and electro-chemical equivalents to each other.

807. Let us turn to another kind of proof of the *definite chemical action of electricity*. If any circumstances could be supposed to exert an influence over the quantity of the matters evolved during electrolytic action, one would expect them to be present when electrodes of different substances, and possessing very different chemical affinities for such matters, were used. Platina has no power in dilute sulphuric acid of combining with the oxygen at the *anode*, though the latter be evolved in the nascent state against it. Copper, on the other hand, immediately unites with the oxygen, as the electric current sets it free from the hydrogen; and zinc is not only able to combine with it, but can, without any help from the electricity, abstract it directly from the water, at the same time setting torrents of hydrogen free. Yet in cases where these three substances were used as the positive electrodes in three similar portions of the same dilute sulphuric acid, specific gravity 1.336 pre-

cisely the same quantity of water was decomposed by the electric current, and precisely the same quantity of hydrogen set free at the *cathodes* of the three solutions.

808. The experiment was made thus. Portions of the dilute sulphuric acid were put into three basins. Three volta-electrometer tubes, of the form figg. 60. 62. were filled with the same acid, and one inverted in each basin (707.). A zinc plate, connected with the positive end of a voltaic battery, was dipped into the first basin, forming the positive electrode there, the hydrogen, which was abundantly evolved from it by the direct action of the acid, being allowed to escape. A copper plate, which dipped into the acid of the second basin, was connected with the negative electrode of the *first* basin; and a platina plate, which dipped into the acid of the third basin, was connected with the negative electrode of the *second* basin. The negative electrode of the third basin was connected with a volta-electrometer (711.), and that with the negative end of the voltaic battery.

809. Immediately that the circuit was complete, the *electro-chemical action* commenced in all the vessels. The hydrogen still rose in, apparently, undiminished quantities from the positive zinc electrode in the first basin. No oxygen was evolved at the positive copper electrode in the second basin, but a sulphate of copper was formed there; whilst in the third basin the positive platina electrode evolved pure oxygen gas, and was itself unaffected. But in *all* the basins the hydrogen liberated at the *negative* platina electrodes was the *same in quantity*, and the same with the volume of hydrogen evolved in the volta-electrometer, showing that in all the vessels the current had decomposed an equal quantity of water. In this trying case, therefore, the *chemical action of electricity* proved to be *perfectly definite*.

810. A similar experiment was made with muriatic acid diluted with its bulk of water. The three positive electrodes were zinc, silver, and platina; the first being able to separate and combine with the chlorine *without* the aid of the current; the second combining with the chlorine only after the current had set it free; and the third rejecting almost the whole of it. The three negative electrodes were, as before, platina plates fixed within glass tubes. In this experiment, as in the former, the

quantity of hydrogen evolved at the *cathodes* was the same for all, and the same as the hydrogen evolved in the volta-electrometer. I have already given my reasons for believing that in these experiments it is the muriatic acid which is directly decomposed by the electricity (764.); and the results prove that the quantities so decomposed are *perfectly definite* and proportionate to the quantity of electricity which has passed.

811. In this experiment the chloride of silver formed in the second basin retarded the passage of the current of electricity, by virtue of the law of conduction before described (394.), so that it had to be cleaned off four or five times during the course of the experiment; but this caused no difference between the results of that vessel and the others.

812. Charcoal was used as the positive electrode in both sulphuric and muriatic acids (808. 810.); but this change produced no variation of the results. A zinc positive electrode, in sulphate of soda or solution of common salt, gave the same constancy of operation.

813. Experiments of a similar kind were then made with bodies altogether in a different state, *i. e.* with *fused* chlorides, iodides, &c. I have already described an experiment with fused chloride of silver, in which the electrodes were of metallic silver, the one rendered negative becoming increased and lengthened by the addition of metal, whilst the other was dissolved and eaten away by its abstraction. This experiment was repeated, two weighed pieces of silver wire being used as the electrodes, and a volta-electrometer included in the circuit. Great care was taken to withdraw the negative electrode so regularly and steadily that the crystals of reduced silver should not form a *metallic* communication beneath the surface of the fused chloride. On concluding the experiment the positive electrode was re-weighed, and its loss ascertained. The mixture of chloride of silver, and metal, withdrawn in successive portions at the negative electrode, was digested in solution of ammonia, to remove the chloride, and the metallic silver remaining also weighed: it was the reduction at the *cathode*, and exactly equalled the solution at the *anode*; and each portion was as nearly as possible the equivalent to the water decomposed in the volta-electrometer.

814. The infusible condition of the silver at the temperature

used, and the length and ramifying character of its crystals, render the above experiment difficult to perform, and uncertain in its results. I therefore wrought with chloride of lead, using a green-glass tube, formed as in fig. 72. A weighed platina wire was fused into the bottom of a small tube, as before described (789.). The tube was then bent to an angle, at about half an inch distance from the closed end; and the part between the angle and the extremity being softened, was forced upward, as in the figure, so as to form a bridge, or rather separation, producing two little depressions or basins *a*, *b*, within the tube. This arrangement was suspended by a platina wire, as before, so that the heat of a spirit-lamp could be applied to it, such inclination being given to it as would allow all air to escape during the fusion of the chloride of lead. A positive electrode was then provided, by bending up the end of a platina wire into a knot, and fusing about twenty grains of metallic lead on to it, in a small closed tube of glass, which was afterwards broken away. Being so furnished, the wire with its lead was weighed, and the weight recorded.

815. Chloride of lead was now introduced into the tube, and carefully fused. The leaded electrode was also introduced; after which the metal, at its extremity, soon melted. In this state of things the tube was filled up to *c* with melted chloride of lead; the end of the electrode to be rendered negative was in the basin *b*, and, the electrode of melted lead was retained in the basin *a*, and, by connexion with the proper conducting wire of a voltaic battery, was rendered positive. A volta-electrometer was included in the circuit.

816. Immediately upon the completion of the communication with the voltaic battery, the current passed, and decomposition proceeded. No chlorine was evolved at the positive electrode; but as the fused chloride was transparent, a button of alloy could be observed gradually forming and increasing in size at *b*, whilst the lead at *a* could also be seen gradually to diminish. After a time, the experiment was stopped; the tube allowed to cool, and broken open; the wires, with their buttons, cleaned and weighed; and their change in weight compared with the indication of the volta-electrometer.

817. In this experiment the positive electrode had lost just as much lead as the negative one had gained (795.), and the

loss and gain were very nearly the equivalents of the water decomposed in the volta-electrometer, giving for lead the number 101.5. It is therefore evident, in this instance, that causing a *strong affinity*, or *no affinity*, for the substance evolved at the *anode*, to be active during the experiment (807.), produces no variation in the definite action of the electric current.

818. A similar experiment was then made with iodide of lead, and in this manner all confusion from the formation of a periodide avoided (803.). No iodine was evolved during the whole action, and finally the loss of lead at the *anode* was the same as the gain at the *cathode*, the equivalent number, by comparison with the result in the volta-electrometer, being 103.5.

819. Then protochloride of tin was subjected to the electric current in the same manner, using of course, a tin positive electrode. No bichloride of tin was now formed (779. 790.). On examining the two electrodes, the positive had lost precisely as much as the negative had gained; and by comparison with the volta-electrometer, the number for tin came out 59.

820. It is quite necessary in these and similar experiments to examine the interior of the bulbs of alloy at the ends of the conducting wires; for occasionally, and especially with those which have been positive, they are cavernous, and contain portions of the chloride or iodide used, which must be removed before the final weight is ascertained. This is more usually the case with lead than tin.

821. All these facts combine into, I think, an irresistible mass of evidence, proving the truth of the important proposition which I at first laid down, namely, *that the chemical power of a current of electricity is in direct proportion to the absolute quantity of electricity which passes* (377. 783.). They prove, too, that this is not merely true with one substance, as water, but generally with all electrolytic bodies; and, further, that the results obtained with any *one substance* do not merely agree amongst themselves, but also with those obtained from *other substances*, the whole combining together into *one series of definite electro-chemical actions* (505.). I do not mean to say that no exceptions will appear: perhaps some may arise, especially amongst substances existing only by weak affinity; but I do not expect that any will seriously disturb the result announced. If, in the well considered, well examined, and, I

may surely say, well ascertained doctrines of the definite nature of ordinary chemical affinity, such exceptions occur, as they do in abundance, yet, without being allowed to disturb our minds as to the general conclusion, they ought also to be allowed if they should present themselves at this, the opening of a new view of electro-chemical action; not being held up as obstructions to those who may be engaged in rendering that view more and more perfect, but laid aside for a while, in hopes that their perfect and consistent explanation will ultimately appear.

822. The doctrine of *definite electro-chemical action* just laid down, and, I believe, established, leads to some new views of the relations and classifications of bodies associated with or subject to this action. Some of these I shall proceed to consider.

823. In the first place, compound bodies may be separated into two great classes, namely, those which are decomposable by the electric current, and those which are not: of the latter, some are conductors, others non-conductors, of voltaic electricity*. The former do not depend for their decomposability upon the nature of their elements only; for, of the same two elements, bodies may be formed, of which one shall belong to one class and another to the other class; but probably on the proportions also (697.). It is further remarkable, that with very few, if any, exceptions (414. 691.), these decomposable bodies are exactly those governed by the remarkable law of conduction I have before described (394.); for that law does not extend to the many compound fusible substances that are excluded from this class. I propose to call bodies of this, the decomposable class, *Electrolytes* (664.).

824. Then, again, the substances into which these divide, under the influence of the electric current, form an exceedingly important general class. They are combining bodies; are directly associated with the fundamental parts of the doctrine of chemical affinity; and have each a definite proportion, in which they are always evolved during electrolytic action. I have proposed to call these bodies generally *ions*, or particularly *anions* and

* I mean here by voltaic electricity, merely electricity from a most abundant source, but having very small intensity.

cations, according as they appear at the *anode* or *cathode* (665.); and the numbers representing the proportions in which they are evolved *electro-chemical equivalents*. Thus hydrogen, oxygen, chlorine, iodine, lead, tin are *ions*; the three former are *anions*, the two metals are *cations*, and 1, 8, 36, 125, 104, 58, are their *electro-chemical equivalents* nearly.

825. A summary of certain points already ascertained respecting *electrolytes*, *ions*, and *electro-chemical equivalents*, may be given in the following general form of propositions, without, I hope, including any serious error.

826. i. A single *ion*, *i. e.* one not in combination with another, will have no tendency to pass to either of the electrodes, and will be perfectly indifferent to the passing current, unless it be itself a compound of more elementary *ions*, and so subject to actual decomposition. Upon this fact is founded much of the proof adduced in favour of the new theory of electro-chemical decomposition, which I put forth in a former series of these Researches (518. &c.).

827. ii. If one *ion* be combined in right proportions (697.) with another strongly opposed to it in its ordinary chemical relations, *i. e.* if an *anion* be combined with a *cation*, then both will travel, the one to the *anode*, the other to the *cathode*, of the decomposing body (530. 542. 547.).

828. iii. If, therefore, an *ion* pass towards one of the electrodes, another *ion* must also be passing simultaneously to the other electrode, although, from secondary action, it may not make its appearance (743.).

829. iv. A body decomposable directly by the electric current, *i. e.* an *electrolyte*, must consist of two *ions*, and must also render them up during the act of decomposition.

830. v. There is but one *electrolyte* composed of the same two elementary *ions*; at least such appears to be the fact (697.), dependent upon a law, that *only single electro-chemical equivalents of elementary ions can go to the electrodes, and not multiples*.

831. vi. A body not decomposable when alone, as boracic acid, is not directly decomposable by the electric current when in combination (780.). It may act as an *ion* going wholly to the *anode* or *cathode*, but does not yield up its elements, except occasionally by a secondary action. Perhaps it superfluous for me to point out that this proposition has *no relation* to such

eases as that of water, which, by the presence of other bodies, is rendered a better conductor of electricity, and *therefore* is more freely decomposed.

832. vii. The nature of the substance of which the electrode is formed, provided it be a conductor, causes no difference in the electro-decomposition, either in kind or degree (807. 813.) : but it seriously influences, by secondary action (744.), the state in which the *ions* finally appear. Advantage may be taken of this principle in combining and collecting such *ions* as, if evolved in their free state, would be unmanageable*.

833. viii. A substance which, being used as the electrode, can combine with the *ion* evolved against it, is also, I believe, an *ion*, and combines, in such cases, in the quantity represented by its *electro-chemical equivalent*. All the experiments I have made agree with this view ; and it seems to me, at present, to result as a necessary consequence. Whether, in the secondary actions that take place, where the *ion* acts, not upon the matter of the electrode, but on that which is around it in the liquid (744.), the same consequence follows, will require more extended investigation to determine.

834. ix. Compound *ions* are not necessarily composed of electro-chemical equivalents of simple *ions*. For instance, sulphuric acid, boracic acid, phosphoric acid, are *ions*, but not *electrolytes*, *i. e.* not composed of electro-chemical equivalents of simple *ions*.

835. x. Electro-chemical equivalents are always consistent ; *i. e.* the same number which represents the equivalent of a substance A when it is separating from a substance B, will also represent A when separating from a third substance C. Thus, 8 is the electro-chemical equivalent of oxygen, whether separating from hydrogen, or tin, or lead ; and 103.5 is the electro-chemical equivalent of lead, whether separating from oxygen, or chlorine, or iodine.

* It will often happen that the electrodes used may be of such a nature as, with the fluid in which they are immersed, to produce an electric current, either according with or opposing that of the voltaic arrangement used, and in this way, or by direct chemical action, may sadly disturb the results. Still, in the midst of all these confusing effects, the electric current, which actually passes in any direction through the body suffering decomposition, will produce its own definite electrolytic action.

836. xi. Electro-chemical equivalents coincide, and are the same, with ordinary chemical equivalents.

837. By means of experiment and the preceding propositions, a knowledge of *ions* and their electro-chemical equivalents may be obtained in various ways.

838. In the first place, they may be determined directly, as has been done with hydrogen, oxygen, lead, and tin, in the numerous experiments already quoted.

839. In the next place, from propositions ii. and iii., may be deduced the knowledge of many other *ions*, and also their equivalents. When chloride of lead was decomposed, platina being used for both electrodes (395.), there could remain no more doubt that chlorine was passing to the *anode*, although it combined with the platina there, than when the positive electrode, being of plumbago (794.), allowed its evolution in the free state; neither could there, in either case, remain any doubt that for every 103.5 parts of lead evolved at the *cathode*, 36 parts of chlorine were evolved at the *anode*, for the remaining chloride of lead was unchanged. So also, when in a metallic solution one volume of oxygen, or a secondary compound containing that proportion, appeared at the *anode*, no doubt could arise that hydrogen, equivalent to two volumes, had been determined to the *cathode*, although, by a secondary action, it had been employed in reducing oxides of lead, copper, or other metals, to the metallic state. In this manner, then, we learn from the experiments already described in these Researches, that chlorine, iodine, bromine, fluorine, calcium, potassium, strontium, magnesium, manganese, &c., are *ions*, and that their *electro-chemical equivalents* are the same as their *ordinary chemical equivalents*.

840. Propositions iv. and v. extend our means of gaining information. For if a body of known chemical composition is found to be decomposable, and the nature of the substance evolved as a primary or even a secondary result (743. 777.) at one of the electrodes, be ascertained, the electro-chemical equivalent of that body may be deduced from the known constant composition of the substance evolved. Thus, when fused protiodide of tin is decomposed by the voltaic current (804.), the conclusion may be drawn, that both the iodine and tin are *ions*, and that the proportions in which they come in the

fused compound express their electro-chemical equivalents. Again, with respect to the fused iodide of potassium (805.), it is an electrolyte; and the chemical equivalents will also be the electro-chemical equivalents.

841. If proposition viii. sustain extensive experimental investigation, then it will not only help to confirm the results obtained by the use of the other propositions, but will give abundant original information of its own.

842. In many instances, the *secondary results* obtained by the action of the evolved *ion* on the substances present in the surrounding liquid or solution, will give the electro-chemical equivalent. Thus, in the solution of acetate of lead, and, as far as I have gone, in other proto-salts subjected to the reducing action of the nascent hydrogen at the *cathode*, the metal precipitated has been in the same quantity as if it had been a primary product, (provided no free hydrogen escaped there,) and therefore gave accurately the number representing its electro-chemical equivalent.

843. Upon this principle it is that secondary results may occasionally be used as measurers of the volta-electric current (706. 740.); but there are not many metallic solutions that answer this purpose well: for unless the metal is easily precipitated, hydrogen will be evolved at the *cathode* and vitiate the result. If a soluble peroxide is formed at the *anode*, or if the precipitated metal crystallize across the solution and touch the positive electrode, similar vitiated results are obtained. I expect to find in some salts, as the acetates of mercury and zinc, solutions favourable for this use.

844. After the first experimental investigations to establish the definite chemical action of electricity, I have not hesitated to apply the more strict results of chemical analysis to correct the numbers obtained as electrolytic results. This, it is evident, may be done in a great number of cases, without using too much liberty towards the due severity of scientific research. The series of numbers representing electro-chemical equivalents must, like those expressing the ordinary equivalents of chemically acting bodies, remain subject to the continual correction of experiment and sound reasoning.

845. I give the following brief Table of *ions* and their electro-chemical equivalents, rather as a specimen of a first attempt

than as anything that can supply the want which must very quickly be felt, of a full and complete tabular account of this class of bodies. Looking forward to such a table as of extreme utility (if well constructed) in developing the intimate relation of ordinary chemical affinity to electrical actions, and identifying the two, not to the imagination merely, but to the conviction of the senses and a sound judgement, I may be allowed to express a hope, that the endeavour will always be to make it a table of *real*, and not *hypothetical*, electro-chemical equivalents; for we shall else overrun the facts, and lose all sight and consciousness of the knowledge lying directly in our path.

846. The equivalent numbers do not profess to be exact, and are taken almost entirely from the chemical results of other philosophers in whom I could repose more confidence, as to these points, than in myself.

847. TABLE OF IONS.

Anions.

Oxygen	8	Selenic acid	64	Tartaric acid	66
Chlorine	35.5	Nitric acid	54	Citric acid	58
Iodine	126	Chloric acid	75.5	Oxalic acid	36
Bromine	78.3	Phosphoric acid. . .	35.7	Sulphur (?)	16
Fluorine	18.7	Carbonic acid. . . .	22	Selenium (?)	
Cyanogen	26	Boracic acid	24	Sulpho-cyanogen	
Sulphuric acid . . .	40	Acetic acid	51		

Cations.

Hydrogen	1	Cadmium	55.8	Soda	31.3
Potassium	39.2	Cerium	46	Lithia	18
Sodium	23.3	Cobalt	29.5	Baryta	76.7
Lithium	10	Nickel	29.5	Strontia	51.8
Barium	68.7	Antimony	64.6?	Lime	28
Strontium	43.8	Bismuth	71	Magnesia	20.7
Calcium	20.5	Mercury	200	Alumina	(?)
Magnesium	12.7	Silver	108	Protoxides generally.	
Manganese	27.7	Platina	98.6?	Quinia	171.6
Zinc	32.5	Gold	(?)	Cinchona	160
Tin	57.9			Morphia	290
Lead	103.5	Ammonia	17	Vegeto-alkalies gene-	
Iron	28	Potassa	47.2	rally.	
Copper	31.6				

848. This Table might be further arranged into groups of such substances as either act with, or replace, each other. Thus, for instance, acids and bases act in relation to each

other; but they do not act in association with oxygen, hydrogen, or elementary substances. There is indeed little or no doubt that, when the electrical relations of the particles of matter come to be closely examined, this division must be made. The simple substances, with cyanogen, sulpho-cyanogen, and one or two other compound bodies, will probably form the first group; and the acids and bases, with such analogous compounds as may prove to be *ions*, the second group. Whether these will include all *ions*, or whether a third class of more complicated results will be required, must be decided by future experiments.

849. It is *probable* that all our present elementary bodies are *ions*, but that is not as yet certain. There are some, such as carbon, phosphorus, nitrogen, silicon, boron, aluminium, the right of which to the title of *ion* it is desirable to decide as soon as possible. There are also many compound bodies, and amongst them alumina and silica, which it is desirable to class immediately by unexceptionable experiments. It is also *possible*, that all combinable bodies, compound as well as simple, may enter into the class of *ions*; but at present it does not seem to me probable. Still the experimental evidence I have is so small in proportion to what must gradually accumulate around, and bear upon, this point, that I am afraid to give a strong opinion upon it.

850. I think I cannot deceive myself in considering the doctrine of definite electro-chemical action as of the utmost importance. It touches by its facts more directly and closely than any former fact, or set of facts, have done, upon the beautiful idea, that ordinary chemical affinity is a mere consequence of the electrical attractions of the particles of different kinds of matter; and it will probably lead us to the means by which we may enlighten that which is at present so obscure, and either fully demonstrate the truth of the idea, or develop that which ought to replace it.

851. A very valuable use of electro-chemical equivalents will be to decide, in cases of doubt, what is the true chemical equivalent, or definite proportional, or atomic number of a body; for I have such conviction that the power which governs electro-decomposition and ordinary chemical attractions is the same; and such confidence in the overruling influence of those natu-

ral laws which render the former definite, as to feel no hesitation in believing that the latter must submit to them also. Such being the case, I can have no doubt that, assuming hydrogen as 1, and dismissing small fractions for the simplicity of expression, the equivalent number or atomic weight of oxygen is 8, of chlorine 36, of bromine 78.4, of lead 103.5, of tin 59, &c., notwithstanding that a very high authority doubles several of these numbers.

§ 13. *On the absolute quantity of Electricity associated with the particles or atoms of Matter.*

852. The theory of definite electrolytical or electro-chemical action appears to me to touch immediately upon the *absolute quantity* of electricity or electric power belonging to different bodies. It is impossible, perhaps, to speak on this point without committing oneself beyond what present facts will sustain; and yet it is equally impossible, and perhaps would be impolitic, not to reason upon the subject. Although we know nothing of what an atom is, yet we cannot resist forming some idea of a small particle, which represents it to the mind; and though we are in equal, if not greater, ignorance of electricity, so as to be unable to say whether it is a particular matter or matters, or mere motion of ordinary matter, or some third kind of power or agent, yet there is an immensity of facts which justify us in believing that the atoms of matter are in some way endowed or associated with electrical powers, to which they owe their most striking qualities, and amongst them their mutual chemical affinity. As soon as we perceive, through the teaching of Dalton, that chemical powers are, however, varied the circumstances in which they are exerted, definite for each body, we learn to estimate the relative degree of force which resides in such bodies: and when upon that knowledge comes the fact, that the electricity, which we appear to be capable of loosening from its habitation for a while, and conveying from place to place, *whilst it retains its chemical force*, can be measured out, and being so measured is found to be *as definite in its action* as any of *those portions* which, remaining associated with the particles of matter, give them their *chemical relation*; we seem to have found the link which connects the pro-

portion of that we have evolved to the proportion of that belonging to the particles in their natural state.

853. Now it is wonderful to observe how small a quantity of a compound body is decomposed by a certain portion of electricity. Let us, for instance, consider this and a few other points in relation to water. *One grain* of water, acidulated to facilitate conduction, will require an electric current to be continued for three minutes and three quarters of time to effect its decomposition, which current must be powerful enough to retain a platina wire $\frac{1}{104}$ of an inch in thickness*, red hot, in the air during the whole time; and if interrupted anywhere by charcoal points, will produce a very brilliant and constant star of light. If attention be paid to the instantaneous discharge of electricity of tension, as illustrated in the beautiful experiments of Mr. Wheatstone†, and to what I have said elsewhere on the relation of common and voltaic electricity (371. 375.), it will not be too much to say that this necessary quantity of electricity is equal to a very powerful flash of lightning. Yet we have it under perfect command; can evolve, direct, and employ it at pleasure; and when it has performed its full work of electrolyzation, it has only separated the elements of *a single grain of water*.

854. On the other hand, the relation between the conduction of the electricity and the decomposition of the water is so close, that one cannot take place without the other. If the water is altered only in that small degree which consists in its having

* I have not stated the length of wire used, because I find by experiment, as would be expected in theory, that it is indifferent. The same quantity of electricity which, passed in a given time, can heat an inch of platina wire of a certain diameter red hot, can also heat a hundred, a thousand, or any length of the same wire to the same degree, provided the cooling circumstances are the same for every part in all cases. This I have proved by the volta-electrometer. I found that whether half an inch or eight inches were retained at one constant temperature of dull redness, equal quantities of water were decomposed in equal times. When the half-inch was used, only the centre portion of wire was ignited. A fine wire may even be used as a rough but ready regulator of a voltaic current; for if it be made part of the circuit, and the larger wires communicating with it be shifted nearer to or further apart, so as to keep the portion of wire in the circuit sensibly at the same temperature, the current passing through it will be nearly uniform.

† Literary Gazette, 1833, March 1 and 8. Philosophical Magazine, 1833, p. 204. L'Institute, 1833, p. 261.

the solid instead of the fluid state, the conduction is stopped, and the decomposition is stopped with it. Whether the conduction be considered as depending upon the decomposition, or not (413. 703.), still the relation of the two functions is equally intimate and inseparable.

855. Considering this close and twofold relation, namely, that without decomposition transmission of electricity does not occur; and, that for a given definite quantity of electricity passed, an equally definite and constant quantity of water or other matter is decomposed; considering also that the agent, which is electricity, is simply employed in overcoming electrical powers in the body subjected to its action; it seems a probable, and almost a natural consequence, that the quantity which passes is the *equivalent* of, and therefore equal to, that of the particles separated; *i. e.* that if the electrical power which holds the elements of a grain of water in combination, or which makes a grain of oxygen and hydrogen in the right proportions unite into water when they are made to combine, could be thrown into the condition of *a current*, it would exactly equal the current required for the separation of that grain of water into its elements again.

856. This view of the subject gives an almost overwhelming idea of the extraordinary quantity or degree of electric power which naturally belongs to the particles of matter; but it is not inconsistent in the slightest degree with the facts which can be brought to bear on this point. To illustrate this I must say a few words on the voltaic pile*.

857. Intending hereafter to apply the results given in this and the preceding series of Researches to a close investigation of the source of electricity in the voltaic instrument, I have refrained from forming any decided opinion on the subject; and without at all meaning to dismiss metallic contact, or the contact of dissimilar substances, being conductors, but not metallic, as if they had nothing to do with the origin of the current,

* By the term voltaic pile, I mean such apparatus or arrangement of metals as up to this time have been called so, and which contain water, brine, acids, or other aqueous solutions or decomposable substances (476.), between their plates. Other kinds of electric apparatus may be hereafter invented, and I hope to construct some not belonging to the class of instruments discovered by Volta.

I still am fully of opinion with Davy, that it is at least continued by chemical action, and that the supply constituting the current is almost entirely from that source.

858. Those bodies which, being interposed between the metals of the voltaic pile, render it active, *are all of them electrolytes* (476.); and it cannot but press upon the attention of every one engaged in considering this subject, that in those bodies (so essential to the pile) decomposition and the transmission of a current are so intimately connected, that one cannot happen without the other. This I have shown abundantly in water, and numerous other cases (402. 476.). If, then, a voltaic trough have its extremities connected by a body capable of being decomposed, as water, we shall have a continuous current through the apparatus; and whilst it remains in this state we may look at the part where the acid is acting upon the plates, and that where the current is acting upon the water, as the reciprocals of each other. In both parts we have the two conditions *inseparable in such bodies as these*, namely, the passing of the current, and decomposition; and this is as true of the cells in the battery as of the water cell; for no voltaic battery has as yet been constructed in which the chemical action is only that of combination: *decomposition is always included*, and is, I believe, an essential chemical part.

859. But the difference in the two parts of the connected battery, that is, the decomposition or experimental cell, and the acting cells, is simply this. In the former we urge the current through, but it, apparently of necessity, is accompanied by decomposition: in the latter we cause decompositions by ordinary chemical actions, (which are, however, themselves electrical,) and, as a consequence, have the electrical current; and as the decomposition dependent upon the current is definite in the former case, so is the current associated with the decomposition also definite in the latter (862. &c.).

860. Let us apply this in support of what I have surmised respecting the enormous electric power of each particle or atom of matter (856.). I showed in a former series of these Researches on the relation by measure of common and voltaic electricity, that two wires, one of platina and one of zinc, each one eighteenth of an inch in diameter, placed five sixteenths of an inch apart, and immersed to the depth of five

eighths of an inch in acid, consisting of one drop of oil of vitriol and four ounces of distilled water at a temperature of about 60° Fahr., and connected at the other extremities by a copper wire eighteen feet long, and one eighteenth of an inch in thickness, yielded as much electricity in little more than three seconds of time as a Leyden battery charged by thirty turns of a very large and powerful plate electric machine in full action (371.). This quantity, though sufficient if passed at once through the head of a rat or cat to have killed it, as by a flash of lightning, was evolved by the mutual action of so small a portion of the zinc wire and water in contact with it, that the loss of weight sustained by either would be inappreciable by our most delicate instruments; and as to the water which could be decomposed by that current, it must have been insensible in quantity, for no trace of hydrogen appeared upon the surface of the platina during those three seconds.

861. What an enormous quantity of electricity, therefore, is required for the decomposition of a single grain of water! We have already seen that it must be in quantity sufficient to sustain a platina wire $\frac{1}{104}$ of an inch in thickness, red hot, in contact with the air, for three minutes and three quarters (853.), a quantity which is almost infinitely greater than that which could be evolved by the little standard voltaic arrangement to which I have just referred (860. 371.). I have endeavoured to make a comparison by the loss of weight of such a wire in a given time in such an acid, according to a principle and experiment to be almost immediately described (862.); but the proportion is so high that I am almost afraid to mention it. It would appear that 800,000 such charges of the Leyden battery as I have referred to above, would be necessary to supply electricity sufficient to decompose a single grain of water; or, if I am right, to equal the quantity of electricity which is naturally associated with the elements of that grain of water, endowing them with their mutual chemical affinity.

862. In further proof of this high electric condition of the particles of matter, and the *identity as to quantity of that belonging to them with that necessary for their separation*, I will describe an experiment of great simplicity but extreme beauty, when viewed in relation to the evolution of an electric current and its decomposing powers.

863. A dilute sulphuric acid, made by adding about one part by measure of oil of vitriol to thirty parts of water, will act energetically upon a piece of zinc plate in its ordinary and simple state: but, as Mr. Sturgeon has shewn*, not at all, or scarcely so, if the surface of the metal has in the first instance been amalgamated; yet the amalgamated zinc will act powerfully with platina as an electrometer, hydrogen being evolved on the surface of the latter metal, as the zinc is oxidized and dissolved. The amalgamation is best effected by sprinkling a few drops of mercury upon the surface of the zinc, the latter being moistened with the dilute acid, and rubbing with the fingers or tow so as to extend the liquid metal over the whole of the surface. Any mercury in excess, forming liquid drops upon the zinc, should be wiped off†.

864. Two plates of zinc thus amalgamated were dried and accurately weighed; one, which we will call A, weighed 163·1 grains; the other to be called B, weighed 148·3 grains. They were about five inches long, and 0·4 of an inch wide. An earthenware pneumatic trough was filled with dilute sulphuric acid, of the strength just described (863.), and a gas jar, also filled with the acid, inverted in it‡. A plate of platina of nearly the same length, but about three times as wide as the zinc plates, was put up into this jar. The zinc plate A was also introduced into the jar, and brought in contact with the platina, and at the same moment the plate B was put into the acid of the trough, but out of contact with other metallic matter.

865. Strong action immediately occurred in the jar upon the contact of the zinc and platina plates. Hydrogen gas rose from the platina, and was collected in the jar, but no hydrogen or other gas rose from *either* zinc plate. In about ten or twelve minutes, sufficient hydrogen having been collected, the experiment was stopped; during its progress a few small bubbles had appeared upon plate B, but none upon plate A. The plates

* Recent Experimental Researches, &c., 1830, p. 74, &c.

† The experiment may be made with pure zinc, which, as chemists well know, is but slightly acted upon by dilute sulphuric acid in comparison with ordinary zinc, which during the action is subject to an infinity of voltaic actions. See De la Rive on this subject, Bibliothèque Universelle, 1830, p. 391.

‡ The acid was left during a night with a small piece of unamalgamated zinc in it, for the purpose of evolving such air as might be inclined to separate, and bringing the whole into a constant state.

were washed in distilled water, dried, and reweighed. Plate B weighed 148·3 grains, as before, having lost nothing by the direct chemical action of the acid. Plate A weighed 154·65 grains, 8·45 grains of it having been oxidized and dissolved during the experiment.

866. The hydrogen gas was next transferred to a water-trough and measured; it amounted to 12·5 cubie inches, the temperature being 52°, and the barometer 29·2 inches. This quantity, corrected for temperature, pressure, and moisture, becomes 12·15453 cubie inches of dry hydrogen at mean temperature and pressure; which, increased by one half for the oxygen that must have gone to the *anode*, *i.e.* to the zinc, gives 18·232 cubie inches as the quantity of oxygen and hydrogen evolved from the water decomposed by the electric current. According to the estimate of the weight of the mixed gas before adopted (791.), this volume is equal to 2·3535544 grains, which therefore is the weight of water decomposed; and this quantity is to 8·45, the quantity of zinc oxidized, as 9 is to 32·31. Now taking 9 as the equivalent number of water, the number 32·5 is given as the equivalent number of zinc; a coincidence sufficiently near to show, what indeed could not but happen, that for an equivalent of zinc oxidized an equivalent of water must be decomposed*.

867. But let us observe *how* the water is decomposed. It is electrolyzed, *i.e.* is decomposed voltaically, and not in the ordinary manner (as to appearance) of chemical decompositions; for the oxygen appears at the *anode* and the hydrogen at the *cathode* of the body under decomposition, and these were in many parts of the experiment above an inch asunder. Again, the ordinary chemical affinity was not enough under the circumstances to effect the decomposition of the water, as was abundantly proved by the inaction on plate B; the voltaic current was essential. And to prevent any idea that the chemical affinity was almost sufficient to decompose the water, and that a smaller current of electricity might under the circumstances, cause the hydrogen to pass to the *cathode*, I need only refer to the results which I have given (807. 813.) to show that the chemical action at the electrodes has not the slightest influence over the *quantities* of water or other substances decomposed between them, but

* The experiment was repeated several times with the same results.

that they are entirely dependent upon the quantity of electricity which passes.

868. What, then, follows as a necessary consequence of the whole experiment? Why, this: that the chemical action upon 32.31 parts, or one equivalent of zinc, in this simple voltaic circle, was able to evolve such quantity of electricity in the form of a current, as passing through water, should decompose 9 parts, or one equivalent of that substance: and considering the definite relations of electricity as developed in the preceding parts of the present paper, the results prove that the quantity of electricity which, being naturally associated with the particles of matter, gives them their combining power, is able, when thrown into a current, to separate those particles from their state of combination; or, in other words, that *the electricity which decomposes, and that which is evolved by the decomposition of, a certain quantity of matter, are alike.*

869. The harmony which this theory of the definite evolution and the equivalent definite action of electricity introduces into the associated theories of definite proportions and electro-chemical affinity, is very great. According to it, the equivalent weights of bodies are simply those quantities of them which contain equal quantities of electricity, or have naturally equal electric powers; it being the ELECTRICITY which *determines* the equivalent number, *because* it determines the combining force. Or, if we adopt the atomic theory or phraseology, then the atoms of bodies which are equivalents to each other in their ordinary chemical action, have equal quantities of electricity naturally associated with them. But I must confess I am jealous of the term *atom*; for though it is very easy to talk of atoms, it is very difficult to form a clear idea of their nature, especially when compound bodies are under consideration.

870. I cannot refrain from recalling here the beautiful idea put forth, I believe, by Berzelius (703.). in his development of his views of the electro-chemical theory of affinity, that the heat and light evolved during eases of powerful combination are the consequence of the electric discharge which is at the moment taking place. The idea is in perfect accordance with the view I have taken of the *quantity* of electricity associated with the particles of matter.

871. In this exposition of the law of the definite action of

electricity, and its corresponding definite proportion in the particles of bodies, I do not pretend to have brought, as yet, every case of chemical or electro-chemical action under its dominion. There are numerous considerations of a theoretical nature, especially respecting the compound particles of matter and the resulting electrical forces which they ought to possess, which I hope will gradually receive their development; and there are numerous experimental cases, as, for instance, those of compounds formed by weak affinities, the simultaneous decomposition of water and salts, &c., which still require investigation. But whatever the results on these and numerous other points may be, I do not believe that the facts which I have advanced, or even the general laws deduced from them, will suffer any serious change; and they are of sufficient importance to justify their publication, though much may yet remain imperfect or undone. Indeed, it is the great beauty of our science, CHEMISTRY, that advancement in it, whether in a degree great or small, instead of exhausting the subjects of research, opens the doors to further and more abundant knowledge, overflowing with beauty and utility, to those who will be at the easy personal pains of undertaking its experimental investigation.

872. The definite production of electricity (868.) in association with its definite action proves, I think, that the current of electricity in the voltaic pile is sustained by chemical decomposition, or rather by chemical action, and not by contact only. But here, as elsewhere (857.), I beg to reserve my opinion as to the real action of contact, not having yet been able to make up my mind as to whether it is an exciting cause of the current, or merely necessary to allow of the conduction of electricity, otherwise generated, from one metal to the other.

873. But admitting that chemical action is the source of electricity, what an infinitely small fraction of that which is active do we obtain and employ in our voltaic batteries! Zinc and platinum wires, one eighteenth of an inch in diameter and about half an inch long, dipped into dilute sulphuric acid, so weak that it is not sensibly sour to the tongue, or scarcely to our most delicate test papers, will evolve more electricity in one twentieth of a minute (860.) than any man would willingly allow to pass through his body at once. The chemical action of a grain of water upon four grains of zinc can evolve electricity

equal in quantity to that of a powerful thunder-storm (868. 861.). Nor is it merely true that the quantity is active; it can be directed and made to perform its full equivalent duty (867. &c.). Is there not, then, great reason to hope and believe that, by a closer *experimental* investigation of the principles which govern the development and action of this subtile agent, we shall be able to increase the power of our batteries, or invent new instruments which shall a thousandfold surpass in energy those which we at present possess?

874. Here for a while I must leave the consideration of the *definite chemical action of electricity*. But before I dismiss this series of experimental Researches, I would call to mind that, in a former series, I showed the current of electricity was also *definite in its magnetic action* (216. 366. 367. 376. 377.); and, though this result was not pursued to any extent, I have no doubt that the success which has attended the development of the chemical effects is not more than would accompany an investigation of the magnetic phenomena.

Royal Institution,
December 31st, 1833.

EIGHTH SERIES.

§ 14. *On the Electricity of the Voltaic Pile ; its source, quantity, intensity, and general characters.* ¶ i. *On simple Voltaic Circles.* ¶ ii. *On the intensity necessary for Electrolyzation.* ¶ iii. *On associated Voltaic Circles, or the Voltaic Battery.* ¶ iv. *On the resistance of an Electrolyte to Electrolytic action.* ¶ v. *General remarks on the active Voltaic Battery.*

Received April 7.—Read June 5, 1834.

¶ i. *On simple Voltaic Circles.*

875. THE great question of the source of electricity in the voltaic pile has engaged the attention of so many eminent philosophers, that a man of liberal mind and able to appreciate their powers would probably conclude, although he might not have studied the question, that the truth was somewhere revealed. But if in pursuance of this impression he were induced to enter upon the work of collating results and conclusions, he would find such contradictory evidence, such equilibrium of opinion, such variation and combination of theory, as would leave him in complete doubt respecting what he should accept as the true interpretation of nature : he would be forced to take upon himself the labour of repeating and examining the facts, and then use his own judgement on them in preference to that of others.

876. This state of the subject must, to those who have made up their minds on the matter, be my apology for entering upon its investigation. The views I have taken of the definite action of electricity in decomposing bodies (783.), and the identity of the power so used with the power to be overcome (855.), founded not on a mere opinion or general notion, but on facts which, being altogether new, were to my mind precise and conclusive, gave me, as I conceived, the power of examining the question with advantages not before possessed by any, and which might compensate, on my part, for the superior clearness and extent

of intellect on theirs. Such are the considerations which have induced me to suppose I might help in deciding the question, and be able to render assistance in that great service of removing *doubtful knowledge*. Such knowledge is the early morning light of every advancing science, and is essential to its development; but the man who is engaged in dispelling that which is deceptive in it, and revealing more clearly that which is true, is as useful in his place, and as necessary to the general progress of the science, as he who first broke through the intellectual darkness, and opened a path into knowledge before unknown to man.

877. The identity of the force constituting the voltaic current or electrolytic agent, with that which holds the elements of electrolytes together (855.), or in other words with chemical affinity, seemed to indicate that the electricity of the pile itself was merely a mode of exertion, or exhibition, or existence of *true chemical action*, or rather of its cause; and I have consequently already said that I agree with those who believe that the *supply* of electricity is due to chemical powers (857.).

878. But the great question of whether it is originally due to metallic contact or to chemical action, *i. e.* whether it is the first or the second which *originates* and determines the current, was to me still doubtful; and the beautiful and simple experiment with amalgamated zinc and platina, which I have described minutely as to its results (863, &c.), did not decide the point; for in that experiment the chemical action does not take place without the contact of the metals, and the metallic contact is inefficient without the chemical action. Hence either might be looked upon as the *determining* cause of the current.

879. I thought it essential to decide this question by the simplest possible forms of apparatus and experiment, that no fallacy might be inadvertently admitted. The well known difficulty of effecting decomposition by a single pair of plates, except in the fluid exciting them into action (863.), seemed to throw insurmountable obstruction in the way of such experiments; but I remembered the easy decomposability of the solution of iodide of potassium (316.) and seeing no theoretical reason, if metallic contact was not *essential*, why true electro-decomposition should not be obtained without it, even in a single circuit, I persevered and succeeded.

880. A plate of zinc, about eight inches long and half an inch wide, was cleaned and bent in the middle to a right angle, fig. 73 *a*. Plate VI. A plate of platina, about three inches long and half an inch wide, was fastened to a platina wire, and the latter bent as in the figure, *b*. These two pieces of metal were arranged together as delineated, but as yet without the vessel *c*, and its contents, which consisted of dilute sulphuric acid mingled with a little nitric acid. At *x* a piece of folded bibulous paper, moistened in a solution of iodide of potassium, was placed on the zinc, and was pressed upon by the end of the platina wire. When under these circumstances the plates were dipped into the acid of the vessel *c*, there was an immediate effect at *x*, the iodide being decomposed, and iodine appearing at the *anode* (663.), *i. e.* against the end of the platina wire.

881. As long as the lower ends of the plates remained in the acid the electric current continued, and the decomposition proceeded at *x*. On removing the end of the wire from place to place on the paper, the effect was evidently very powerful; and on placing a piece of turmeric paper between the white paper and zinc, both papers being moistened with the solution of iodide of potassium, alkali was evolved at the *cathode* (663.) against the zinc, in proportion to the evolution of iodine at the *anode*. Hence the decomposition was perfectly polar, and decidedly dependent upon a current of electricity passing from the zinc through the acid to the platina in the vessel *c*, and back from the platina through the solution to the zinc at the paper *x*.

882. That the decomposition at *x* was a true electrolytic action, due to a current determined by the state of things in the vessel *c*, and not dependent upon any mere direct chemical action of the zinc and platina on the iodide, or even upon any *current* which the solution of iodide might by its action on those metals tend to form at *x*, was shown, in the first place, by removing the vessel *c* and its acid from the plates, when all decomposition at *x* ceased, and in the next by connecting the metals, either in or out of the acid, together, when decomposition of the iodide at *x* occurred, but in a *reverse order*; for now alkali appeared against the end of the platina wire, and the iodine passed to the zinc, the current being the contrary of what it was in the former instance, and produced directly by

the difference of action of the solution in the paper on the two metals. The iodine of course *combined* with the zinc.

883. When this experiment was made with pieces of zinc amalgamated over the whole surface (863.), the results were obtained with equal facility and in the same direction, even when only dilute sulphuric acid was contained in the vessel *c* (fig. 73.). Whichever end of the zinc was immersed in the acid, still the effects were the same: so that if, for a moment, the mercury might be supposed to supply the metallic contact, the inversion of the amalgamated piece destroys that objection. The use of *unamalgamated zinc* (880.) removes all possibility of doubt*.

884. When, in pursuance of other views (930.), the vessel *c* was made to contain a solution of caustic potash in place of acid, still the same results occurred. Decomposition of the iodide was effected freely, though there was no metallic contact of dissimilar metals, and the current of electricity was in the *same direction* as when acid was used at the place of excitement.

885. Even a solution of common salt in the glass *c* could produce all these effects.

886. Having made a galvanometer with platina wires, and introduced it into the course of the current between the platina plate and the place of decomposition *x*, it was affected, giving indications of currents in the same direction as those shown to exist by the chemical action.

887. If we consider these results generally, they lead to very important conclusions. In the first place, they prove, in the

* The following is a more striking mode of making the above elementary experiment. Prepare a plate of zinc, ten or twelve inches long and two inches wide, and clean it thoroughly: provide also two discs of clean platina, about one inch and a half in diameter:—dip three or four folds of bibulous paper into a strong solution of iodide of potassium, place them on the clean zinc at one end of the plate, and put on them one of the platina discs: finally dip similar folds of paper or a piece of linen cloth into a mixture of equal parts nitric acid and water, and place it at the other end of the zinc plate with the second platina disc upon it. In this state of things no change at the solution of the iodide will be perceptible; but if the two discs be connected by a platina (or any other) wire for a second or two, and then that over the iodide be raised, it will be found that the *whole* of the surface beneath is deeply stained with *evolved iodine*.—Dec. 1838.

most decisive manner, that *metallic contact is not necessary for the production of the voltaic current.* In the next place, they show a most extraordinary mutual relation of the chemical affinities of the fluid which *excites* the current, and the fluid which is *decomposed* by it.

888. For the purpose of simplifying the consideration, let us take the experiment with amalgamated zinc. The metal so prepared exhibits no effect until the current can pass: it at the same time introduces no new action, but merely removes an influence which is extraneous to those belonging either to the production or the effect of the electric current under investigation (1000.); an influence also which, when present, tends only to confuse the results.

889. Let two plates, one of amalgamated zinc and the other of platina, be placed parallel to each other (fig. 74.), and introduce a drop of dilute sulphuric acid, *y*, between them at one end; there will be no sensible chemical action at that spot unless the two plates are connected somewhere else, as at P Z, by a body capable of conducting electricity. If that body be a metal or certain forms of carbon, then the current passes, and, as it circulates through the fluid at *y*, decomposition ensues.

890. Then remove the acid from *y*, and introduce a drop of the solution of iodide of potassium at *x* (fig. 75.). Exactly the same set of effects occur, except that when the metallic communication is made at P Z, the electric current is in the opposite direction to what it was before, as is indicated by the arrows, which show the courses of the currents (667.).

891. Now *both* the solutions used are conductors, but the conduction in them is essentially connected with decomposition (858.) in a certain constant order, and therefore the appearance of the elements in certain places *shows* in what direction a current has passed when the solutions are thus employed. Moreover, we find that when they are used at opposite ends of the plates, as in the last two experiments (889. 890.), metallic contact being allowed at the other extremities, the currents are in opposite directions. We have evidently, therefore, the power of opposing the actions of the two fluids simultaneously to each other at the opposite ends of the plates, using each one as a conductor for the discharge of the current of electricity, which,

the other tends to generate ; in fact, substituting them for metallic contact, and combining both experiments into one (fig. 76.). Under these circumstances, there is an opposition of forces : the fluid, which brings into play the stronger set of chemical affinities for the zinc, (being the dilute acid,) overcomes the force of the other, and determines the formation and direction of the electric current ; not merely making that current pass through the weaker liquid, but actually reversing the tendency which the elements of the latter have in relation to the zinc and platina if not thus counteracted, and forcing them in the contrary direction to that they are inclined to follow, that its own current may have free course. If the dominant action at y be removed by making metallic contact there, then the liquid at x resumes its power ; or if the metals be not brought into contact at y , but the affinities of the solution there weakened, whilst those active at x are strengthened, then the latter gains the ascendancy, and the decompositions are produced in a contrary order.

892. Before drawing a *final* conclusion from this mutual dependence and state of the chemical affinities of two distant portions of acting fluids (916.), I will proceed to examine more minutely the various circumstances under which the re-action of the body suffering decomposition is rendered evident upon the action of the body, also undergoing decomposition, which produces the voltaic current.

893. The use of *metallic contact* in a single pair of plates, and the cause of its great superiority above contact made by other kinds of matter, become now very evident. When an amalgamated zinc plate is dipped into dilute sulphuric acid, the force of chemical affinity exerted between the metal and the fluid is not sufficiently powerful to cause sensible action at the surfaces of contact, and occasion the decomposition of water by the oxidation of the metal, although it is sufficient to produce such a condition of the electricity (or the power upon which chemical affinity depends) as would produce a current if there were a path open for it (916. 956.) ; and that current would complete the conditions necessary, under the circumstances, for the decomposition of the water.

894. Now the presence of a piece of platina touching both the zinc and the fluid to be decomposed, opens the path re-

quired for the electricity. Its *direct communication* with the zinc is effectual, far beyond any communication made between it and that metal, (*i. e.* between the platina and zinc,) by means of decomposable conducting bodies, or, in other words, *electrolytes*, as in the experiment already described (891.); because, when *they* are used, the chemical affinities between them and the zinc produce a contrary and opposing action to that which is influential in the dilute sulphuric acid; or if that action be but small, still the affinity of their component parts for each other has to be overcome, for they cannot conduct without suffering decomposition; and this decomposition is found *experimentally* to re-act back upon the forces which in the acid tend to produce the current (904. 910. &c.), and in numerous cases entirely to neutralize them. Where direct contact of the zinc and platina occurs, these obstructing forces are not brought into action, and therefore the production and the circulation of the electric current and the concomitant action of decomposition are then highly favoured.

895. It is evident, however, that one of these opposing actions may be dismissed, and yet an electrolyte be used for the purpose of completing the circuit between the zinc and platina immersed separately into the dilute acid; for if, in fig. 73, the platina wire be retained in metallic contact with the zinc plate *a*, at *x*, and a division of the platina be made elsewhere, as at *s*, then the solution of iodide placed there, being in contact with platina at both surfaces, exerts no chemical affinities for that metal; or if it does, they are equal on both sides. Its power, therefore, of forming a current in opposition to that dependent upon the action of the acid in the vessel *c*, is removed, and only its resistance to decomposition remains as the obstacle to be overcome by the affinities exerted in the dilute sulphuric acid.

896. This becomes the condition of a single pair of active plates where *metallic contact* is allowed. In such cases, only one set of opposing affinities are to be overcome by those which are dominant in the vessel *c*; whereas, when metallic contact is not allowed, two sets of opposing affinities must be conquered (894.).

897. It has been considered a difficult, and by some an impossible thing, to decompose bodies by the current from a

single pair of plates, even when it was so powerful as to heat bars of metal red hot, as in the case of Hare's calorimeter, arranged as a single voltaic circuit, or of Wollaston's powerful single pair of metals. This difficulty has arisen altogether from the antagonism of the chemical affinity engaged in producing the current with the chemical affinity to be overcome, and depends entirely upon the relative intensity; for when the sum of forces in one has a certain degree of superiority over the sum of forces in the other, the former gain the ascendancy, determine the current, and overcome the latter so as to make the substance exerting them yield up its elements in perfect accordance, both as to direction and quantity, with the course of those which are exerting the most intense and dominant action.

898. Water has generally been the substance, the decomposition of which has been sought for as a chemical test of the passage of an electric current. But I now began to perceive a reason for its failure, and for a fact which I had observed long before (315. 316.) with regard to the iodide of potassium, namely, that bodies would differ in facility of decomposition by a given electric current, according to the condition and intensity of their ordinary chemical affinities. This reason appeared in their *re-action upon the affinities* tending to cause the current; and it appeared probable, that many substances might be found which could be decomposed by the current of a single pair of zinc and platina plates immersed in dilute sulphuric acid, although water resisted its action. I soon found this to be the case, and as the experiments offer new and beautiful proofs of the direct relation and opposition of the chemical affinities concerned in producing and in resisting the stream of electricity, I shall briefly describe them.

899. The arrangement of the apparatus was as in fig. 77. The vessel *v* contained dilute sulphuric acid; *Z* and *P* are the zinc and platina plates; *a*, *b*, and *c* are platina wires; the decompositions were effected at *x*, and occasionally, indeed generally, a galvanometer was introduced into the circuit at *g*: its place only is here given, the circle at *g* having no reference to the size of the instrument. Various arrangements were made at *x*, according to the kind of decomposition to be effected. If a drop of liquid was to be acted upon, the two ends were merely dipped into it; if a solution contained in the pores of

paper was to be decomposed, one of the extremities was connected with a platina plate supporting the paper, whilst the other extremity rested on the paper, *e*, fig. 84: or sometimes, as with sulphate of soda, a plate of platina sustained two portions of paper, one of the ends of the wires resting upon each piece, *c*, fig. 86. The darts represent the direction of the electric current (667.).

900. Solution of *iodide of potassium*, in moistened paper, being placed at the interruption of the circuit at *x*, was readily decomposed. Iodine was evolved at the *anode*, and alkali at the *cathode*, of the decomposing body.

901. *Protochloride of tin*, when fused and placed at *x*, was also readily decomposed, yielding perchloride of tin at the *anode* (779.), and tin at the *cathode*.

902. Fused chloride of silver, placed at *x*, was also easily decomposed; chlorine was evolved at the *anode*, and brilliant metallic silver, either in films upon the surface of the liquid, or in crystals beneath, evolved at the *cathode*.

903. Water acidulated with sulphuric acid, solution of muriatic acid, solution of sulphate of soda, fused nitre, and the fused chloride and iodide of lead were not decomposed by this single pair of plates, excited only by dilute sulphuric acid.

904. These experiments give abundant proofs that a single pair of plates can electrolyze bodies and separate their elements. They also show in a beautiful manner the direct relation and opposition of the chemical affinities concerned at the two points of action. In those cases where the sum of the opposing affinities at *x*, was sufficiently beneath the sum of the acting affinities in *v* decomposition took place; but in those cases where they rose higher, decomposition was effectually resisted and the current ceased to pass (891.).

905. It is however, evident, that the sum of acting affinities in *v* may be increased by using other fluids than dilute sulphuric acid, in which latter case, as I believe, it is merely the affinity of the zinc for the oxygen already combined with hydrogen in the water that is exerted in producing the electric current (919.): and when the affinities are so increased, the view I am supporting leads to the conclusion, that bodies which resisted in the preceding experiments would then be decomposed, because of the increased difference between their affinities and

the acting affinities thus exalted. This expectation was fully confirmed in the following manner.

906. A little nitric acid was added to the liquid in the vessel *v*, so as to make a mixture which I shall call diluted nitro-sulphuric acid. On repeating the experiments with this mixture, all the substances before decomposed again gave way, and much more readily. But, besides that, many which before resisted electrolyzation now yielded up their elements. Thus, solution of sulphate of soda, acted upon in the interstices of litmus and turmeric paper, yielded acid at the *anode* and alkali at the *cathode*; solution of muriatic acid tinged by indigo yielded chlorine at the *anode* and hydrogen at the *cathode*; solution of nitrate of silver yielded silver at the *cathode*. Again, fused nitre and the fused iodide and chloride of lead were decomposable by the current of this single pair of plates, though they were not by the former (903.).

907. A solution of acetate of lead was apparently not decomposed by this pair, nor did water acidulated by sulphuric acid seem at first to give way (973.).

908. The increase of intensity or power of the current produced by a simple voltaic circle, with the increase of the force of the chemical action at the exciting place, is here sufficiently evident. But in order to place it in a clearer point of view, and to show that the decomposing effect was not at all dependent, in the latter cases, upon the mere capability of evolving *more* electricity, experiments were made in which the quantity evolved could be increased without variation in the intensity of the exciting cause. Thus the experiments in which dilute sulphuric acid was used (899.) were repeated, using large plates of zinc and platina in the acid; but still those bodies which resisted decomposition before, resisted it also under these new circumstances. Then again, where nitro-sulphuric acid was used (906.), mere wires of platina and zinc were immersed in the exciting acid; yet, notwithstanding this change, those bodies were now decomposed which resisted any current tending to be formed by the dilute sulphuric acid. For instance, muriatic acid could not be decomposed by a single pair of plates when immersed in dilute sulphuric acid; nor did making the solution of sulphuric acid strong, nor enlarging the size of the zinc and platina plates immersed in it, increase the power; but

if to a weak sulphuric acid a very little nitric acid was added, then the electricity evolved had power to decompose the muriatic acid, evolving chlorine at the *anode* and hydrogen at the *cathode*, even when mere wires of metals were used. This mode of increasing the intensity of the electric current, as it excludes the effect dependent upon many pairs of plates, or even the effect of making any one acid stronger or weaker, is at once referable to the condition and force of the chemical affinities which are brought into action, and may, both in principle and practice, be considered as perfectly distinct from any other mode.

909. The direct reference which is thus experimentally made in the simple voltaic circle of the *intensity* of the electric current to the *intensity* of the chemical action going on at the place where the existence and direction of the current is determined, leads to the conclusion that by using selected bodies, as fused chlorides, salts, solutions of acids, &c., which may act upon the metals employed with different degrees of chemical force; and using also metals in association with platina, or with each other, which shall differ in the degree of chemical action exerted between them and the exciting fluid or electrolyte, we shall be able to obtain a series of comparatively constant effects due to electric currents of different intensities, which will serve to assist in the construction of a scale competent to supply the means of determining relative degrees of intensity with accuracy in future researches*.

910. I have already expressed the view which I take of the decomposition in the experimental place, as being the direct consequence of the superior exertion at some other spot of the same kind of power as that to be overcome, and therefore as the result of an antagonism of forces of the *same* nature (891. 904.). Those at the place of decomposition have a re-action upon, and a power over, the exerting or determining set proportionate to what is needful to overcome their own power; and hence a curious result of *resistance* offered by decompositions to the original determining force, and consequently to the current. This is well shown in the cases where such bodies

* In relation to this difference and its probable cause, see considerations on inductive polarization, 1354, &c.—*Dec.* 1838.

as chloride of lead, iodide of lead, and water would not decompose with the current produced by a single pair of zinc and platina plates in sulphuric acid (903.), although they would with a current of higher intensity produced by stronger chemical powers. In such cases no sensible portion of the current passes (967.); the action is stopped; and I am now of opinion that in the case of the law of conduction which I described in the Fourth Series of these Researches (413.), the bodies which are electrolytes in the fluid state cease to be such in the solid form, because the attractions of the particles by which they are retained in combination and in their relative position, are then too powerful for the electric current*. The particles retain their places; and as decomposition is prevented, the transmission of the electricity is prevented also; and although a battery of many plates may be used, yet if it be of that perfect kind which allows of no extraneous or indirect action (1000.), the whole of the affinities concerned in the activity of that battery are at the same time also suspended and counteracted.

911. But referring to the *resistance* of each single case of decomposition, it would appear that as these differ in force according to the affinities by which the elements in the substance tend to retain their places, they also would supply cases constituting a series of degrees by which to measure the initial intensities of simple voltaic or other currents of electricity, and which, combined with the scale of intensities determined by different degrees of *acting force* (909.), would probably include a sufficient set of differences to meet almost every important case where a reference to intensity would be required.

912. According to the experiments I have already had occasion to make, I find that the following bodies are electrolytic in the order in which I have placed them, those which are first being decomposed by the current of lowest intensity. These currents were always from a single pair of plates, and may be considered as elementary *voltaic forces*.

Iodide of potassium (solution).

Chloride of silver (fused).

Protochloride of tin (fused).

Chloride of lead (fused).

Iodide of lead (fused).

* Refer onwards to 1705.—*Dec.* 1838.

Muriatic acid (solution).

Water, acidulated with sulphuric acid.

913. It is essential that, in all endeavours to obtain the relative electrolytic intensity necessary for the decomposition of different bodies, attention should be paid to the nature of the electrodes and the other bodies present which may favour secondary actions (986.). If in electro-decomposition one of the elements separated has an affinity for the electrode, or for bodies present in the surrounding fluid, then the affinity resisting decomposition is in part balanced by such power, and the true place of the electrolyte in a table of the above kind is not obtained: thus, chlorine combines with a positive platina electrode freely, but iodine scarcely at all, and therefore I believe it is that the fused chlorides stand first in the preceding Table. Again, if in the decomposition of water not merely sulphuric but also a little nitric acid be present, then the water is more freely decomposed, for the hydrogen at the *cathode* is not ultimately expelled, but finds oxygen in the nitric acid, with which it can combine to produce a secondary result; the affinities opposing decomposition are in this way diminished, and the elements of the water can then be separated by a current of lower intensity.

914. Advantage may be taken of this principle to interpolate more minute degrees into the scale of initial intensities already referred to (909. 911.) than is there spoken of; for by combining the force of a current *constant* in its intensity, with the use of electrodes consisting of matter, having more or less affinity for the elements evolved from the decomposing electrolyte, various intermediate degrees may be obtained.

915. Returning to the consideration of the source of electricity (878. &c.), there is another proof of the most perfect kind that metallic contact has nothing to do with the *production* of electricity in the voltaic circuit, and further, that electricity is only another mode of the exertion of chemical forces. It is, the production of the *electric spark* before any contact of metals is made, and by the exertion of *pure and unmixed chemical forces*. The experiment, which will be described further on (956.), consists in obtaining the spark upon making contact between a plate of zinc and a plate of copper plunged into di-

lute sulphuric acid. In order to make the arrangement as elementary as possible, mercurial surfaces were dismissed, and the contact made by a copper wire connected with the copper plate, and then brought to touch a clean part of the zinc plate. The electric spark appeared, and it must of necessity have existed and passed *before the zinc and the copper were in contact.*

916. In order to render more distinct the principles which I have been endeavouring to establish, I will restate them in their simplest form, according to my present belief. The electricity of the voltaic pile (856. note) is not dependent either in its origin or its continuance upon the contact of the metals with each other (880. 915.). It is entirely due to chemical action (882.), and is proportionate in its intensity to the intensity of the affinities concerned in its production (908.) ; and in its quantity to the quantity of matter which has been chemically active during its evolution (869.). This definite production is again one of the strongest proofs that the electricity is of chemical origin.

917. As *volta-electro-generation* is a case of mere chemical action, so *volta-electro-decomposition* is simply a case of the preponderance of one set of chemical affinities more powerful in their nature, over another set which are less powerful : and if the instance of two opposing sets of such forces (891.) be considered, and their mutual relation and dependence borne in mind, there appears no necessity for using, in respect to such cases, any other term than chemical affinity, (though that of electricity may be very convenient,) or supposing any new agent to be concerned in producing the results ; for we may consider that the powers at the two places of action are in direct communion and balanced against each other through the medium of the metals (891.), fig. 76, in a manner analogous to that in which mechanical forces are balanced against each other by the intervention of the lever (1031.).

918. All the facts show us that that power commonly called chemical affinity, can be communicated to a distance through the metals and certain forms of carbon ; that the electric current is only another form of the forces of chemical affinity ; that its power is in proportion to the chemical affinities producing it ; that when it is deficient in force it may be helped by calling in

chemical aid, the want in the former being made up by an equivalent of the latter; that, in other words, *the forces termed chemical affinity and electricity are one and the same.*

919. When the circumstances connected with the production of electricity in the ordinary voltaic circuit are examined and compared, it appears that the source of that agent, always meaning the electricity which circulates and completes the current in the voltaic apparatus, and gives that apparatus power and character (947. 996.), exists in the chemical action which takes place directly between the metal and the body with which it combines, and not at all in the subsequent action of the substance so produced with the acid present*. Thus, when zinc, platina, and dilute sulphuric acid are used, it is the union of the zinc with the oxygen of the water which determines the current; and though the acid is essential to the removal of the oxide so formed, in order that another portion of zinc may act on another portion of water, it does not, by combination with that oxide, produce any sensible portion of the current of electricity which circulates; for the quantity of electricity is dependent upon the quantity of zinc oxidized, and in definite proportion to it: its intensity is in proportion to the intensity of the chemical affinity of the zinc for the oxygen under the circumstances, and is scarcely, if at all, affected by the use of either strong or weak acid (908.).

920. Again, if zinc, platina, and muriatic acid are used, the electricity appears to be dependent upon the affinity of the zinc for the chlorine, and to be circulated in exact proportion to the number of particles of zinc and chlorine which unite, being in fact an equivalent to them.

921. But in considering this oxidation, or other direct action upon the METAL itself, as the cause and source of the electric current, it is of the utmost importance to observe that the oxygen or other body must be in a peculiar condition, namely, in the state of *combination*; and not only so, but limited still further to such a state of combination and in such proportions as will constitute an *electrolyte* (823.). A pair of zinc and platina plates cannot be so arranged in oxygen gas as to produce a

* Wollaston, Philosophical Transactions, 1801, p. 427.

current of electricity, or act as a voltaic circle, even though the temperature may be raised so high as to cause oxidation of the zinc far more rapidly than if the pair of plates were plunged into dilute sulphuric acid; for the oxygen is not part of an electrolyte, and cannot therefore conduct the forces onwards by decomposition, or even as metals do by itself. Or if its gaseous state embarrass the minds of some, then liquid chlorine may be taken. It does not excite a current of electricity through the two plates by combining with the zinc, for its particles cannot transfer the electricity active at the point of combination across to the platinum. It is not a conductor of itself, like the metals; nor is it an electrolyte, so as to be capable of conduction during decomposition, and hence there is simple chemical action at the spot, and no electric current*.

922. It might at first be supposed that a conducting body, not electrolytic, might answer as the third substance between the zinc and the platinum; and it is true that we have some such capable of exerting chemical action upon the metals. They must, however, be chosen from the metals themselves, for there are no bodies of this kind except those substances and charcoal. To decide the matter by experiment, I made the following arrangement. Melted tin was put into a glass tube bent into the form of the letter V, fig. 78, so as to fill the half of each limb, and two pieces of thick platinum wire, *p*, *w*, inserted, so as to have their ends immersed some depth in the tin: the whole was then allowed to cool, and the ends *p* and *w* connected with a delicate galvanometer. The part of the tube at *x* was now reheated, whilst the portion *y* was retained cool. The galvanometer was immediately influenced by the thermo-electric current produced. The heat was steadily increased at *x*, until at last the tin and platinum combined there; an effect which is known to take place with strong chemical action and high ignition; but not the slightest additional effect occurred at the galvanometer. No other deflection than that due to the ther-

* I do not mean to affirm that no traces of electricity ever appear in such cases. What I mean is, that no electricity is evolved in any way, due or related to the causes which excite voltaic electricity, or proportionate to them. That which does appear occasionally is the smallest possible fraction of that which the acting matter could produce if arranged so as to act voltaically, probably not the one hundred thousandth, or even the millionth part, and is very probably altogether different in its source.

no-electric current was observable the whole time. Hence, though a conductor, and one capable of exerting chemical action on the tin, was used, yet, not being an *electrolyte*, not the slightest effect of an electrical current could be observed (947.).

923. From this it seems apparent that the peculiar character and condition of an electrolyte is *essential* in one part of the voltaic circuit; and its nature being considered, good reasons appear why it and it alone should be effectual. An electrolyte is always a compound body: it can conduct, but only whilst decomposing. Its conduction depends upon its decomposition and the *transmission of its particles* in directions parallel to the current; and so intimate is this connexion, that if their transition be stopped, the current is stopped also; if their course be changed, its course and direction changes with them; if they proceed in one direction, it has no power to proceed in any other than a direction invariably dependent on them. The particles of an electrolytic body are all so mutually connected, are in such relation with each other through their whole extent in the direction of the current, that if the last is not disposed of, the first is not at liberty to take up its place in the new combination which the powerful affinity of the most active metal tends to produce; and then the current itself is stopped; for the dependencies of the current and the decomposition are so mutual, that whichever be originally determined, *i. e.* the motion of the particles or the motion of the current, the other is invariable in its concomitant production and its relation to it.

924. Consider, then, water as an electrolyte and also as an oxidizing body. The attraction of the zinc for the oxygen is greater, under the circumstances, than that of the oxygen for the hydrogen; but in combining with it, it tends to throw into circulation a current of electricity in a certain direction. This direction is consistent (as is found by innumerable experiments) with the transfer of the hydrogen from the zinc towards the platina, and the transfer in the opposite direction of fresh oxygen from the platina towards the zinc; so that the current *can pass* in that one line, and, whilst it passes, can consist with and favour the renewal of the conditions upon the surface of the zinc, which at first determined both the combination and circulation. Hence the continuance of the action there, and

the continuation of the current. It therefore appears quite as essential that there should be an electrolyte in the circuit, in order that the action may be transferred forward, in a *certain constant direction*, as that there should be an oxidizing or other body capable of acting directly on the metal; and it also appears to be essential that these two should merge into one, or that the principle directly active on the metal by chemical action should be one of the *ions* of the electrolyte used. Whether the voltaic arrangement be excited by solution of acids, or alkalies, or sulphurets, or by fused substances (476.), this principle has always hitherto, as far as I am aware, been an *anion* (943.); and I anticipate, from a consideration of the principles of electric action, that it must of necessity be one of that class of bodies.

925. If the action of the sulphuric acid used in the voltaic circuit be considered, it will be found incompetent to produce any sensible portion of the electricity of the current by its combination with the oxide formed, for this simple reason, it is deficient in a most essential condition: it forms no part of an electrolyte, nor is it in relation with any other body present in the solution which will permit of the mutual transfer of the particles and the consequent transfer of the electricity. It is true, that as the plane at which the acid is dissolving the oxide of zinc formed by the action of the water, is in contact with the metal zinc, there seems no difficulty in considering how the oxide there could communicate an electrical state, proportionate to its own chemical action on the acid, to the metal, which is a conductor without decomposition. But on the side of the acid there is no substance to complete the circuit: the water, as water, cannot conduct it, or at least only so small a proportion that it is merely an incidental and almost inappreciable effect (970.); and it cannot conduct it as an electrolyte, because an electrolyte conducts in consequence of the *mutual* relation and action of its particles; and neither of the elements of the water, nor even the water itself, as far as we can perceive, are *ions* with respect to the sulphuric acid (848.)*.

926. This view of the secondary character of the sulphuric

* It will be seen that I here agree with Sir Humphry Davy, who has experimentally supported the opinion that acids and alkalies in combining do not produce any current of electricity. *Philosophical Transactions*, 1826, p. 398.

acid as an agent in the production of the voltaic current, is further confirmed by the fact, that the current generated and transmitted is directly and exactly proportional to the quantity of water decomposed and the quantity of zinc oxidized (868. 991.), and is the same as that required to decompose the same quantity of water. As, therefore, the decomposition of the water shows that the electricity has passed by its means, there remains no other electricity to be accounted for or to be referred to any action other than that of the zinc and the water on each other.

927. The general case (for it includes the former one (924),) of acids and bases, may theoretically be stated in the following manner. Let *a*, fig. 79, be supposed to be a dry oxide, and *b* a dry base, in contact at *c*, and in electric communication at their extremities by plates of platina *p p*, and a platina wire *w*. If this acid and base were fluid, and combination took place at *c*, with an affinity ever so vigorous, and capable of originating an electric current, the current could not circulate in any important degree; because, according to the experimental results, neither *a* nor *b* could conduct without being decomposed, for they are either electrolytes or else insulators, under all circumstances, except to very feeble and unimportant currents (970. 986.). Now the affinities at *c* are not such as tend to cause the *elements* either of *a* or *b* to separate, but only such as would make the two bodies combine together as a whole; the point of action is, therefore, insulated, the action itself local (921. 947.), and no current can be formed.

928. If the acid and base be dissolved in water, then it is possible that a small portion of the electricity due to chemical action may be conducted by the water without decomposition (966. 984.); but the quantity will be so small as to be utterly disproportionate to that due to the equivalents of chemical force; will be merely incidental; and, as it does not involve the essential principles of the voltaic pile, it forms no part of the phenomena at present under investigation*.

* It will I trust be fully understood, that in these investigations I am not professing to take an account of every small, incidental, or barely possible effect, dependent upon slight disturbances of the electric fluid during chemical action, but am seeking to distinguish and identify those actions on which the power of the voltaic battery essentially depends.

929. If for the oxacid a hydracid be substituted (927.),—as one analagous to the muriatic, for instance,—then the state of things changes altogether, and a current due to the chemical action of the acid on the base is possible. But now both the bodies act as electrolytes, for it is only one principle of each which combine mutually,—as, for instance, the chlorine with the metal,—and the hydrogen of the acid and the oxygen of the base are ready to traverse with the chlorine of the acid and the metal of the base in conformity with the current and according to the general principles already so fully laid down.

930. This view of the oxidation of the metal, or other *direct* chemical action upon it, being the sole cause of the production of the electric current in the ordinary voltaic pile, is supported by the effects which take place when alkaline or sulphuretted solutions (931. 943.) are used for the electrolytic conductor instead of dilute sulphuric acid. It was in elucidation of this point that the experiments without metallic contact, and with solution of alkali as the exciting fluid, already referred to (884.), were made.

931. Advantage was then taken of the more favourable condition offered, when metallic contact is allowed (895.), and the experiments upon the decomposition of bodies by a single pair of plates (899.) were repeated, solution of caustic potassa being employed in the vessel *v*, fig. 77. in place of dilute sulphuric acid. All the effects occurred as before: the galvanometer was deflected; the decompositions of the solutions of iodide of potassium, nitrate of silver, muriatic acid, and sulphate of soda ensued at *x*; and the places where the evolved principles appeared, as well as the deflection of the galvanometer, indicated a current in the *same direction* as when acid was in the vessel *v*; *i. e.* from the zinc through the solution to the platina, and back by the galvanometer and substance suffering decomposition to the zinc.

932. The similarity in the action of either dilute sulphuric acid or potassa goes indeed far beyond this, even to the proof of identity in *quantity* as well as in *direction* of the electricity produced. If a plate of amalgamated zinc be put into a solution of potassa, it is not sensibly acted upon; but if touched in the solution by a plate of platina, hydrogen is evolved on the

surface of the latter metal, and the zinc is oxidized exactly as when immersed in dilute sulphuric acid (863.). I accordingly repeated the experiment before described with weighed plates of zinc (864. &c.), using however solution of potassa instead of dilute sulphuric acid. Although the time required was much longer than when acid was used, amounting to three hours for the oxidization of 7.55 grains of zinc, still I found that the hydrogen evolved at the platina plate was the equivalent of the metal oxidized at the surface of the zinc. Hence the whole of the reasoning which was applicable in the former instance applies also here, the current being in the same direction, and its decomposing effect in the same degree, as if acid instead of alkali had been used (868.).

933. The proof, therefore, appears to me complete, that the combination of the acid with the oxide, in the former experiment, had nothing to do with the production of the electric current; for the same current is here produced when the action of the acid is absent, and the reverse action of an alkali is present. I think it cannot be supposed for a moment, that the alkali acted chemically as an acid to the oxide formed; on the contrary, our general chemical knowledge leads to the conclusion, that the ordinary metallic oxides act rather as acids to the alkalies; yet that kind of action would tend to give a reverse current in the present case, if any were due to the union of the oxide of the exciting metal with the body which combines with it. But instead of any variation of this sort, the direction of the electricity was constant, and its quantity also directly proportional to the water decomposed, or the zinc oxidized. There are reasons for believing that acids and alkalies, when in contact with metals upon which they cannot act directly, still have a power of influencing their attractions for oxygen (941.); but all the effects in these experiments prove, I think, that it is the oxidation of the metal necessarily dependent upon, and associated as it is with, the electrolyzation of the water (921. 923.) that produces the current; and that the acid or alkali merely act as solvents, and by removing the oxidized zinc, allow other portions to decompose fresh water, and so continue the evolution or determination of the current.

934. The experiments were then varied by using solution of ammonia instead of solution of potassa; and as it, when pure,

is like water, a bad conductor (554.), it was occasionally improved in that power by adding sulphate of ammonia to it. But in all the cases the results were the same as before; decompositions of the same kind were effected, and the electric current producing these was in the same direction as in the experiments just described.

935. In order to put the equal and similar action of acid and alkali to stronger proof, arrangements were made as in fig. 80.: the glass vessel A contained dilute sulphuric acid, the corresponding glass vessel B solution of potassa, P P was a plate of platina dipping into both solutions, and Z Z two plates of amalgamated zinc connected with a delicate galvanometer. When these were plunged at the same time into the two vessels, there was generally a first feeble effect, and that in favour of the alkali, *i. e.* the electric current tended to pass through the vessels in the direction of the arrow, being the reverse direction of that which the acid in A would have produced alone; but the effect instantly ceased, and the action of the plates in the vessels was so equal, that, being contrary because of the contrary position of the plates, no permanent current resulted.

936. Occasionally a zinc plate was substituted for the plate P P, and platina plates for the plates Z Z; but this caused no difference in the results: nor did a further change of the middle plate to copper produce any alteration.

937. As the opposition of electric-motive pairs of plates produces results other than those due to the mere difference of their independent actions (1011. 1045.), I devised another form of apparatus, in which the action of acid and alkali might be more directly compared. A cylindrical glass cup, about two inches deep within, an inch in internal diameter, and at least a quarter of an inch in thickness, was cut down the middle into halves, fig. 81. A broad brass ring, larger in diameter than the cup, was supplied with a screw at one side; so that when the two halves of the cup were within the ring, and the screw was made to press tightly against the glass, the cup held any fluid put into it. Bibulous paper of different degrees of permeability was then cut into pieces of such a size as to be easily introduced between the loosened halves of the cup, and served when the latter were tightened again to form a porous division down the middle of the cup, sufficient to keep any two fluids

on opposite sides of the paper from mingling, except very slowly, and yet allowing them to act freely as one *electrolyte*. The two spaces thus produced I will call the cells A and B, fig. 82. This instrument I have found of most general application in the investigation of the relation of fluids and metals amongst themselves and to each other. By combining its use with that of the galvanometer, it is easy to ascertain the relation of one metal with two fluids, or of two metals with one fluid, or of two metals and two fluids upon each other.

938. Dilute sulphuric acid, sp. gr. 1.25. was put into the cell A, and a strong solution of caustic potassa into the cell B; they mingled slowly through the paper, and at last a thick crust of sulphate of potassa formed on the side of the paper next to the alkali. A plate of clean platina was put into each cell and connected with a delicate galvanometer, but no electric current could be observed. Hence the *contact* of acid with one platina plate, and alkali with the other, was unable to produce a current; nor was the combination of the acid with the alkali more effectual (925.).

939. When one of the platina plates was removed and a zinc plate substituted, either amalgamated or not, a strong electric current was produced. But, whether the zinc were in the acid whilst the platina was in the alkali, or whether the reverse order were chosen, the electric current was always from the zinc through the electrolyte to the platina, and back through the galvanometer to the zinc, the current seeming to be strongest when the zinc was in the alkali and the platina in the acid.

940. In these experiments, therefore, the acid seems to have no power over the alkali, but to be rather inferior to it in force. Hence there is no reason to suppose that the combination of the oxide formed with the acid around it has any direct influence in producing the electricity evolved, the whole of which appears to be due to the oxidation of the metal (919.).

941. The alkali, in fact, is superior to the acid in bringing a metal into what is called the positive state; for if plates of the same metal, as zinc, tin, lead, or copper, be used both in the acid or alkali, the electric current is from the alkali across the cell to the acid, and back through the galvanometer to the alkali, as Sir Humphry Davy formerly stated*. This current is

* Elements of Chemical Philosophy, p. 149; or Philosophical Transactions, 1826, p. 403.

so powerful, that if amalgamated zinc, or tin, or lead be used, the metal in the acid evolves hydrogen the moment it is placed in communication with that in the alkali, not from any direct action of the acid upon it, for if the contact be broken, the action ceases, but because it is powerfully negative with regard to the metal in the alkali.

942. The superiority of alkali is further proved by this, that if zinc and tin be used, or tin and lead, whichever metal is put into the alkali becomes positive, that in the acid being negative. Whichever is in the alkali is oxidized, whilst that in the acid remains in the metallic state, as far as the electric current is concerned.

943. When sulphuretted solutions are used (930.) in illustration of the assertion, that it is the chemical action of the metal and one of the *ions* of the associated electrolyte that produces all the electricity of the voltaic circuit, the proofs are still the same. Thus, as Sir Humphry Davy* has shown, if iron and copper be plunged into dilute acid, the current is from the iron through the liquid to the copper; in solution of potassa it is in the same direction, but in solution of sulphuret of potassa it is reversed. In the two first cases it is oxygen which combines with the iron, in the latter sulphur which combines with the copper, that produces the electric current; but both of these are *ions*, existing as such in the electrolyte, which is at the same moment suffering decomposition; and, what is more, both of these are *anions*, for they leave the electrolytes at their *anodes*, and act just as chlorine, iodine, or any other *anion* would act which might have been previously chosen as that which should be used to throw the voltaic circle into activity.

944. The following experiments complete the series of proofs of the origin of the electricity in the voltaic pile. A fluid amalgam of potassium, containing not more than a hundredth of that metal, was put into pure water, and connected through the galvanometer with a plate of platina in the same water. There was immediately an electric current from the amalgam through the electrolyte to the platina. This must have been due to the oxidation only of the metal, for there was neither

* Elements of Chemical Philosophy, p. 148.

acid nor alkali to combine with, or in any way act on, the body produced.

945. Again, a plate of clean lead and a plate of platina were put into *pure* water. There was immediately a powerful current produced from the lead through the fluid to the platina: it was even intense enough to decompose solution of the iodide of potassium when introduced into the circuit in the form of apparatus already described (880.), fig. 73. Here no action of acid or alkali on the oxide formed from the lead could supply the electricity: it was due solely to the oxidation of the metal.

946. There is no point in electrical science which seems to me of more importance than the state of the metals and the electrolytic conductor in a simple voltaic circuit *before and at* the moment when metallic contact is first completed. If clearly understood, I feel no doubt it would supply us with a direct key to the laws under which the great variety of voltaic excitations, direct and incidental, occur, and open out new fields of research for our investigation*.

947. We seem to have the power of deciding to a certain extent in numerous cases of chemical affinity, (as of zinc with the oxygen of water, &c. &c.) which of *two modes of action of the attractive power* shall be exerted (996.). In the one mode we can transfer the power onwards, and make it produce elsewhere its equivalent of action (867. 917.); in the other it is not transferred, but exerted wholly at the spot. The first is the case of volta-electric excitation, the other ordinary chemical affinity: but both are chemical actions and due to one force or principle.

948. The general circumstances of the former mode occur in all instances of voltaic currents, but may be considered as in their perfect condition, and then free from those of the second mode, in some only of the cases; as in those of plates of zinc and platina in solution of potassa, or of amalgamated zinc and platina in dilute sulphuric acid.

949. Assuming it sufficiently proved, by the preceding experiments and considerations, that the electro-motive action de-

* In connexion with this part of the subject refer now to Series XI. 1164, Series XII. 1343—1358, and Series XIII. 1621 &c.—*Dec.* 1838.

pend, when zinc, platina, and dilute sulphuric acid are used, upon the mutual affinity of the metal zinc and the oxygen of the water (921. 924.), it would appear that the metal, when alone, has not power enough, under the circumstances, to take the oxygen and expel the hydrogen from the water; for, in fact, no such action takes place. But it would also appear that it has power so far to act, by its attraction for the oxygen of the particles in contact with it, as to place the similar forces already active between these and the other particles of oxygen and the particles of hydrogen in the water, in a peculiar state of tension or polarity, and probably also at the same time to throw those of its own particles which are in contact with the water into a similar but opposed state. Whilst this state is retained, no further change occurs; but when it is relieved, by completion of the circuit, in which case the forces determined in opposite directions, with respect to the zinc and the electrolyte, are found exactly competent to neutralize each other, then a series of decompositions and recompositions takes place amongst the particles of oxygen and hydrogen constituting the water, between the place of contact with the platina and the place where the zinc is active; these intervening particles being evidently in close dependence upon and relation to each other. The zinc forms a direct compound with those particles of oxygen which were, previously, in divided relation to both it and the hydrogen: the oxide is removed by the acid, and a fresh surface of zinc is presented to the water, to renew and repeat the action.

950. Practically, the state of tension is best relieved by dipping a metal which has less attraction for oxygen than the zinc, into the dilute acid, and making it also touch the zinc. The force of chemical affinity, which has been influenced or polarized in the particles of the water by the dominant attraction of the zinc for the oxygen, is then transferred, in a most extraordinary manner, through the two metals, so as to re-enter upon the circuit in the electrolytic conductor, which, unlike the metals in that respect, cannot convey or transfer it without suffering decomposition; or rather, probably, it is exactly balanced and neutralized by the force which at the same moment completes the combination of the zinc with the oxygen of the water. The forces, in fact, of the two particles which are acting towards

each other, and which are therefore in opposite directions, are the origin of the two opposite forces, or directions of force, in the current. They are of necessity equivalent to each other. Being transferred forward in contrary directions, they produce what is called the voltaic current: and it seems to me impossible to resist the idea that it must be preceded by a *state of tension* in the fluid, and between the fluid and the zinc; the *first consequence* of the affinity of the zinc for the oxygen of the water.

951. I have sought carefully for indications of a state of tension in the electrolytic conductor; and conceiving that it might produce something like structure, either before or during its discharge, I endeavoured to make this evident by polarized light. A glass cell, seven inches long, one inch and a half wide, and six inches deep, had two sets of platina electrodes adapted to it, one set for the ends, and the other for the sides. Those for the *sides* were seven inches long by three inches high, and when in the cell were separated by a little frame of wood covered with calico; so that when made active by connexion with a battery upon any solution in the cell, the bubbles of gas rising from them did not obscure the central parts of the liquid.

952. A saturated solution of sulphate of soda was put into the cell, and the electrodes connected with a battery of 150 pairs of 4-inch plates: the current of electricity was conducted across the cell so freely, that the discharge was as good as if a wire had been used. A ray of polarised light was then transmitted through the solution, directly across the course of the electric current, and examined by an analyzing plate; but though it penetrated seven inches of solution thus subject to the action of the electricity, and though contact was sometimes made, sometimes broken, and occasionally reversed during the observations, not the slightest trace of action on the ray could be perceived.

953. The large electrodes were then removed, and others introduced which fitted the *ends* of the cell. In each a slit was cut, so as to allow the light to pass. The course of the polarized ray was now parallel to the current, or in the direction of its axis (517.); but still no effect, under any circumstances of contact or disunion, could be perceived upon it.

954. A strong solution of nitrate of lead was employed instead of the sulphate of soda, but no effects could be detected.

955. Thinking it possible that the discharge of the electric forces by the successive decompositions and recompositions of the particles of the electrolyte might neutralize and therefore destroy any effect which the first state of tension could by possibility produce, I took a substance which, being an excellent electrolyte when fluid, was a perfect insulator when solid, namely, borate of lead, in the form of a glass plate, and connecting the sides and the edges of this mass with the metallic plates, sometimes in contact with the poles of a voltaic battery, and sometimes even with the electric machine, for the advantage of the much higher intensity then obtained, I passed a polarized ray across it in various directions, as before, but could not obtain the slightest appearance of action upon the light. Hence I conclude, that notwithstanding the new and extraordinary state which must be assumed by an electrolyte, either during decomposition (when a most enormous quantity of electricity must be traversing it), or in the state of tension which is assumed as preceding decomposition, and which might be supposed to be retained in the solid form of the electrolyte, still it has no power of affecting a polarized ray of light; for no kind of structure or tension can in this way be rendered evident.

956. There is, however, one beautiful experimental proof of a state of tension acquired by the metals and the electrolyte before the electric current is produced, and *before contact* of the different metals is made (915.); in fact, at that moment when chemical forces only are efficient as a cause of action. I took a voltaic apparatus, consisting of a single pair of large plates, namely, a cylinder of amalgamated zinc, and a double cylinder of copper. These were put into a jar containing dilute sulphuric acid*, and could at pleasure be placed in metallic communication by a copper wire adjusted so as to dip at the extremities into two cups of mercury connected with the two plates.

957. Being thus arranged, there was no chemical action whilst the plates were not connected. On *making* the con-

* When nitro-sulphuric acid is used, the spark is more powerful, but local chemical action can then commence, and proceed without requiring metallic contact.

nexion, a spark was obtained*, and the solution was immediately decomposed. On breaking it, the usual spark was obtained, and the decomposition ceased. In this case it is evident that the first spark must have occurred before metallic contact was made, for it passed through an interval of air; and also that it must have tended to pass before the electrolytic action began; for the latter could not take place until the current passed, and the current could not pass before the spark appeared. Hence I think there is sufficient proof, that as it is the zinc and water which by their mutual action produce the electricity of this apparatus, so these by their first contact with each other, were placed in a state of powerful tension (951.), which, though it could not produce the actual decomposition of the water, was able to make a spark of electricity pass between the zinc and a fit discharger as soon as the interval was rendered sufficiently small. The experiment demonstrates the direct production of the electric spark from pure chemical forces.

958. There are a few circumstances connected with the production of this spark by a single pair of plates, which should be known, to ensure success to the experiment†. When the amalgamated surfaces of contact are quite clean and dry, the spark, on making contact, is quite as brilliant as on breaking it, if not even more so. When a film of oxide or dirt was present at either mercurial surface, then the first spark was often feeble, and often failed, the breaking spark, however, continuing very constant and bright. When a little water was put over the mercury, the spark was greatly diminished in brilliancy, but very regular both on making and breaking contact. When the contact was made between clean platina, the spark was also very small, but regular both ways. The true electric spark is, in fact, very small, and when surfaces of mercury are used, it is the combustion of the metal which produces the greater part of the light. The circumstances connected with the burning of the mercury are most favourable on breaking contact; for

* It has been universally supposed that no spark is produced on making the contact between a single pair of plates. I was led to expect one from the considerations already advanced in this paper. The wire of communication should be short; for with a long wire, circumstances strongly affecting the spark are introduced.

† See in relation to precautions respecting a spark, 1074.—*Dec.* 1838.

the act of separation exposes clean surfaces of metal, whereas, on making contact a thin film of oxide, or soiling matter, often interferes. Hence the origin of the general opinion that it is only when the contact is broken that the spark passes.

959. With reference to the other set of cases, namely, those of local action (947.) in which chemical affinity being exerted causes no transference of the power to a distance where no electric current is produced, it is evident that forces of the most intense kind must be active, and in some way balanced in their activity, during such combinations; these forces being directed so immediately and exclusively towards each other, that no signs of the powerful electric current they can produce become apparent, although the same final state of things is obtained as if that current had passed. It was Berzelius, I believe, who considered the heat and light evolved in cases of combustion as the consequences of this mode of exertion of the electric powers of the combining particles. But it will require a much more exact and extensive knowledge of the nature of electricity, and the manner in which it is associated with the atoms of matter, before we can understand accurately the action of this power in thus causing their union, or comprehend the nature of the great difference which it presents in the two modes of action just distinguished. We may imagine, but such imaginations must for the time be classed with the great mass of *doubtful knowledge* (876.) which we ought rather to strive to diminish than to increase; for the very extensive contradictions of this knowledge by itself shows that but a small portion of it can ultimately prove true*.

960. Of the two modes of action in which chemical affinity is exerted, it is important to remark, that that which produces the electric current is as *definite* as that which causes ordinary chemical combination; so that in examining the *production* or *evolution* of electricity in cases of combination or decomposition, it will be necessary, not merely to observe certain defects dependent upon a current of electricity, but also their *quantity*; and though it may often happen that the forces concerned in any particular case of chemical action may be partly exerted in

* Refer to 1738, etc. Series XIV.—Dec. 1838.

one mode and partly in the other, it is only those which are efficient in producing the current that have any relation to voltaic action. Thus, in the combination of oxygen and hydrogen to produce water, electric powers to a most enormous amount are for the time active (861. 873.) ; but any mode of examining the flame which they form during energetic combination, which has as yet been devised, has given but the feeblest traces. These therefore may not, cannot, be taken as evidences of the nature of the action ; but are merely incidental results, incomparably small in relation to the forces concerned, and supplying no information of the way in which the particles are active on each other, or in which their forces are finally arranged.

961. That such cases of chemical action produce no *current of electricity*, is perfectly consistent with what we know of the voltaic apparatus, in which it is essential that one of the combining elements shall form part of, or be in direct relation with, an electrolytic conductor (921. 923.). That such cases produce no *free electricity of tension*, and that when they are converted into cases of voltaic action they produce a current in which the opposite forces are so equal as to neutralize each other, prove the equality of the forces in the opposed acting particles of matter, and therefore the equality of electric power in those quantities of matter which are called *electro-chemical equivalents* (824.). Hence another proof of the definite nature of electro-chemical action (783. &c.), and that chemical affinity and electricity are forms of the same power (917. &c.).

962. The direct reference of the effects produced by the voltaic pile at the place of experimental decomposition to the chemical affinities active at the place of excitation (891. 917.), gives a very simple and natural view of the cause why the bodies (or *ions*) evolved pass in certain directions ; for it is only when they pass in those directions that their forces can consist with and compensate (in direction at least) the superior forces which are dominant at the place where the action of the whole is determined. If, for instance, in a voltaic circuit, the activity of which is determined by the attraction of zinc for the oxygen of water, the zinc move from right to left, then any other *cation* included in the circuit, being part of an electrolyte, or forming part of it at the moment, will also move from right to left : and as the oxygen of the water, by its natural affinity for the zinc,

moves from left to right, so any other body of the same class with it (*i. e.* any other *anion*), under its government for the time, will move from left to right.

963. This I may illustrate by reference to fig. 83, the double circle of which may represent a complete voltaic circuit, the direction of its forces being determined by supposing for a moment the zinc *b* and the platina *c* as representing plates of those metals acting upon water, *d*, *e*, and other substances, but having their energy exalted so as to effect several decompositions by the use of a battery at *a* (989.). This supposition may be allowed, because the action in the battery will only consist of repetitions of what would take place between *b* and *c*, if they really constituted but a single pair. The zinc *b*, and the oxygen *d*, by their mutual affinity, tend to unite; but as the oxygen is already in association with the hydrogen *e*, and has its inherent chemical or electric powers neutralized for the time by those of the latter, the hydrogen *e* must leave the oxygen *d*, and advance in the direction of the arrow head, or else the zinc *b* cannot move in the same direction to unite to the oxygen *d*, nor the oxygen *d* move in the contrary direction to unite to the zinc *b*, the relation of the *similar* forces of *b* and *e*, in contrary directions, to the *opposite* forces of *d* being the preventive. As the hydrogen *e* advances, it, on coming against the platina *c*, *f*, which forms a part of the circuit, communicates its electric or chemical forces through it to the next electrolyte in the circuit, fused chloride of lead, *g*, *h*, where the chlorine must move in conformity with the direction of the oxygen at *d*, for it has to compensate the forces disturbed in its part of the circuit by the superior influence of those between the oxygen and zinc at *d*, *b*, aided as they are by those of the battery *a*; and for a similar reason the lead must move in the direction pointed out by the arrow head, that it may be in right relation to the first moving body of its own class, namely, the zinc *b*. If copper intervene in the circuit from *i* to *k*, it acts as the platina did before; and if another electrolyte, as the iodide of tin, occur at *l*, *m*, then the iodine *l*, being an *anion*, must move in conformity with the exciting *anion*, namely, the oxygen *d*, and the *cation* tin *m* move in correspondence with the other *cations*, *b*, *e*, and *h*, that the chemical forces may be in equilibrium as to their direction and quantity throughout the circuit. Should it

so happen that the anions in their circulation can combine with the metals at the *anodes* of the respective electrolytes, as would be the case at the platina *f* and the copper *k*, then those bodies becoming parts of electrolytes, under the influence of the current, immediately travel; but considering their relation to the zinc *b*, it is evidently impossible that they can travel in any other direction than what will accord with its course, and therefore can never tend to pass otherwise than *from* the anode and *to* the cathode.

964. In such a circle as that delineated, therefore, all the known *anions* may be grouped within, and all the *cations* without. If any number of them enter as *ions* into the constitution of *electrolytes*, and, forming one circuit, are simultaneously subject to one common current, the anions must move in accordance with each other in one direction, and the cations in the other. Nay, more than that, equivalent portions of these bodies must so advance in opposite directions: for the advance of every 32.5 parts of the zinc *b* must be accompanied by a motion in the opposite direction of 8 parts of oxygen at *d*, of 36 parts of chlorine at *g*, of 126 parts of iodine at *l*; and in the same direction by electro-chemical equivalents of hydrogen, lead, copper and tin, at *e*, *h*, *k*, and *m*.

965. If the present paper be accepted as a correct expression of facts, it will still only prove a confirmation of certain general views put forth by Sir Humphry Davy in his Bakerian Lecture for 1806*, and revised and re-stated by him in another Bakerian Lecture, on electrical and chemical changes, for the year 1826†. His general statement is, that “*chemical and electrical attractions were produced by the same cause, acting in one case on particles, in the other on masses, of matter; and that the same property, under different modifications, was the cause of all the phenomena exhibited by different voltaic combinations*‡.” This statement I believe to be true; but in admitting and supporting it, I must guard myself from being supposed to assent to all that is associated with it in the two papers referred to, or as admitting the experiments which are

* Philosophical Transactions, 1807.

† Ibid, 1826, p. 383.

‡ Ibid. 1826, p. 389.

there quoted as decided proofs of the truth of the principle. Had I thought them so, there would have been no occasion for this investigation. It may be supposed by some that I ought to go through these papers, distinguishing what I admit from what I reject, and giving good experimental or philosophical reasons for the judgment in both cases. But then I should be equally bound to review, for the same purpose, all that has been written both for and against the necessity of metallic contact,—for and against the origin of voltaic electricity in chemical action,—a duty which I may not undertake in the present paper*.

¶ ii. *On the Intensity necessary for Electrolyzation.*

966. It became requisite, for the comprehension of many of the conditions attending voltaic action, to determine positively, if possible, whether electrolytes could resist the action of an electric current when beneath a certain intensity? whether the intensity at which the current ceased to act would be the same for all bodies? and also whether the electrolytes thus resisting decomposition would conduct the electric current as a metal does, after they ceased to conduct as electrolytes, or would act as perfect insulators?

967. It was evident from the experiments described (904. 906.) that different bodies were decomposed with very different facilities, and apparently that they required for their decomposition currents of different intensities, resisting some, but giving way to others. But it was needful, by very careful and express experiments, to determine whether a current could really pass through, and yet not decompose an electrolyte (910.).

968. An arrangement (fig. 84.) was made, in which two glass vessels contained the same dilute sulphuric acid, sp. gr. 1.25. The plate *z* was amalgamated zinc, in connexion, by a platina wire *a*, with the platina plate *e*; *b* was a platina wire connecting

* I at one time intended to introduce here, in the form of a note, a table of reference to the papers of the different philosophers who have referred the origin of the electricity in the voltaic pile to contact, or to chemical action, or to both; but on the publication of the first volume of M. Becquerel's highly important and valuable *Traité de l'Electricité et du Magnétisme*, I thought it far better to refer to that work for these references, and the views held by the authors quoted. See pages 86, 91, 104, 110, 112, 117, 118, 120, 151, 152, 224, 227, 228, 232, 233, 252, 255, 257, 258, 290, &c.—July 3rd, 1834.

the two platina plates P P'; *c* was a platina wire connected with the platina plate P". On the plate *e* was placed a piece of paper moistened in solution of iodide of potassium: the wire *c* was so curved that its end could be made to rest at pleasure on this paper, and show, by the evolution of iodine there, whether a current was passing; or, being placed in the dotted position, it formed a direct communication with the platina plate *e*, and the electricity could pass without causing decomposition. The object was to produce a current by the action of the acid on the amalgamated zinc in the first vessel A; to pass it through the acid in the second vessel B by platina electrodes, that its power of decomposing water might, if existing, be observed; and to verify the existence of the current at pleasure, by decomposition at *e*, without involving the continual obstruction to the current which would arise from making the decomposition there constant. The experiment, being arranged, was examined and the existence of a current ascertained by the decomposition at *e*; the whole was then left with the end of the wire *c* resting on the plate *e*, so as to form a constant metallic communication there.

969. After several hours, the end of the wire *c* was replaced on the test paper at *e*: decomposition occurred, and *the proof* of a passing current was therefore complete. The current was very feeble compared to what it had been at the beginning of the experiment, because of a peculiar state acquired by the metal surfaces in the second vessel, which caused them to oppose the passing current by a force which they possess under these circumstances (1040.). Still it was proved, by the decomposition, that this state of the plates in the second vessel was not able entirely to stop the current determined in the first, and that was all that was needful to be ascertained in the present inquiry.

970. This apparatus was examined from time to time, and an electric current always found circulating through it, until twelve days had elapsed, during which the water in the second vessel had been constantly subject to its action. Notwithstanding this lengthened period, not the slightest appearance of a bubble upon either of the plates in that vessel occurred. From the results of the experiment, I conclude that a current *had* passed, but of so low an intensity as to fall beneath that degree at which the elements of water, unaided by any secondary force resulting from the capability of combination with the

matter of the electrodes, or of the liquid surrounding them, separated from each other.

971. It may be supposed, that the oxygen and hydrogen had been evolved in such small quantities as to have entirely dissolved in the water, and finally to have escaped at the surface, or to have reunited into water. That the hydrogen can be so dissolved was shown in the first vessel; for after several days minute bubbles of gas gradually appeared upon a glass rod, inserted to retain the zinc and platina apart, and also upon the platina plate itself, and these were hydrogen. They resulted principally in this way:—notwithstanding the amalgamation of the zinc, the acid exerted a little direct action upon it, so that a small stream of hydrogen bubbles was continually rising from its surface; a little of this hydrogen gradually dissolved in the dilute acid, and was in part set free against the surfaces of the rod and the plate, according to the well-known action of such solid bodies in solutions of gases (623. &c.).

972. But if the gases had been evolved in the second vessel by the decomposition of water, and had tended to dissolve, still there would have been every reason to expect that a few bubbles should have appeared on the electrodes, especially on the negative one, if it were only because of its action as a nucleus on the solution supposed to be formed; but none appeared even after twelve days.

973. When a few drops only of nitric acid were added to the vessel A, fig. 84., then the results were altogether different. In less than five minutes bubbles of gas appeared on the plates P' and P'' in the second vessel. To prove that this was the effect of the electric current (which by trial at *e* was found at the same time to be passing,) the connexion at *e* was broken, the plates P' P'' cleared from bubbles and left in the acid of the vessel B, for fifteen minutes: during that time no bubbles appeared upon them; but on restoring the communication at *e*, a minute did not elapse before gas appeared in bubbles upon the plates. The proof, therefore, is most full and complete, that the current excited by dilute sulphuric acid with a little nitric acid in vessel A, has intensity enough to overcome the chemical affinity exerted between the oxygen and hydrogen of the water in the vessel B, whilst that excited by dilute sulphuric acid alone has *not* sufficient intensity.

974. On using a strong solution of caustic potassa in the vessel A, to excite the current, it was found by the decomposing effects at *e*, that the current passed. But it had not intensity enough to decompose the water in the vessel B; for though left for fourteen days, during the whole of which time the current was found to be passing, still not the slightest appearance of gas appeared on the plates P' P'', nor any other signs of the water having suffered decomposition.

975. Sulphate of soda in solution was then experimented with, for the purpose of ascertaining with respect to it, whether a certain electrolytic intensity was also required for its decomposition in this state, in analogy with the result established with regard to water (974.). The apparatus was arranged as in fig. 85; P and Z are the platina and zinc plates dipping into a solution of common salt; *a* and *b* are platina plates connected by wires of platina (except in the galvanometer *g*) with P and Z; *c* is a connecting wire of platina, the ends of which can be made to rest either on the plates *a*, *b*, or on the papers moistened in solutions which are placed upon them; so that the passage of the current without decomposition, or with one or two decompositions, was under ready command, as far as arrangement was concerned. In order to change the *anodes* and *cathodes* at the places of decomposition, the form of apparatus, fig. 86, was occasionally adopted. Here only one platina plate, *c*, was used; both pieces of paper on which decomposition was to be effected were placed upon it, the wires from P and Z resting upon these pieces of paper, or upon the plate *c*, according as the current with or without decomposition of the solutions was required.

976. On placing solution of iodide of potassium in paper at one of the decomposing localities, and solution of sulphate of soda at the other, so that the electric current should pass through both at once, the solution of iodide was slowly decomposed, yielding iodine at the *anode* and alkali at the *cathode*; but the solution of sulphate of soda exhibited no signs of decomposition, neither acid nor alkali being evolved from it. On placing the wires so that the iodide alone was subject to the action of the current (900.), it was quickly and powerfully decomposed; but on arranging them so that the sulphate of soda alone was subject to action, it still refused to yield up its elements. Finally, the apparatus was so arranged under a wet

bell-glass, that it could be left for twelve hours, the current passing during the whole time through a solution of sulphate of soda, retained in its place by only two thicknesses of bibulous litmus and turmeric paper. At the end of that time it was ascertained by the decomposition of iodide of potassium at the second place of action, that the current was passing and had passed for the twelve hours, and yet no trace of acid or alkali from the sulphate of soda appeared.

977. From these experiments it may, I think, be concluded, that a solution of sulphate of soda can conduct a current of electricity, which is unable to decompose the neutral salt present; that this salt in the state of solution, like water, requires a certain electrolytic intensity for its decomposition; and that the necessary intensity is much higher for this substance than for the iodide of potassium in a similar state of solution.

978. I then experimented on bodies rendered decomposable by fusion, and first on *chloride of lead*. The current was excited by dilute sulphuric acid without any nitric acid between zinc and platina plates, fig. 87., and was then made to traverse a little chloride of lead fused upon glass at *a*, a paper moistened in solution of iodide of potassium at *b*, and a galvanometer at *g*. The metallic terminations at *a* and *b* were of platina. Being thus arranged, the decomposition at *b* and the deflection at *g* showed that an electric current was passing, but there was no appearance of decomposition at *a*, not even after a *metallic* communication at *b* was established. The experiment was repeated several times, and I am led to conclude that in this case the current has not intensity sufficient to cause the decomposition of the chloride of lead; and further, that, like water (974.), fused chloride of lead can conduct an electric current having an intensity below that required to effect decomposition.

979. *Chloride of silver* was then placed at *a*, fig. 87., instead of chloride of lead. There was a very ready decomposition of the solution of iodide of potassium at *b*, and when metallic contact was made there, very considerable deflection of the galvanometer needle at *g*. Platina also appeared to be dissolved at the anode of the fused chloride at *a*, and there was every appearance of a decomposition having been effected there.

980. A further proof of decomposition was obtained in the following manner. The platina wires in the fused chloride at

a were brought very near together (metallic contact having been established at *b*), and left so; the deflection at the galvanometer indicated the passage of a current, feeble in its force, but constant. After a minute or two, however, the needle would suddenly be violently affected, and indicate a current as strong as if metallic contact had taken place at *a*. This I actually found to be the case, for the silver reduced by the action of the current crystallized in long delicate spiculæ, and these at last completed the metallic communication; and at the same time that they transmitted a more powerful current than the fused chloride, they proved that electro-chemical decomposition of that chloride had been going on. Hence it appears, that the current excited by dilute sulphuric acid between zinc and platina, has an intensity above that required to electrolyze the fused chloride of silver when placed between platina electrodes, although it has not intensity enough to decompose chloride of lead under the same circumstances.

981. A drop of *water* placed at *a* instead of the fused chlorides, showed as in the former case (970.), that it could conduct a current unable to decompose it, for decomposition of the solution of iodide at *b* occurred after some time. But its conducting power was much below that of the fused chloride of lead (978.).

982. Fused *nitre* at *a* conducted much better than water: I was unable to decide with certainty whether it was electrolyzed, but I incline to think not, for there was no discoloration against the platina at the *cathode*. If sulpho-nitric acid had been used in the exciting vessel, both the nitre and the chloride of lead would have suffered decomposition like the water (906.).

983. The results thus obtained of conduction without decomposition, and the necessity of a certain electrolytic intensity for the separation of the *ions* of different electrolytes, are immediately connected with the experiments and results given in § 10. of the Fourth Series of these Researches (418. 423. 444. 449.). But it will require a more exact knowledge of the nature of intensity, both as regards the first origin of the electric current, and also the manner in which it may be reduced, or lowered by the intervention of longer or shorter portions of bad conductors, whether decomposable or not, before their relation can be minutely and fully understood.

984. In the case of water, the experiments I have as yet

made, appear to show, that, when the electric current is reduced in intensity below the point required for decomposition, then the degree of conduction is the same whether sulphuric acid, or any other of the many bodies which can affect its transferring power as an electrolyte, are present or not. Or, in other words, that the necessary electrolytic intensity for water is the same whether it be pure, or rendered a better conductor by the addition of these substances; and that for currents of less intensity than this, the water, whether pure or acidulated, has equal conducting power. An apparatus, fig. 84, was arranged with dilute sulphuric acid in the vessel A, and pure distilled water in the vessel B. By the decomposition at *e*, it appeared as if water was a *better* conductor than dilute sulphuric acid for a current of such low intensity as to cause no decomposition. I am inclined, however, to attribute this apparent superiority of water to variations in that peculiar condition of the platina electrodes which is referred to further on in this Series (1040.), and which is assumed, as far as I can judge, to a greater degree in dilute sulphuric acid than in pure water. The power therefore, of acids, alkalies, salts, and other bodies in solution, to increase conducting power, appears to hold good only in those cases where the electrolyte subject to the current suffers decomposition, and loses all influence when the current transmitted has too low an intensity to affect chemical change. It is probable that the ordinary conducting power of an electrolyte in the solid state (419.) is the same as that which it possesses in the fluid state for currents the tension of which is beneath the due electrolytic intensity.

985. Currents of electricity, produced by less than eight or ten series of voltaic elements, can be reduced to that intensity at which water can conduct them without suffering decomposition, by causing them to pass through three or four vessels in which water shall be successively interposed between platina surfaces. The principles of interference upon which this effect depends, will be described hereafter (1009. 1018.), but the effect may be useful in obtaining currents of standard intensity, and is probably applicable to batteries of any number of pairs of plates.

986. As there appears every reason to expect that all electrolytes will be found subject to the law which requires an electric current of a certain intensity for their decomposition,

but that they will differ from each other in the degree of intensity required, it will be desirable hereafter to arrange them in a table, in the order of their electrolytic intensities. Investigations on this point must, however, be very much extended, and include many more bodies than have been here mentioned before such a table can be constructed. It will be especially needful in such experiments, to describe the nature of the electrodes used, or, if possible, to select such as, like platina or plumbago in certain cases, shall have no power of assisting the separation of the *ions* to be evolved (913.).

987. Of the two modes in which bodies can transmit the electric forces, namely, that which is so characteristically exhibited by the metals, and usually called conduction, and that in which it is accompanied by decomposition, the first appears common to all bodies, although it occurs with almost infinite degrees of difference; the second is at present distinctive of the electrolytes. It is, however, just possible that it may hereafter be extended to the metals; for their power of conducting without decomposition may, perhaps justly, be ascribed to their requiring a very high electrolytic intensity for their decomposition.

987½. The establishment of the principle that a certain electrolytic intensity is necessary before decomposition can be effected, is of great importance to all those considerations which arise regarding the probable effects of weak currents, such for instance as those produced by natural thermo-electricity, or natural voltaic arrangements in the earth. For to produce an effect of decomposition or of combination, a current must not only exist, but have a certain intensity before it can overcome the quiescent affinities opposed to it, otherwise it will be conducted, producing no permanent chemical effects. On the other hand, the principles are also now evident by which an opposing action can be so weakened by the juxtaposition of bodies not having quite affinity enough to cause direct action between them (913.), that a very weak current shall be able to raise the sum of actions sufficiently high, and cause chemical changes to occur.

988. In concluding this division *on the intensity necessary for electrolyzation*, I cannot resist pointing out the following remarkable conclusion in relation to intensity generally. It would appear that when a voltaic current is produced, having

a certain intensity, dependent upon the strength of the chemical affinities by which that current is excited (916.), it can decompose a particular electrolyte without relation to the quantity of electricity passed, the *intensity* deciding whether the electrolyte shall give way or not. If that conclusion be confirmed, then we may arrange circumstances so that the *same quantity* of electricity may pass in the *same time*, in at the *same surface*, into the *same decomposing body in the same state*, and yet, differing in intensity, will *decompose in one case and in the other not* :—for taking a source of too low an intensity to decompose, and ascertaining the quantity passed in a given time, it is easy to take another source having a sufficient intensity, and reducing the quantity of electricity from it by the intervention of bad conductors to the same proportion as the former current, and then all the conditions will be fulfilled which are required to produce the result described.

¶ iii. *On associated Voltaic circles, or the Voltaic battery.*

989. Passing from the consideration of single circles (875. &c.) to their association in the voltaic battery, it is a very evident consequence, that if matters are so arranged that two sets of affinities, in place of being opposed to each other as in figg. 73. 76. (880. 891.), are made to act in conformity, then, instead of either interfering with the other, it will rather assist it. This is simply the case of two voltaic pairs of metals arranged so as to form one circuit. In such arrangements the activity of the whole is known to be increased, and when ten, or a hundred, or any larger number of such alterations are placed in conformable association with each other, the power of the whole becomes proportionably exalted, and we obtain that magnificent instrument of philosophic research, the *voltaic battery*.

990. But it is evident from the principles of definite action already laid down, that the *quantity* of electricity in the current cannot be increased with the increase of the *quantity of metal* oxidized and dissolved at each new place of chemical action. A single pair of zinc and platina plates throws as much electricity into the form of a current, by the oxidation of 32·5 grains of the zinc (868.) as would be circulated by the same alteration of a thousand times that quantity, or nearly five pounds of metal oxidized at the surface of the zinc plates

of a thousand pairs placed in regular battery order. For it is evident, that the electricity which passes across the acid from the zinc to the platina in the first cell, and which has been associated with, or even evolved by, the decomposition of a definite portion of water in that cell, cannot pass from the zinc to the platina across the acid in the second cell, without the decomposition of the same quantity of water there, and the oxidation of the same quantity of zinc by it (924. 949.). The same result recurs in every other cell; the electro-chemical equivalent of water must be decomposed in each, before the current can pass through it; for the quantity of electricity passed and the quantity of electrolyte decomposed, *must* be the equivalents of each other. The action in each cell, therefore, is not to increase the quantity set in motion in any one cell, but to aid in urging forward that quantity, the passing of which is consistent with the oxidation of its own zinc; and in this way it exalts that peculiar property of the current which we endeavour to express by the term *intensity*, without increasing the *quantity* beyond that which is proportionate to the quantity of zinc oxidized in any single cell of the series.

991. To prove this, I arranged ten pairs of amalgamated zinc and platina plates with dilute sulphuric acid in the form of a battery. On completing the circuit, all the pairs acted and evolved gas at the surfaces of the platina. This was collected and found to be alike in quantity for each plate; and the quantity of hydrogen evolved at any one platina plate was in the same proportion to the quantity of metal dissolved from any one zinc plate, as was given in the experiment with a single pair (864. &c.). It was therefore certain, that, just as much electricity and no more had passed through the series of ten pair of plates as had passed through, or would have been put into motion by, any single pair, notwithstanding that ten times the quantity of zinc had been consumed.

992. This truth has been proved also long ago in another way, by the action of the evolved current on a magnetic needle; the deflecting power of one pair of plates in a battery being equal to the deflecting power of the whole, provided the wires used be sufficiently large to carry the current of the single pair freely; but the *cause* of this equality of action could not be

understood whilst the definite action and evolution of electricity (783. 869.) remained unknown.

993. The superior decomposing power of a battery over a single pair of plates is rendered evident in two ways. Electrolytes held together by an affinity so strong as to resist the action of the current from a single pair, yield up their elements to the current excited by many pairs ; and that body which is decomposed by the action of one or of few pairs of metals, &c., is resolved into its *ions* the more readily as it is acted upon by electricity urged forward by many alternations.

994. Both these effects are, I think, easily understood. Whatever *intensity* may be, (and that must of course depend upon the nature of electricity, whether it consist of a fluid or fluids, or of vibrations of an ether, or any other kind or condition of matter,) there seems to be no difficulty in comprehending that the *degree* of intensity at which a current of electricity is evolved by a first voltaic element, shall be increased when that current is subjected to the action of a second voltaic element, acting in conformity and possessing equal powers with the first : and as the decompositions are merely opposed actions, but exactly of the same kind as those which generate the current (917.), it seems to be a natural consequence, that the affinity which can resist the force of a single decomposing action may be unable to oppose the energies of many decomposing actions, operating conjointly, as in the voltaic battery.

995. That a body which can give way to a current of feeble intensity, should give way more freely to one of stronger force, and yet involve no contradiction to the law of definite electrolytic action, is perfectly consistent. All the facts and also the theory I have ventured to put forth, tend to show that the act of decomposition opposes a certain force to the passage of the electric current ; and, that this obstruction should be overcome more or less readily, in proportion to the greater or less intensity of the decomposing current, is in perfect consistency with all our notions of the electric agent.

996. I have elsewhere (947.) distinguished the chemical action of zinc and dilute sulphuric acid into two portions ; that which, acting effectually on the zinc, evolves hydrogen at once

upon its surface, and that which, producing an arrangement of the chemical forces throughout the electrolyte present, (in this case water,) tends to take oxygen from it, but cannot do so unless the electric current consequent thereon can have free passage, and the hydrogen be delivered elsewhere than against the zinc. The electric current depends altogether upon the second of these; but when the current can pass, by favouring the electrolytic action it tends to diminish the former and increase the latter portion.

997. It is evident, therefore, that when ordinary zinc is used in a voltaic arrangement, there is an enormous waste of that power which it is the object to throw into the form of an electric current; a consequence which is put in its strongest point of view when it is considered that three ounces and a half of zinc, properly oxydized, can circulate enough electricity to decompose nearly one ounce of water, and cause the evolution of about 2400 cubic inches of hydrogen gas. This loss of power not only takes place during the time the electrodes of the battery are in communication, being then proportionate to the quantity of hydrogen evolved against the surface of any one of the zinc plates, but includes also *all* the chemical action which goes on when the extremities of the pile are not in communication.

998. This loss is far greater with ordinary zinc than with the pure metal, as M. De la Rive has shown*. The cause is, that when ordinary zinc is acted upon by dilute sulphuric acid, portions of copper, lead, cadmium, or other metals which it may contain, are set free upon its surface; and these, being in contact with the zinc, form small but very active voltaic circles, which cause great destruction of the zinc and evolution of hydrogen, apparently upon the zinc surface, but really upon the surface of these incidental metals. In the same proportion as they serve to discharge or convey the electricity back to the zinc, do they diminish its power of producing an electric current which shall extend to a greater distance across the acid, and be discharged only through the copper or platina plate which is associated with it for the purpose of forming a voltaic apparatus.

* Quarterly Journal of Science, 1831, p. 388; or Bibliothèque Universelle, 1830, p. 391.

999. All these evils are removed by the employment of an amalgam of zinc in the manner recommended by Mr. Kemp*, or the use of the amalgamated zinc plates of Mr. Sturgeon (863.), who has himself suggested and objected to their application in galvanic batteries; for he says, "Were it not on account of the brittleness and other inconveniences occasioned by the incorporation of the mercury with the zinc, amalgamation of the zinc surfaces in galvanic batteries would become an important improvement; for the metal would last much longer, and remain bright for a considerable time, even for several successive hours; essential considerations in the employment of this apparatus." †

1000. Zinc so prepared, even though impure, does not sensibly decompose the water of dilute sulphuric acid, but still has such affinity for the oxygen, that the moment a metal which, like copper or platina, has little or no affinity, touches it in the acid, action ensues, and a powerful and abundant electric current is produced. It is probable that the mercury acts by bringing the surface, in consequence of its fluidity, into one uniform condition, and preventing those differences in character between one spot and another which are necessary for the formation of the minute voltaic circuits referred to (998.). If any difference does exist at the first moment, with regard to the proportion of zinc and mercury, at one spot on the *surface*, as compared with another, that spot having the least mercury is first acted on, and, by solution of the zinc, is soon placed in the same condition as the other parts, and the whole plate rendered superficially uniform. One part cannot, therefore, act as a discharger to another; and hence *all* the chemical power upon the water at its surface is in that equable condition (949.), which, though it tends to produce an electric current through the liquid to another plate of metal which can act as a discharger (950.), present no irregularities by which any one part, having weaker affinities for oxygen, can act as a discharger to another. Two excellent and important consequences follow

* Jameson's Edinburgh Journal, October 1828.

† Recent Experimental Researches, p. 42, &c. Mr. Sturgeon is of course unaware of the definite production of electricity by chemical action, and is in fact quoting the experiment as the strongest argument *against* the chemical theory of galvanism.

upon this state of the metal. The first is, that the *full equivalent* of electricity is obtained for the oxidation of a certain quantity of zinc; the second, that a battery constructed with the zinc so prepared, and charged with dilute sulphuric acid, is active only whilst the electrodes are connected, and ceases to act or be acted upon by the acid the instant the communication is broken.

1001. I have had a small battery of ten pairs of plates thus constructed, and am convinced that arrangements of this kind will be very important, especially in the development and illustration of the philosophical principles of the instrument. The metals I have used are amalgamated zinc and platina, connected together by being soldered to platina wires, the whole apparatus having the form of the *couronne des tasses*. The liquid used was dilute sulphuric acid of sp. gr. 1.25. No action took place upon the metals except when the electrodes were in communication, and then the action upon the zinc was only in proportion to the decomposition in the experimental cell; for when the current was retarded there, it was retarded also in the battery, and no waste of the powers of the metal was incurred.

1002. In consequence of this circumstance, the acid in the cells remained active for a very much longer time than usual. In fact, time did not tend to lower it in any sensible degree: for whilst the metal was preserved to be acted upon at the proper moment, the acid also was preserved almost at its first strength. Hence a constancy of action far beyond what can be obtained by the use of common zinc.

1003. Another excellent consequence was the renewal, during the interval of rest, between two experiments of the first and most efficient state. When an amalgamated zinc and a platina plate, immersed in dilute sulphuric acid, are first connected, the current is very powerful, but instantly sinks very much in force, and in some cases actually falls to only an eighth or a tenth of that first produced (1036.). This is due to the acid which is in contact with the zinc becoming neutralized by the oxide formed; the continued quick oxidation of the metal being thus prevented. With ordinary zinc, the evolution of gas at its surface tends to mingle all the liquid together, and thus bring fresh acid against the metal, by which the

oxide formed there can be removed. With the amalgamated zinc battery, at every cessation of the current, the saline solution against the zinc is gradually diffused amongst the rest of the liquid; and upon the renewal of contact at the electrodes, the zinc plates are found most favourably circumstanced for the production of a ready and powerful current.

1004. It might at first be imagined that amalgamated zinc would be much inferior in force to common zinc, because of the lowering of its energy, which the mercury might be supposed to occasion over the whole of its surface; but this is not the case. When the electric currents of two pairs of platinum and zinc plates were opposed, the difference being that one of the zincs was amalgamated and the other not, the current from the amalgamated zinc was most powerful, although no gas was evolved against it, and much was evolved at the surface of the unamalgamated metal. Again, as Davy has shown*, if amalgamated and unamalgamated zinc be put in contact, and dipped into dilute sulphuric acid, or other exciting fluids, the former is positive to the latter, *i. e.* the current passes from the amalgamated zinc, through the fluid, to the unprepared zinc. This he accounts for by supposing that "there is not any inherent and specific property in each metal which gives it the electrical character, but that it depends upon its peculiar state—on that form of aggregation which fits it for chemical change."

1005. The superiority of the amalgamated zinc is not, however, due to any such cause, but is a very simple consequence of the state of the fluid in contact with it; for as the unprepared zinc acts directly and alone upon the fluid, whilst that which is amalgamated does not, the former (by the oxide it produces) quickly neutralizes the acid in contact with its surface, so that the progress of oxidation is retarded, whilst at the surface of the amalgamated zinc, any oxide formed is instantly removed by the free acid present, and the clean metallic surface is always ready to act with full energy upon the water. Hence its superiority (1037.).

1006. The progress of improvement in the voltaic battery and its applications, is evidently in the contrary direction at present to what it was a few years ago; for in place of increasing

* Philosophical Transactions, 1826, p. 405.

the number of plates, the strength of acid, and the extent altogether of the instrument, the change is rather towards its first state of simplicity, but with a far more intimate knowledge and application of the principles which govern its force and action. Effects of decomposition can now be obtained with ten pairs of plates (417.), which required five hundred or a thousand pairs for their production in the first instance. The capability of decomposing fused chlorides, iodides, and other compounds, according to the law before established (380. &c.), and the opportunity of collecting certain of the products, without any loss, by the use of apparatus of the nature of those already described (789. 814. &c.), render it probable that the voltaic battery may become a useful and even economical manufacturing instrument; for theory evidently indicates that an equivalent of a rare substance may be obtained at the expense of three or four equivalents of a very common body, namely, zinc: and practice seems thus far to justify the expectation. In this point of view I think it very likely that plates of platina or silver may be used instead of plates of copper with advantage, and that then the evil arising occasionally from solution of the copper, and its precipitation on the zinc, (by which the electro-motive power of the zinc is so much injured,) will be avoided (1047.).

¶ iv. *On the resistance of an Electrolyte to Electrolytic Action and on Interpositions.*

1007. I have already illustrated, in the simplest possible form of experiment (891. 910.), the resistance established at the place of decomposition to the force active at the exciting place. I purpose examining the effects of this resistance more generally; but it is rather with reference to their practical interference with the action and phenomena of the voltaic battery, than with any intention at this time to offer a strict and philosophical account of their nature. Their general and principal cause is the resistance of the chemical affinities to be overcome; but there are numerous other circumstances which have a joint influence with these forces (1034. 1040. &c.), each of which would require a minute examination before a correct account of the whole could be given.

1008. As it will be convenient to describe the experiments

in a form different to that in which they were made, both forms shall first be explained. Plates of platina, copper, zinc, and other metals, about three quarters of an inch wide and three inches long, were associated together in pairs by means of platina wires to which they were soldered, fig. 88, the plates of one pair being either alike or different, as might be required. These were arranged in glasses, fig. 89, so as to form Volta's crown of cups. The acid or fluid in the cups never covered the whole of any plate; and occasionally small glass rods were put into the cups, between the plates, to prevent their contact. Single plates were used to terminate the series and complete the connection with a galvanometer, or with a decomposing apparatus (899. 968. &c.), or both. Now if fig. 90 be examined and compared with fig. 91, the latter may be admitted as representing the former in its simplest condition; for the cups i, ii, and iii of the former, with their contents, are represented by the cells i, ii, and iii, of the latter, and the metal plates Z and P of the former by the similar plates represented Z and P in the latter. The only difference, in fact, between the apparatus, fig. 90, and the trough represented fig. 91, is that twice the quantity of surface of contact between the metal and acid is allowed in the first to what would occur in the second.

1009. When the extreme plates of the arrangement just described, fig. 90, are connected metallically through the galvanometer *g*, then the whole represents a battery consisting of two pairs of zinc and platina plates urging a current forward, which has, however, to decompose water unassisted by any direct chemical affinity before it can be transmitted across the cell iii, and therefore before it can circulate. This decomposition of water, which is opposed to the passage of the current, may, as a matter of convenience, be considered as taking place either against the surfaces of the two platina plates which constitute the electrodes in the cell iii, or against the two surfaces of that platina plate which separates the cells ii and iii, fig. 91, from each other. It is evident that if that plate were away, the battery would consist of two pairs of plates and two cells, arranged in the most favourable position for the production of a current. The platina plate therefore, which being introduced as at *x*, has oxygen evolved at one surface and hydrogen at the other

(that is, if the decomposing current passes), may be considered as the cause of any obstruction arising from the decomposition of water by the electrolytic action of the current; and I have usually called it the interposed plate.

1010. In order to simplify the conditions, dilute sulphuric acid was first used in all the cells, and platina for the interposed plates; for then the initial intensity of the current which tends to be formed is constant, being due to the power which zinc has of decomposing water; and the opposing force of decomposition is also constant, the elements of the water being unassisted in their separation at the interposed plates by any affinity or secondary action at the electrodes (744.), arising either from the nature of the plate itself or the surrounding fluid.

1011. When only one voltaic pair of zinc and platina plates was used, the current of electricity was entirely stopped to all practical purposes by interposing one platina plate, fig. 92, *i. e.* by requiring of the current that it should decompose water, and evolve both its elements, before it should pass. This consequence is in perfect accordance with the views before given (910. 917. 973.). For as the whole result depends upon the opposition of forces at the places of electric excitement and electro-decomposition, and as water is the substance to be decomposed at both before the current can move, it is not to be expected that the zinc should have such powerful attraction for the oxygen, as not only to be able to take it from its associated hydrogen, but leave such a surplus of force as, passing to the second place of decomposition, should be there able to effect a second separation of the elements of water. Such an effect would require that the force of attraction between zinc and oxygen should under the circumstances be *at least* twice as great as the force of attraction between the oxygen and hydrogen.

1012. When two pairs of zinc and platina exciting plates were used, the current was also practically stopped by one interposed platina plate, fig. 93. There was a very feeble effect of a current at first, but it ceased almost immediately. It will be referred to, with many other similar effects, hereafter (1017.).

1013. Three pairs of zinc and platina plates, fig. 94, were able

to produce a current which could pass an interposed platina plate, and effect the electrolyzation of water in cell iv. The current was evident, both by the continued deflexion of the galvanometer, and the production of bubbles of oxygen and hydrogen at the electrodes in cell iv. Hence the accumulated surplus force of three plates of zinc, which are active in decomposing water, is more than equal, when added together, to the force with which oxygen and hydrogen are combined in water, and is sufficient to cause the separation of these elements from each other.

1014. The three pairs of zinc and platina plates were now opposed by two intervening platina plates, fig. 95. In this case the current was stopped.

1015. Four pairs of zinc and platina plates were also neutralized by two interposed platina plates, fig. 96.

1016. Five pairs of zinc and platina, with two interposed platina plates, fig. 97, gave a feeble current; there was permanent deflexion at the galvanometer, and decomposition in the cells vi and vii. But the current was very feeble; very much less than when all the intermediate plates were removed and the two extreme ones only retained: for when they were placed six inches asunder in one cell, they gave a powerful current. Hence five exciting pairs, with two interposed obstructing plates, do not give a current at all comparable to that of a single unobstructed pair.

1017. I have already said that a *very feeble current* passed when the series included one interposed platina and two pairs of zinc and platina plates (1012.). A similarly feeble current passed in every case, and even when only one exciting pair and four intervening platina plates were used, fig. 98, a current passed which could be detected at x , both by chemical action on the solution of iodide of potassium, and by the galvanometer. This current I believe to be due to electricity reduced in intensity below the point requisite for the decomposition of water (970. 984.); for water can conduct electricity of such low intensity by the same kind of power which it possesses in common with metals and charcoal, though it cannot conduct electricity of higher intensity without suffering decomposition, and then opposing a new force consequent thereon. With an

electric current of, or under this intensity, it is probable that increasing the number of interposed platina plates would not involve an increased difficulty of conduction.

1018. In order to obtain an idea of the additional interfering power of each added platina plate, six voltaic pairs and four intervening platinas were arranged as in fig. 99; a very feeble current then passed (985. 1017.). When one of the platinas was removed so that three intervened, a current somewhat stronger passed. With two intervening platinas a still stronger current passed; and with only one intervening platina a very fair current was obtained. But the effect of the successive plates, taken in the order of their interposition, was very different, as might be expected; for the first retarded the current more powerfully than the second, and the second more than the third.

1019. In these experiments both amalgamated and unamalgamated zinc were used, but the results generally were the same.

1020. The effects of retardation just described were altered altogether when changes were made in the *nature of the liquid* used between the plates, either in what may be called the *exciting* or the *retarding* cells. Thus, retaining the exciting force the same, by still using pure dilute sulphuric acid for that purpose, if a little nitric acid were added to the liquid in the *retarding* cells, then the transmission of the current was very much facilitated. For instance, in the experiment with one pair of exciting plates and one intervening plate (1011.) fig. 92, when a few drops of nitric acid were added to the contents of cell ii, then the current of electricity passed with considerable strength (though it soon fell from other causes (1036. 1040.)) and the same increased effect was produced by the nitric acid when many interposed plates were used.

1021. This seems to be a consequence of the diminution of the difficulty of decomposing water when its hydrogen, instead of being absolutely expelled, as in the former cases, is transferred to the oxygen of the nitric acid, producing a secondary result at the *cathode* (752.); for, in accordance with the chemical views of the electric current and its action already advanced (913.), the water, instead of opposing a resistance to decomposition equal to the full amount of the force of mutual at-

traction between its oxygen and hydrogen, has that force counteracted in part, and therefore diminished by the attraction of the hydrogen at the *cathode* for the oxygen of the nitric acid which surrounds it, and with which it ultimately combines instead of being evolved in its free state.

1022. When a little nitric acid was put into the exciting cells, then again the circumstances favouring the transmission of the current were strengthened, for the *intensity* of the current itself was increased by the addition (906.). When therefore a little nitric acid was added to both the *exciting* and the *retarding* cells, the current of electricity passed with very considerable freedom.

1023. When dilute muriatic acid was used, it produced and transmitted a current more easily than pure dilute sulphuric acid, but not so readily as dilute nitric acid. As muriatic acid appears to be decomposed more freely than water (765.), and as the affinity of zinc for chlorine is very powerful, it might be expected to produce a current more intense than that from the use of dilute sulphuric acid; and also to transmit it more freely by undergoing decomposition at a lower intensity (912.).

1024. In relation to the effect of these interpositions, it is necessary to state that they do not appear to be at all dependent upon the size of the electrodes, or their distance from each other in the acid, except that when a current *can pass*, changes in these facilitate or retard its passage. For on repeating the experiment with one intervening and one pair of exciting plates (1011.), fig. 92, and in place of the interposed plate P using sometimes a mere wire, and sometimes very large plates (1008.), and also changing the terminal exciting plates Z and P, so that they were sometimes wires only and at others of great size, still the results were the same as those already obtained.

1025. In illustration of the effect of distance, an experiment like that described with two exciting pairs and one intervening plate (1012), fig. 93, was arranged so that the distance between the plates in the third cell could be increased to six or eight inches, or diminished to the thickness of a piece of intervening bibulous paper. Still the result was the same in both cases, the effect not being sensibly greater, when the plates were merely separated by the paper, than when a great way apart; so that the principal opposition to the current in this

case does not depend upon the *quantity* of intervening electrolytic conductor, but on the *relation of its elements to the intensity of the current*, or to the chemical nature of the electrodes and the surrounding fluids.

1026. When the acid was sulphuric acid, *increasing its strength* in any of the cells, caused no change in the effects; it did not produce a more intense current in the exciting cells (908.), or cause the current produced to traverse the decomposing cells more freely. But if to very weak sulphuric acid a few drops of nitric acid were added, then either one or other of those effects could be produced; and, as might be expected in a case like this, where the exciting or conducting action bore a *direct* reference to the acid itself, increasing the strength of this (the nitric acid), also increased its powers.

1027. The *nature of the interposed plate* was now varied to show its relation to the phenomena either of excitation or retardation, and amalgamated zinc was first substituted for platinum. On employing one voltaic pair and one interposed zinc plate, fig. 100, there was as powerful a current, apparently, as if the interposed zinc plate was away. Hydrogen was evolved against P in cell ii, and against the side of the second zinc in cell i; but no gas appeared against the side of the zinc in cell ii, nor against the zinc in cell i.

1028. On interposing two amalgamated zinc plates, fig. 101, instead of one, there was still a powerful current, but interference had taken place. On using three intermediate zinc plates, fig. 102, there was still further retardation, though a good current of electricity passed.

1029. Considering the retardation as due to the inaction of the amalgamated zinc upon the dilute acid, in consequence of the slight though general effect of diminished chemical power produced by the mercury on the surface, and viewing this inaction as the circumstance which rendered it necessary that each plate should have its tendency to decompose water assisted slightly by the electric current, it was expected that plates of the metal in the unamalgamated state would probably not require such assistance, and would offer no sensible impediment to the passing of the current. This expectation was fully realized in the use of two and three interposed unamalgamated plates. The electric current passed through them as

freely as if there had been no such plates in the way. They offered no obstacle, because they could decompose water without the current; and the latter had only to give direction to a part of the forces, which would have been active whether it had passed or not.

1030. Interposed plates of copper were then employed. These seemed at first to occasion no obstruction, but after a few minutes the current almost entirely ceased. This effect appears due to the surfaces taking up that peculiar condition (1040.) by which they tend to produce a reverse current; for when one or more of the plates were turned round, which could easily be effected with the couronne des tasses form of experiment, fig. 90, then the current was powerfully renewed for a few moments, and then again ceased. Plates of platina and copper, arranged as a voltaic pile with dilute sulphuric acid, could not form a voltaic trough competent to act for more than a few minutes, because of this peculiar counteracting effect.

1031. All these effects of retardation, exhibited by decomposition against surfaces for which the evolved elements have more or less affinity, or are altogether deficient in attraction, show generally, though beautifully, the chemical relations and source of the current, and also the balanced state of the affinities at the places of excitation and decomposition. In this way they add to the mass of evidence in favour of the identity of the two; for they demonstrate, as it were, the antagonism of the *chemical powers* at the electromotive part with the *chemical powers* at the interposed parts; they show that the first are *producing* electric effects, and the second *opposing* them; they bring the two into direct relation; they prove that either can determine the other, thus making what appears to be cause and effect convertible, and thereby demonstrating that both chemical and electrical action are merely two exhibitions of one single agent or power (916. &c.).

1032. It is quite evident, that as water and other electrolytes can conduct electricity without suffering decomposition (986.), when the electricity is of sufficiently low intensity, it may not be asserted as absolutely true in all cases, that whenever electricity passes through an electrolyte, it produces a definite effect of decomposition. But the quantity of electricity which

can pass in a given time through an electrolyte without causing decomposition, is so small as to bear no comparison to that required in a case of very moderate decomposition, and with electricity above the intensity required for electrolyzation, I have found no sensible departure as yet from the law of *definite electrolytic action* developed in the preceding series of these Researches (783. &c.).

1033. I cannot dismiss this division of the present Paper without making a reference to the important experiments of M. Aug. De la Rive on the effects of interposed plates*. As I have had occasion to consider such plates merely as giving rise to new decompositions, and in that way only causing obstruction to the passage of the electric current, I was freed from the necessity of considering the peculiar effects described by that philosopher. I was the more willing to avoid for the present touching upon these, as I must at the same time have entered into the views of Sir Humphry Davy upon the same subject†, and also those of Marianini‡ and Ritter§, which are connected with it.

¶ v. *General Remarks on the active Voltaic Battery.*

1034. When the ordinary voltaic battery is brought into action, its very activity produces certain effects, which react upon it, and cause serious deterioration of its power. These render it an exceedingly inconstant instrument as to the *quantity* of effect which it is capable of producing. They are already, in part, known and understood; but as their importance, and that of certain other coincident results, will be more evident by reference to the principles and experiments already stated and described, I have thought it would be useful, in this investigation of the voltaic pile, to notice them briefly here.

1035. When the battery is in action, it causes such substances to be formed and arranged in contact with the plates as very much weaken its power, or even tend to produce a counter current. They are considered by Sir Humphry Davy as sufficient to account for the phenomena of Ritter's secondary

* Annales de Chimie, tom. xxviii. p. 190; and Mémoires de Genève.

† Philosophical Transactions, 1826, p. 413.

‡ Annales de Chimie, tom. xxxiii. pp. 117, 119, &c.

§ Journal de Physique, tom. lvii. pp. 349, 350.

piles, and also for the effects observed by M. A. De la Rive with interposed platina plates*.

1036. I have already referred to this consequence (1003.), as capable, in some cases, of lowering the force of the current to one eighth or one tenth of what it was at the first moment, and have met with instances in which its interference was very great. In an experiment in which one voltaic pair and one interposed platina plate were used with dilute sulphuric acid in the cells fig. 103., the wires of communication were so arranged, that the end of that marked 3 could be placed at pleasure upon paper moistened in the solution of iodide of potassium at *x*, or directly upon the platina plate there. If, after an interval during which the circuit had not been complete, the wire 3 were placed upon the paper, there was evidence of a current, decomposition ensued, and the galvanometer was affected. If the wire 3 were made to touch the metal of *p*, a comparatively strong sudden current was produced, affecting the galvanometer, but lasting only for a moment; the effect at the galvanometer ceased, and if the wire 3 were placed on the paper at *x*, no signs of decomposition occurred. On raising the wire 3, and breaking the circuit altogether for a while, the apparatus resumed its first power, requiring, however, from five to ten minutes for this purpose; and then, as before, on making contact between 3 and *p*, there was again a momentary current, and immediately all the effects apparently ceased.

1037. This effect I was ultimately able to refer to the state of the film of fluid in contact with the zinc plate in cell i. The acid of that film is instantly neutralized by the oxide formed; the oxidation of the zinc cannot, of course, go on with the same facility as before; and the chemical action being thus interrupted, the voltaic action diminishes with it. The time of the rest was required for the diffusion of the liquid, and its replacement by other acid. From the serious influence of this cause in experiments with single pairs of plates of different metals, in which I was at one time engaged, and the extreme care required to avoid it, I cannot help feeling a strong suspicion that it interferes more frequently and extensively than

* Philosophical Transactions, 1826, p. 413.

experimenters are aware of, and therefore direct their attention to it.

1038. In considering the effect in delicate experiments of this source of irregularity of action in the voltaic apparatus, it must be remembered that it is only that very small portion of matter which is directly in contact with the oxidizable metal which has to be considered with reference to the change of its nature; and this portion is not very readily displaced from its position upon the surface of the metal (582. 605.), especially if that metal be rough and irregular. In illustration of this effect, I will quote a remarkable experiment. A burnished platina plate (569.) was put into hot strong sulphuric acid for an instant only: it was then put into distilled water, moved about in it, taken out, and wiped dry: it was put into a second portion of distilled water, moved about in it, and again wiped: it was put into a third portion of distilled water, in which it was moved about for nearly eight seconds; it was then, without wiping, put into a fourth portion of distilled water, where it was allowed to remain five minutes. The two latter portions of water were then tested for sulphuric acid; the third gave no sensible appearance of that substance, but the fourth gave indications which were not merely evident, but abundant for the circumstances under which it had been introduced. The result sufficiently shows with what difficulty that portion of the substance which is in *contact* with the metal leaves it; and as the contact of the fluid formed against the plate in the voltaic circuit must be as intimate and as perfect as possible, it is easy to see how quickly and greatly it must vary from the general fluid in the cells, and how influential in diminishing the force of the battery this effect must be.

1039. In the ordinary voltaic pile, the influence of this effect will occur in all variety of degrees. The extremities of a trough of twenty pairs of plates of Wollaston's construction were connected with the volta-electrometer, fig. 66. (711.), of the Seventh Series of these Researches, and after five minutes the number of bubbles of gas issuing from the extremity of the tube, in consequence of the decomposition of the water, noted. Without moving the plates, the acid between the copper and zinc was agitated by the introduction of a feather. The bubbles were immediately evolved more rapidly, above twice the num-

ber being produced in the same portion of time as before. In this instance it is very evident that agitation by a feather must have been a very imperfect mode of restoring the acid in the cells against the plates towards its first equal condition; and yet imperfect as the means were, they more than doubled the power of the battery. The *first effect* of a battery which is known to be so superior to the degree of action which the battery can sustain, is almost entirely due to the favourable condition of the acid in contact with the plates.

1040. A *second* cause of diminution in the force of the voltaic battery, consequent upon its own action, is that extraordinary state of the surfaces of the metals (969.) which was first described, I believe, by Ritter*, to which he refers the powers of his secondary piles, and which has been so well experimented upon by Marianini, and also by A. De la Rive. If the apparatus, fig. 103. (1036.), be left in action for an hour or two, with the wire 3 in contact with the plate *p*, so as to allow a free passage for the current, then, though the contact be broken for ten or twelve minutes, still, upon its renewal, only a feeble current will pass, not at all equal in force to what might be expected. Further, if P^1 and P^2 be connected by a metal wire, a powerful momentary current will pass from P^2 to P^1 through the acid, and therefore in the reverse direction to that produced by the action of the zinc in the arrangement; and after this has happened, the general current can pass through the whole of the system as at first, but by its passage again restores the plates P^2 and P^1 into the former opposing condition. This, generally, is the fact described by Ritter, Marianini, and De la Rive. It has great opposing influence on the action of a pile, especially if the latter consist of but a small number of alternations, and has to pass its current through many interpositions. It varies with the solution in which the interposed plates are immersed, with the intensity of the current, the strength of the pile, the time of action, and especially with accidental discharges of the plates by inadvertent contacts or reversions of the plates during experiments, and must be carefully watched in every endeavour to trace the source, strength, and variations of the voltaic current. Its effect was avoided in the experiments already described (1036. &c.), by making contact be-

* Journal de Physique, lvii. p. 349.

tween the plates P^1 and P^2 before the effect dependent upon the state of the solution in contact with the zinc plate was observed, and by other precautions.

1041. When an apparatus like fig. 98. (1017.) with several platina plates was used, being connected with a battery able to force a current through them, the power which they acquired, of producing a reverse current, was very considerable.

1042. *Weak and exhausted charges* should never be used at the same time with *strong and fresh ones* in the different cells of a trough, or the different troughs of a battery: the fluid in all the cells should be alike, else the plates in the weaker cells, in place of assisting, retard the passage of the electricity generated in, and transmitted across, the stronger cells. Each zinc plate so circumstanced has to be assisted in decomposing power before the whole current can pass between it and the liquid. So, that, if in a battery of fifty pairs of plates, ten of the cells contain a weaker charge than the others, it is as if ten decomposing plates were opposed to the transit of the current of forty pairs of generating plates (1031.). Hence a serious loss of force, and hence the reason why, if the ten pairs of plates were removed, the remaining forty pairs would be much more powerful than the whole fifty.

1043. Five similar troughs, of ten pairs of plates each, were prepared, four of them with a good uniform charge of acid, and the fifth with the partially neutralized acid of a used battery. Being arranged in right order, and connected with a volta-electrometer (711.), the whole fifty pairs of plates yielded 1.1 cubic inch of oxygen and hydrogen in one minute: but on moving one of the connecting wires so that only the four well-charged troughs should be included in the circuit, they produced with the same volta-electrometer 8.4 cubical inches of gas in the same time. Nearly seven-eighths of the power of the four troughs had been lost, therefore, by their association with the fifth trough.

1044. The same battery of fifty pairs of plates, after being thus used, was connected with the volta-electrometer (711.), so that by quickly shifting the wires of communication, the current of the whole of the battery, or of any portion of it, could be made to pass through the instrument for given portions of time in succession. The whole of the battery evolved 0.9 of a

eubic inch of oxygen and hydrogen in half a minute; the forty plates evolved 4.6 eubic inches in the same time; the whole then evolved 1 eubic inch in the half minute; the ten weakly charged evolved 0.4 of a eubic inch in the time given: and finally the whole evolved 1.15 cubic inch in the standard time. The order of the observations was that given; the results sufficiently show the extremely injurious effect produced by the mixture of strong and weak charges in the same battery*.

1045. In the same manner associations of *strong and weak* pairs of plates should be carefully avoided. A pair of copper and platina plates arranged in *accordance* with a pair of zinc and platina plates in dilute sulphuric acid, were found to stop the action of the latter, or even of two pairs of the latter, as effectually almost as an interposed plate of platina (1011.), or as if the copper itself had been platina. It, in fact, became an interposed decomposing plate, and therefore a retarding instead of an assisting pair.

1046. The *reversal*, by accident or otherwise, of the plates in a battery has an exceedingly injurious effect. It is not merely the counteraction of the current which the reversed plates can produce, but their effect also in retarding even as indifferent plates, and requiring decomposition to be effected upon their surface, in *accordance* with the course of the current, before the latter can pass. They oppose the current, therefore, in the first place, as interposed platina plates would do (1011—1018.); and to this they add a force of opposition as counter-voltaic plates. I find that, in a series of four pairs of zinc and platina plates in dilute sulphuric acid, if one pair be reversed, it very nearly neutralizes the power of the whole.

1047. There are many other causes of reaction, retardation, and irregularity in the voltaic battery. Amongst them is the not unusual one of precipitation of copper upon the zinc in the cells, the injurious effect of which has before been adverted to (1006.). But their interest is not perhaps sufficient to justify any increase of the length of this paper, which is rather in-

* The gradual increase in the action of the whole fifty pairs of plates was due to the elevation of temperature in the weakly charged trough by the passage of the current, in consequence of which the exciting energies of the fluid within were increased.

tended to be an investigation of the theory of the voltaic pile than a particular account of its practical application*.

Note.—Many of the views and experiments in this Series of my Experimental Researches will be seen at once to be corrections and extensions of the theory of electro-chemical decomposition, given in the Fifth and Seventh Series of these Researches. The expressions I would now alter are those which concern the independence of the evolved elements in relation to the poles or electrodes, and the reference of their evolution to powers entirely internal (524. 537. 661.). The present paper fully shows my present views; and I would refer to paragraphs 891. 904. 910. 917. 918. 947. 963. 1007. 1031. &c., as stating what they are. I hope this note will be considered as sufficient in the way of correction at present; for I would rather defer revising the whole theory of electro-chemical decomposition until I can obtain clearer views of the way in which the power under consideration can appear at one time as associated with particles giving them their chemical attraction, and at another as free electricity (493. 957.).—M. F.

Royal Institution,

March 31st, 1834.

* For further practical results relating to these points of the philosophy of the voltaic battery, see Series X. § 17. 1136.—1160.—*Dec.* 1838.

NINTH SERIES.

§ 15. *On the influence by induction of an Electric Current on itself:—and on the inductive action of Electric Currents generally.*

Received December 18, 1834,—Read January 29, 1835.

1048. THE following investigations relate to a very remarkable inductive action of electric currents, or of the different parts of the same current (74.), and indicate an immediate connexion between such inductive action and the direct transmission of electricity through conducting bodies, or even that exhibited in the form of a spark.

1049. The inquiry arose out of a fact communicated to me by Mr. Jenkin, which is as follows. If an ordinary wire of short length be used as the medium of communication between the two plates of an electromotor consisting of a single pair of metals, no management will enable the experimenter to obtain an electric shock from this wire; but if the wire which surrounds an electro-magnet be used, a shock is felt each time the contact with the electromotor is broken, provided the ends of the wire be grasped one in each hand.

1050. Another effect is observed at the same time, which has long been known to philosophers, namely, that a bright electric spark occurs at the place of disjunction.

1051. A brief account of these results, with some of a corresponding character which I had observed in using long wires, was published in the Philosophical Magazine for 1834*; and I added to them some observations on their nature. Further investigations led me to perceive the inaccuracy of my first notions and ended in identifying these effects with the phenomena of induction which I had been fortunate enough to develop in the First Series of these Experimental Researches (1.—59.)†. Notwithstanding this identity, the extension and the peculiarity of the views respecting electric currents which

* Vol. v. pp. 349, 444.

† Philosophical Transactions, 1832, p. 126.

the results supply, lead me to believe that they will be found worthy of the attention of the Royal Society.

1052. The *electromotor* used consisted of a cylinder of zinc introduced between the two parts of a double cylinder of copper, and preserved from metallic contact in the usual way by corks. The zinc cylinder was eight inches high and four inches in diameter. Both it and the copper cylinder were supplied with stiff wires, surmounted by cups containing mercury; and it was at these cups that the contacts of wires, helices, or electro-magnets, used to complete the circuit, were made or broken. These cups I will call G and E throughout the rest of this paper (1079.).

1053. Certain *helices* were constructed, some of which it will be necessary to describe. A pasteboard tube had four copper wires, one twenty-fourth of an inch in thickness, wound round it, each forming a helix in the same direction from end to end: the convolutions of each wire were separated by string, and the superposed helices prevented from touching by intervening calico. The lengths of the wires forming the helices were 48, 49·5, 48, and 45 feet. The first and third wires were united together so as to form one consistent helix of 96 feet in length; and the second and fourth wires were similarly united to form a second helix, closely interwoven with the first, and 94·5 feet in length. These helices may be distinguished by the numbers i and ii. They were carefully examined by a powerful current of electricity and a galvanometer, and found to have no communication with each other.

1054. Another helix was constructed upon a similar pasteboard tube, two lengths of the same copper wire being used, each forty-six feet long. These were united into one consistent helix of ninety-two feet, which therefore was nearly equal in value to either of the former helices, but was not in close inductive association with them. It may be distinguished by the number iii.

1055. A fourth helix was constructed of very thick copper wire, being one fifth of an inch in diameter; the length of wire used was seventy-nine feet, independent of the straight terminal portions.

1056. The principal *electro-magnet* employed consisted of a cylindrical bar of soft iron twenty-five inches long, and one inch

and three quarters in diameter, bent into a ring, so that the ends nearly touched, and surrounded by three coils of thick copper wire, the similar ends of which were fastened together; each of these terminations was soldered to a copper rod, serving as a conducting continuation of the wire. Hence any electric current sent through the rods was divided in the helices surrounding the ring, into three parts, all of which, however, moved in the same direction. The three wires may therefore be considered as representing one wire, of three times the thickness of the wire really used.

1057. Other electro-magnets could be made at pleasure by introducing a soft iron rod into any of the helices described (1053, &c.).

1058. The *galvanometer* which I had occasion to use was rough in its construction, having but one magnetic needle, and not at all delicate in its indications.

1059. The effects to be considered *depend on the conductor* employed to complete the communication between the zinc and copper plates of the electromotor; and I shall have to consider this conductor under four different forms: as the helix of an electro-magnet (1056.); as an ordinary helix (1053. &c.); as a *long* extended wire, having its course such that the parts can exert little or no mutual influence; and as a *short* wire. In all cases the conductor was of copper.

1060. The peculiar effects are best shown by the *electro-magnet* (1056.). When it was used to complete the communication at the electromotor, there was no sensible spark on *making* contact, but on *breaking* contact there was a very large and bright spark, with considerable combustion of the mercury. Then, again, with respect to the shock: if the hands were moistened in salt and water, and good contact between them and the wires retained, no shock could be felt upon *making* contact at the electromotor, but a powerful one on *breaking* contact.

1061. When the *helix* i or iii (1053. &c.) was used as the connecting conductor, there was also a good spark on breaking contact, but none (sensibly) on making contact. On trying to obtain the shock from these helices, I could not succeed at first. By joining the similar ends of i and ii so as to make the two helices equivalent to one helix, having wire of double thickness,

I could just obtain the sensation. Using the helix of thick wire (1055.) the shock was distinctly obtained. On placing the tongue between two plates of silver connected by wires with the parts which the hands had heretofore touched (1064.), there was a powerful shock on *breaking* contact, but none on *making* contact.

1062. The power of producing these phenomena exists therefore in the simple helix, as in the electro-magnet, although by no means in the same high degree.

1063. On putting a bar of soft iron into the helix, it became an electro-magnet (1057.), and its power was instantly and greatly raised. On putting a bar of copper into the helix, no change was produced, the action being that of the helix alone. The two helices i and ii, made into one helix of twofold length of wire, produced a greater effect than either i or ii alone.

1064. On descending from the helix to the mere *long wire*, the following effects were obtained. A copper wire, 0.18 of an inch in diameter, and 132 feet in length, was laid out upon the floor of the laboratory, and used as the connecting conductor (1059.) ; it gave no sensible spark on making contact, but produced a bright one on breaking contact, yet not so bright as that from the helix (1061.). On endeavouring to obtain the electric shock at the moment contact was broken, I could not succeed so as to make it pass through the hands ; but by using two silver plates fastened by small wires to the extremity of the principal wire used, and introducing the tongue between those plates, I succeeded in obtaining powerful shocks upon the tongue and gums, and could easily convulse a flounder, an eel, or a frog. None of these effects could be obtained directly from the electromotor, *i. e.* when the tongue, frog, or fish was in a similar, and therefore comparative manner, interposed in the course of the communication between the zinc and copper plates, separated everywhere else by the acid used to excite the combination, or by air. The bright spark and the shock, produced only on breaking contact, are therefore effects of the same kind as those produced in a higher degree by the helix, and in a still higher degree by the electro-magnet.

1065. In order to compare an extended wire with a helix, the helix i, containing ninety-six feet, and ninety-six feet of the same-sized wire lying on the floor of the laboratory, were used

alternately as conductors: the former gave a much brighter spark at the moment of disjunction than the latter. Again, twenty-eight feet of copper wire were made up into a helix, and being used gave a good spark on disjunction at the electromotor; being then suddenly pulled out and again employed, it gave a much smaller spark than before, although nothing but its spiral arrangement had been changed.

1066. As the superiority of a helix over a wire is important to the philosophy of the effect, I took particular pains to ascertain the fact with certainty. A wire of copper sixty-seven feet long was bent in the middle so as to form a double termination which could be communicated with the electromotor; one of the halves of this wire was made into a helix and the other remained in its extended condition. When these were used alternately as the connecting wire, the helix half gave by much the strongest spark. It even gave a stronger spark than when it and the extended wire were used conjointly as a double conductor.

1067. When a *short wire* is used, *all* these effects disappear. If it be only two or three inches long, a spark can scarcely be perceived on breaking the junction. If it be ten or twelve inches long and moderately thick, a small spark may be more easily obtained. As the length is increased, the spark becomes proportionately brighter, until from extreme length the resistance offered by the metal as a conductor begins to interfere with the principal result.

1068. The effect of elongation was well shown thus: 114 feet of copper wire, one eighteenth of an inch in diameter, were extended on the floor and used as a conductor; it remained cold, but gave a bright spark on breaking contact. Being crossed so that the two terminations were in contact near the extremities, it was again used as a conductor, only twelve inches now being included in the circuit: the wire became very hot from the greater quantity of electricity passing through it, and yet the spark on breaking contact was scarcely visible. The experiment was repeated with a wire one ninth of an inch in diameter and thirty-six feet long with the same results.

1069. That the effects, and also the action, in all these forms of the experiment are identical, is evident from the manner in which the former can be gradually raised from that produced

by the shortest wire to that of the most powerful electro-magnet: and this capability of examining what will happen by the most powerful apparatus, and then experimenting for the same results, or reasoning from them, with the weaker arrangements, is of great advantage in making out the true principles of the phenomena.

1070. The action is evidently dependent upon the wire which serves as a conductor; for it varies as that wire varies in its length or arrangement. The shortest wire may be considered as exhibiting the full effect of spark or shock which the electromotor can produce by its own direct power; all the additional force which the arrangements described can excite being due to some affection of the current, either permanent or momentary, in the wire itself. That it is a *momentary* effect, produced only at the instant of breaking contact, will be fully proved (1089. 1100.).

1071. No change takes place in the quantity or intensity of the current during the time the latter is *continued*, from the moment after contact is made, up to that previous to disunion, except what depends upon the increased obstruction offered to the passage of the electricity by a long wire as compared to a short wire. To ascertain this point with regard to *quantity*, the helix i (1053.) and the galvanometer (1058.) were both made parts of the metallic circuit used to connect the plates of a small electromotor, and the deflection at the galvanometer was observed; then a soft iron core was put into the helix, and as soon as the momentary effect was over, and the needle had become stationary, it was again observed, and found to stand exactly at the same division as before. Thus the quantity passing through the wire when the current was continued was the same either with or without the soft iron, although the peculiar effects occurring at the moment of disjunction were very different in degree under such variation of circumstances.

1072. That the quality of *intensity* belonging to the constant current did not vary with the circumstances favouring the peculiar results under consideration, so as to yield an explanation of those results, was ascertained in the following manner. The current excited by an electromotor was passed through short wires, and its intensity tried by subjecting different substances to its electrolyzing power (912. 966. &c.); it was then passed

through the wires of the powerful electro-magnet (1056.), and again examined with respect to its intensity by the same means and found unchanged. Again, the constancy of the *quantity* passed in the above experiment (1071.) adds further proof that the intensity could not have varied; for had it been increased upon the introduction of the soft iron, there is every reason to believe that the quantity passed in a given time would also have increased.

1073. The fact is, that under many variations of the experiments, the permanent current *loses* in force as the effects upon breaking contact become *exalted*. This is abundantly evident in the comparative experiments with long and short wires (1068.); and is still more strikingly shown by the following variation. Solder an inch or two in length of fine platina wire (about one hundredth of an inch in diameter) on to one end of the long communicating wire, and also a similar length of the same platina wire on to one end of the short communication; then, in comparing the effects of these two communications, make and break contact between the platina terminations and the mercury of the cup G or E (1079.). When the short wire is used, the platina will be *ignited by the constant current*, because of the quantity of electricity, but the spark on breaking contact will be hardly visible; on using the longer communicating wire, which by obstructing will diminish the current, the platina will remain cold whilst the current passes, but give a bright spark at the moment it ceases: thus the strange result is obtained of a diminished spark and shock from the strong current, and increased effects from the weak one. Hence the spark and shock at the moment of disjunction, although resulting from great intensity and quantity of the current *at that moment*, are no direct indicators or measurers of the intensity or quantity of the constant current previously passing, and by which they are ultimately produced.

1074. It is highly important in using the spark as an indication, by its relative brightness, of these effects, to bear in mind certain circumstances connected with its production and appearance (958.). An ordinary electric spark is understood to be the bright appearance of electricity passing suddenly through an interval of air, or other badly conducting matter.

A voltaic spark is sometimes of the same nature, but generally, is due to the ignition and even combustion of a minute portion of a good conductor; and that is especially the case when the electromotor consists of but one or few pairs of plates. This can be very well observed if either or both of the metallic surfaces intended to touch be solid and pointed. The moment they come in contact the current passes; it heats, ignites, and even burns the touching points, and the appearance is as if the spark passed on making contact, whereas it is only a case of ignition by the current, contact being previously made, and is perfectly analogous to the ignition of a fine platina wire connecting the extremities of a voltaic battery.

1075. When mercury constitutes one or both of the surfaces used, the brightness of the spark is greatly increased. But as this effect is due to the action on, and probable combustion of, the metal, such sparks must only be compared with other sparks also taken from mercurial surfaces, and not with such as may be taken, for instance, between surfaces of platina or gold, for then the appearances are far less bright, though the same quantity of electricity be passed. It is not at all unlikely that the commonly occurring circumstance of combustion may affect even the duration of the light; and that sparks taken between mercury, copper, or other combustible bodies, will continue for a period sensibly longer than those passing between platina or gold.

1076. When the end of a short clean copper wire, attached to one plate of an electromotor, is brought down carefully upon a surface of mercury connected with the other plate, a spark, almost continuous, can be obtained. This I refer to a succession of effects of the following nature: first, contact,—then ignition of the touching points,—recession of the mercury from the mechanical results of the heat produced at the place of contact, and the electro-magnetic condition of the parts at the moment*,—breaking of the contact and the production of the peculiar intense effect dependent thereon,—renewal of the contact by the returning surface of the undulating mercury,—and then a repetition of the same series of effects, and that with such rapidity as to present the appearance of a continued dis-

* Quarterly Journal of Science, vol. xii. p. 420.

charge. If a long wire or an electro-magnet be used as the connecting conductor instead of a short wire, a similar appearance may be produced by tapping the vessel containing the mercury and making it vibrate; but the sparks do not usually follow each other so rapidly as to produce an apparently continuous spark, because of the time required, when the long wire or electro-magnet is used, both for the full development of the current (1101. 1106.) and for its complete cessation.

1077. Returning to the phenomena in question, the first thought that arises in the mind is, that the electricity circulates with something like *momentum or inertia* in the wire, and that thus a long wire produces effects at the instant the current is stopped, which a short wire cannot produce. Such an explanation is, however, at once set aside by the fact, that the same length of wire produces the effects in very different degrees, according as it is simply extended, or made into a helix, or forms the circuit of an electro-magnet (1069.). The experiments to be adduced (1089.) will still more strikingly show that the idea of momentum cannot apply.

1078. The bright spark at the electromotor, and the shock in the arms, appeared evidently to be due to *one* current in the long wire, divided into two parts by the double channel afforded through the body and through the electromotor; for that the spark was evolved at the place of disjunction with the electromotor, not by any direct action of the latter, but by a force immediately exerted in the wire of communication, seemed to be without doubt (1070.). It followed, therefore, that by using a better conductor in place of the human body, the *whole* of this extra current might be made to pass at that place; and thus be separated from that which the electromotor could produce by its immediate action, and its *direction* be examined apart from any interference of the original and originating current. This was found to be true; for on connecting the ends of the principal wire together by a cross wire two or three feet in length, applied just where the hands had felt the shock, the whole of the extra current passed by the new channel, and then no better spark than one producible by a short wire was obtained on disjunction at the electromotor.

1079. The *current* thus separated was examined by galva-

nometers and decomposing apparatus introduced into the course of this wire. I will always speak of it as the current in the cross wire or wires, so that no mistake, as to its place or origin, may occur. In the wood-cut, Z and C represent the zinc and copper plates of the electromotor; G and E the cups of mercury where contact is made or broken (1052.); A and B the terminations of D, the long wire, the helix, or the electro-magnet, used to complete the circuit; N and P are the cross wires, which can either be brought into contact at x , or else have a galvanometer (1058.) or an electrolyzing apparatus (312. 316.) interposed there.

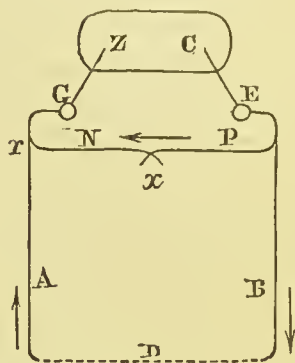

The production of the *shock* from the current in the cross wire, whether D was a long extended wire, or a helix, or an electro-magnet, has been already described (1064. 1061. 1060.).

1080. The *spark* of the cross-wire current could be produced at x in the following manner: D was made an electro-magnet; the metallic extremities at x were held close together, or rubbed lightly against each other, whilst contact was broken at G or E. When the communication was perfect at x , little or no spark appeared at G or E. When the condition of vicinity at x was favourable for the result required, a bright spark would pass there at the moment of disjunction, *none* occurring at G and E: this spark was the luminous passage of the extra current through the cross-wires. When there was no contact or passage of current at x , then the spark appeared at G or E, the extra current forcing its way through the electromotor itself. The same results were obtained by the use of the helix or the extended wire at D in place of the electro-magnet.

1081. On introducing a fine platina wire at x , and employing the electro-magnet at D, no visible effects occurred as long as contact was continued; but on breaking contact at G or E, the fine wire was instantly ignited and fused. A longer or thicker wire could be so adjusted at x as to show ignition, without fusion, every time the contact was broken at G or E.

1082. It is rather difficult to obtain this effect with helices or wires, and for very simple reasons: with the helices i, ii, or iii, there was such retardation of the electric current, from the

length of wire used, that a full inch of platina wire one fiftieth of an inch in diameter could be retained ignited at the cross-wires during the *continuance of contact*, by the portion of electricity passing through it. Hence it was impossible to distinguish the particular effects at the moments of making or breaking contact from this constant effect. On using the thick wire helix (1055.), the same results ensued.

1083. Proceeding upon the known fact that electric currents of great quantity but low intensity, though able to ignite thick wires, cannot produce that effect upon thin ones, I used a very fine platina wire at x , reducing its diameter until a spark appeared at G or E, when contact was broken there. A quarter of an inch of such wire might be introduced at x without being ignited by the *continuance* of contact at G or E; but when contact was broken at either place, this wire became red hot; proving, by this method, the production of the induced current at that moment.

1084. *Chemical decomposition* was next effected by the cross-wire current, an electro-magnet being used at D, and a decomposing apparatus, with solution of iodide of potassium in paper (1079.), employed at x . The conducting power of the connecting system A B D was sufficient to carry all the primary current, and consequently no chemical action took place at x during the *continuance* of contact at G and E; but when contact was broken, there was instantly decomposition at x . The iodine appeared against the wire N, and not against the wire P; thus demonstrating that the current through the cross-wires, when contact was broken, was in the *reverse direction* to that marked by the arrow, or that which the electromotor would have sent through it.

1085. In this experiment a bright spark occurs at the place of disjunction, indicating that only a small part of the extra current passed the apparatus at x , because of the small conducting power of the latter.

1086. I found it difficult to obtain the chemical effects with the simple helices and wires, in consequence of the diminished inductive power of these arrangements, and because of the passage of a strong constant current at x whenever a very active electromotor was used (1082.).

1087. The most instructive set of results was obtained, how-

ever, when the *galvanometer* was introduced at *x*. Using an electro-magnet at D, and continuing contact, a current was then indicated by the deflection, proceeding from P to N, in the direction of the arrow; the cross-wire serving to carry one part of the electricity excited by the electromotor, and that part of the arrangement marked A B D, the other and far greater part, as indicated by the arrows. The magnetic needle was then forced back, by pins applied upon opposite sides of its two extremities, to its natural position when uninfluenced by a current; after which, contact being *broken* at G or E, it was deflected strongly in the opposite direction; thus showing, in accordance with the chemical effects (1084.), that the extra current followed a course in the cross-wires *contrary* to that indicated by the arrow, *i. e.* contrary to the one produced by the direct action of the electromotor*.

1088. With the *helix* only (1061.), these effects could scarcely be observed, in consequence of the smaller inductive force of this arrangement, the opposed action from induction in the galvanometer wire itself, the mechanical condition and tension of the needle from the effect of blocking (1087.) whilst the current due to continuance of contact was passing round it; and because of other causes. With the *extended wire* (1064.) all these circumstances had still greater influence, and therefore allowed less chance of success.

1089. These experiments, establishing as they did, by the quantity, intensity, and even direction, a distinction between the primary or generating current and the extra current, led me to conclude that the latter was identical with the induced current described (6. 26. 74.) in the First Series of these Researches; and this opinion I was soon able to bring to proof, and at the same times obtained not the partial (1078.) but entire separation of one current from the other.

1090. The double helix (1053.) was arranged so that it should form the connecting wire between the plates of the electromotor, ii being out of the current, and its ends unconnected. In this condition i acted very well, and gave a good spark at the time

* It was ascertained experimentally, that if a strong current was passed through the galvanometer only, and the needle restrained in one direction as above in its natural position, when the current was stopped, no vibration of the needle in the opposite direction took place.

and place of disjunction. The opposite ends of *ii* were then connected together so as to form an endless wire, *i* remaining unchanged; but now *no spark*, or one scarcely sensible, could be obtained from the latter at the place of disjunction. Then, again, the ends of *ii* were held so nearly together that any current running round that helix should be rendered visible as a spark; and in this manner a spark was obtained from *ii* when the junction of *i* with the electromotor was broken, in place of appearing at the disjointed extremity of *i* itself.

1091. By introducing a galvanometer or a decomposing apparatus into the circuit formed by the helix *ii*, I could easily obtain the deflections and decomposition occasioned by the induced current due to the breaking contact at helix *i*, or even to that occasioned by making contact of that helix with the electromotor; the results in both cases indicating the contrary directions of the two induced currents thus produced (26.).

1092. All these effects, except those of decomposition, were reproduced by two extended long wires, not having the form of helices, but placed close to each other; and thus it was proved that the *extra current* could be removed from the wire carrying the original current to a neighbouring wire, and was at the same time identified, in direction and every other respect, with the currents producible by induction (1089.). The case, therefore, of the bright spark and shock on disjunction may now be stated thus: If a current be established in a wire, and another wire, forming a complete circuit, be placed parallel to the first, at the moment the current in the first is stopped it induces a current in the *same* direction in the second, the first exhibiting then but a feeble spark; but if the second wire be away, disjunction of the first wire induces a current in itself in the same direction, producing a strong spark. The strong spark in the single long wire or helix, at the moment of disjunction, is therefore the equivalent of the current which would be produced in a neighbouring wire if such second current were permitted.

1093. Viewing the phenomena as the results of the induction of electrical currents, many of the principles of action, in the former experiments, become far more evident and precise. Thus the different effects of short wires, long wires, helices, and electro-magnets (1069.) may be comprehended. If the inductive action of a wire a foot long upon a collateral wire also a foot in

length, be observed, it will be found very small; but if the same current be sent through a wire fifty feet long, it will induce in a neighbouring wire of fifty feet a far more powerful current at the moment of making or breaking contact, each successive foot of wire adding to the sum of action; and by parity of reasoning, a similar effect should take place when the conducting wire is also that in which the induced current is formed (74.): hence the reason why a long wire gives a brighter spark on breaking contact than a short one (1068.), although it carries much less electricity.

1094. If the long wire be made into a helix, it will then be still more effective in producing sparks and shocks on breaking contact; for by the mutual inductive action of the convolutions each aids its neighbour, and will be aided in turn, and the sum of effect will be very greatly increased.

1095. If an electro-magnet be employed, the effect will be still more highly exalted; because the iron, magnetized by the power of the continuing current, will lose its magnetism at the moment the current ceases to pass, and in so doing will tend to produce an electric current in the wire around it (37. 38.), in conformity with that which the cessation of current in the helix itself also tends to produce.

1096. By applying the laws of the induction of electric currents formerly developed (6. &c.), various new conditions of the experiments could be devised, which by their results should serve as tests of the accuracy of the view just given. Thus, if a long wire be doubled, so that the current in the two halves shall have opposite actions, it ought not to give a sensible spark at the moment of disjunction: and this proved to be the case, for a wire forty feet long, covered with silk, being doubled and tied closely together to within four inches of the extremities, when used in that state, gave scarcely a perceptible spark; but being opened out and the parts separated, it gave a very good one. The two helices i and ii being joined at their similar ends, and then used at their other extremities to connect the plates of the electromotor, thus constituted one long helix, of which one half was opposed in direction to the other half: under these circumstances it gave scarcely a sensible spark, even when the soft iron core was within, although containing nearly two hundred

feet of wire. When it was made into one consistent helix of the same length of wire it gave a very bright spark.

1097. Similar proofs can be drawn from the mutual inductive action of two separate currents (1110.); and it is important for the general principles that the consistent action of two such currents should be established. Thus, two currents going in the same direction should, if simultaneously stopped, aid each other by their relative influence; or if proceeding in contrary directions should oppose each other under similar circumstances. I endeavoured at first to obtain two currents from two different electromotors, and passing them through the helices i and ii, tried to effect the disjunctions mechanically at the same moment. But in this I could not succeed; one was always separated before the other, and in that case produced little or no spark, its inductive power being employed in throwing a current round the remaining complete circuit (1090.): the current which was stopped last always gave a bright spark. If it were ever to become needful to ascertain whether two junctions were accurately broken at the same moment, these sparks would afford a test for the purpose, having an infinitesimal degree of perfection.

1098. I was able to prove the points by other expedients. Two short thick wires were selected to serve as terminations, by which contact could be made or broken with the electromotor. The compound helix, consisting of i and ii (1053.), was adjusted so that the extremities of the two helices could be placed in communication with the two terminal wires, in such a manner that the current moving through the thick wires should be divided into two equal portions in the two helices, these portions travelling, according to the mode of connexion, either in the same direction or in contrary directions at pleasure. In this manner two streams could be obtained, both of which could be stopped simultaneously, because the disjunction could be broken at G or F by removing a single wire. When the helices were in contrary directions, there was scarcely a sensible spark at the place of disjunction; but when they were in accordance there was a very bright one.

1099. The helix i was now used constantly, being sometimes associated, as above, with helix ii in an according direction, and sometimes with helix iii, which was placed at a little di-

stance. The association i and ii, which presented two currents able to affect each other by induction, because of their vicinity, gave a brighter spark than the association i and iii, where the two streams could not exert their mutual influence; but the difference was not so great as I expected.

1100. Thus all the phenomena tend to prove that the effects are due to an inductive action, occurring at the moment when the principal current is stopped. I at one time thought they were due to an action continued during the *whole time* of the current, and expected that a steel magnet would have an influence according to its position in the helix, comparable to that of a soft iron bar, in assisting the effect. This, however, is not the case; for hard steel, or a magnet in the helix, is not so effectual as soft iron; nor does it make any difference how the magnet is placed in the helix, and for very simple reasons, namely, that the effect does not depend upon a permanent state of the core, but a *change of state*; and that the magnet or hard steel cannot sink through such a difference of state as soft iron, at the moment contact ceases, and therefore cannot produce an equal effect in generating a current of electricity by induction (34. 37.).

1101. As an electric current acts by induction with equal energy at the moment of its commencement as at the moment of its cessation (10. 26.), but in a contrary direction, the reference of the effects under examination to an inductive action, would lead to the conclusion that corresponding effects of an opposite nature must occur in a long wire, a helix, or an electro-magnet, every time that *contact is made* with the electromotor. These effects will tend to establish a resistance for the first moment in the long conductor, producing a result equivalent to the reverse of a shock or a spark. Now it is very difficult to devise means fit for the recognition of such negative results; but as it is probable that some positive effect is produced at the time, if we knew what to expect, I think the few facts bearing upon this subject with which I am acquainted are worth recording.

1102. The electro-magnet was arranged with an electrolyzing apparatus at *x*, as before described (1084.), except that the intensity of the chemical action at the electromotor was increased until the electric current was just able to produce the

feeblest signs of decomposition whilst contact was continued at G and E (1079.) ; (the iodine of course appearing against the end of the cross wire P;) the wire N was also separated from A at *r*, so that contact there could be made or broken at pleasure. Under these circumstances the following set of actions was repeated several times: contact was broken at *r*, then broken at G, next made at *r*, and lastly renewed at G; thus any current from N to P due to *breaking* of contact was avoided, but any additional force to the current from P to N due to *making* contact could be observed. In this way it was found, that a much greater decomposing effect (causing the evolution of iodine against P) could be obtained by a few completions of contact than by the current which could pass in a much longer time if the contact was *continued*. This I attribute to the act of induction in the wire A B D at the moment of contact rendering that wire a worse conductor, or rather retarding the passage of the electricity through it for the instant, and so throwing a greater quantity of the electricity which the electromotor could produce, through the cross wire passage N P. The instant the induction ceased, A B D resumed its full power of carrying a constant current of electricity, and could have it highly increased, as we know by the former experiments (1060.) by the opposite inductive action brought into activity at the moment contact at Z or C was *broken*.

1103. A galvanometer was then introduced at *x*, and the deflection of the needle noted whilst contact was continued at G and E; the needle was then blocked as before in one direction (1087.), so that it should not return when the current ceased, but remain in the position in which the current could retain it. Contact at G or E was broken, producing of course no visible effect; it was then renewed, and the needle was instantly deflected, passing from the blocking pins to a position still further from its natural place than that which the constant current could give, and thus showing, by the temporary excess of current in this cross communication, the temporary retardation in the circuit A B D.

1104. On adjusting a platina wire at *x* (1081.) so that it should not be ignited by the current passing through it whilst contact at G and E was *continued*, and yet become red hot by a current somewhat more powerful, I was readily able to pro-

duce its ignition upon *making contact*, and again upon *breaking contact*. Thus the momentary retardation in A B D on making contact was again shown by this result, as well also as the opposite result upon breaking contact. The two ignitions of the wire at *x* were of course produced by electric currents moving in opposite directions.

1105. Using the *helix* only, I could not obtain distinct deflections at *x*, due to the extra effect on making contact, for the reasons already mentioned (1088.). By using a very fine platina wire there (1083.), I did succeed in obtaining the igniting effect for making contact in the same manner, though by no means to the same degree, as with the electro-magnet (1104.).

1106. We may also consider and estimate the effect on *making contact*, by transferring the force of induction from the wire carrying the original current to a lateral wire, as in the cases described (1090.); and we then are sure, both by the chemical and galvanometrical results (1091.), that the forces upon making and breaking contact, like action and reaction, are equal in their strength but contrary in their direction. If, therefore, the effect on making contact resolves itself into a mere retardation of the current at the first moment of its existence, it must be, in its degree, equivalent to the high exaltation of that same current at the moment contact is broken.

1107. Thus the case, under the circumstances, is, that the intensity and quantity of electricity moving in a current are smaller when the current commences or is increased, and greater when it diminishes or ceases, than they would be if the inductive action occurring at these moments did not take place; or than they are in the original current wire if the inductive action be transferred from that wire to a collateral one (1090.).

1108. From the facility of transference to neighbouring wires, and from the effects generally, the inductive forces appear to be lateral, *i. e.* exerted in a direction perpendicular to the direction of the originating and produced currents; and they also appear to be accurately represented by the magnetic curves, and closely related to, if not identical with, magnetic forces.

1109. There can be no doubt that the current in one part of a wire can act by induction upon other parts of the *same* wire which are lateral to the first, *i. e.* in the same vertical section (74.), or in parts which are more or less oblique to it

(1112.), just as it can act in producing a current in a neighbouring wire or in a neighbouring coil of the same wire. It is this which gives the appearance of the current acting upon itself; but all the experiments and all analogy tend to show that the elements (if I may so say) of the currents do not act upon themselves, and so cause the effect in question, but produce it by exciting currents in conducting matter which is lateral to them.

1110. It is possible that some of the expressions I have used may seem to imply, that the inductive action is essentially the action of one current upon another, or of one element of a current upon another element of the same current. To avoid any such conclusion I must explain more distinctly my meaning. If an endless wire be taken, we have the means of generating a current in it which shall run round the circuit without adding any electricity to what was previously in the wire. As far as we can judge, the electricity which appears as a current is the same as that which before was quiescent in the wire; and though we cannot as yet point out the essential condition of difference of the electricity at such times, we can easily recognise the two states. Now when a current acts by induction upon conducting matter lateral to it, it probably acts upon the electricity in that conducting matter whether it be in the form of a *current* or *quiescent*, in the one case increasing or diminishing the current according to its direction, in the other producing a current, and the *amount* of the inductive action is probably the same in both cases. Hence, to say that the action of induction depended upon the mutual relation of two or more currents, would, according to the restricted sense in which the term current is understood at present (283. 517. 667.), be an error.

1111. Several of the effects, as, for instances, those with helices (1066.), with ascending or counter currents (1097. 1098.), and those on the production of lateral currents (1090.), appeared to indicate that a current could produce an effect of induction in a neighbouring wire more readily than in its own carrying wire, in which case it might be expected that some variation of result would be produced if a bundle of wires were used as a conductor instead of a single wire. In consequence the following experiments were made. A copper wire one twenty-third of an inch in diameter was cut into lengths of five

feet each, and six of these being laid side by side in one bundle, had their opposite extremities soldered to two terminal pieces of copper. This arrangement could be used as a discharging wire, but the general current could be divided into six parallel streams, which might be brought close together, or, by the separation of the wires, be taken more or less out of each other's influence. A somewhat brighter spark was, I think, obtained on breaking contact when the six wires were close together than when held asunder.

1112. Another bundle, containing twenty of these wires, was eighteen feet long; the terminal pieces were one-fifth of an inch in diameter, and each six inches long. This was compared with nineteen feet in length of copper wire one-fifth of an inch in diameter. The bundle gave a smaller spark on breaking contact than the latter, even when its strands were held together by string; when they were separated, it gave a still smaller spark. Upon the whole, however, the diminution of effect was not such as I expected; and I doubt whether the results can be considered as any proof of the truth of the supposition which gave rise to them.

1113. The inductive force by which two elements of one current (1109. 1110.) act upon each other, appears to diminish as the line joining them becomes oblique to the direction of the current, and to vanish entirely when it is parallel. I am led by some results to suspect that it then even passes into the repulsive force noticed by Ampère*; which is the cause of the elevations in mercury described by Sir Humphry Davy†, and which again is probably directly connected with the quality of intensity.

1114. Notwithstanding that the effects appear only at the making and breaking of contact, (the current remaining unaffected, seemingly, in the interval,) I cannot resist the impression that there is some connected and correspondent effect produced by this lateral action of the elements of the electric stream during the time of its continuance (60. 242.). An action of this kind, in fact, is evident in the magnetic relations of the parts of the current. But admitting (as we may do for the moment) the magnetic forces to constitute the power which produces such striking and different results at the commencement and termi-

* Recueil d'Observations Electro-Dynamiques, p. 285.

† Philosophical Transactions, 1823, p. 155.

nation of a current, still there appears to be a link in the chain of effects, a wheel in the physical mechanism of the action, as yet unrecognised. If we endeavour to consider electricity and magnetism as the results of two forces of a physical agent, or a peculiar condition of matter, exerted in determinate directions perpendicular to each other, then, it appears to me, that we must consider these two states or forces as convertible into each other in a greater or smaller degree ; *i. e.* that an element of an electric current has not a determinate electric force and a determinate magnetic force constantly existing in the same ratio, but that the two forces are, to a certain degree, convertible by a process or change of condition at present unknown to us. How else can a current of a given intensity and quantity be able, by its direct action, to sustain a state which, when allowed to react, (at the cessation of the original current,) shall produce a second current, having an intensity and quantity far greater than the generating one? This cannot result from a direct reaction of the electric force ; and if it result from a change of electrical into magnetic force, and a reconversion back again, it will show that they differ in something more than mere direction, as regards *that agent* in the conducting wire which constitutes their immediate cause.

1115. With reference to the appearance, at different times, of the contrary effects produced by the making and breaking contact, and their separation by an intermediate and indifferent state, this separation is probably more apparent than real. If the conduction of electricity be effected by vibrations (283.), or by any other mode in which opposite forces are successively and rapidly excited and neutralized, then we might expect a peculiar and contrary development of force at the commencement and termination of the periods during which the conducting action should last (somewhat in analogy with the colours produced at the outside of an imperfectly developed solar spectrum) : and the intermediate actions, although not sensible in the same way, may be very important and, for instance, perhaps constitute the very essence of conductivity. It is by views and reasons such as these, which seem to me connected with the fundamental laws and facts of electrical science, that I have been induced to enter, more minutely than I otherwise should have done, into the experimental examination of the phenomena described in this paper.

1116. Before concluding, I may briefly remark, that on using a voltaic battery of fifty pairs of plates instead of a single pair (1052.), the effects were exactly of the same kind. The spark on making contact, for the reasons before given, was very small (1101. 1107.); that on breaking contact, very excellent and brilliant. The *continuous* discharge did not seem altered in character, whether a short wire or the powerful electro-magnet were used as a connecting discharger.

1117. The effects produced at the commencement and end of a current, (which are separated by an interval of time when that current is supplied from a voltaic apparatus,) must occur at the same moment when a common electric discharge is passed through a long wire. Whether, if happening accurately at the same moment, they would entirely neutralize each other, or whether they would not still give some definite peculiarity to the discharge, is a matter remaining to be examined; but it is very probable that the peculiar character and pungency of sparks drawn from a long wire depend in part upon the increased intensity given at the termination of the discharge by the inductive action then occurring.

1118. In the wire of the helix of magneto-electric machines, (as, for instance, in Mr. Saxton's beautiful arrangement,) an important influence of these principles of action is evidently shown. From the construction of the apparatus the current is permitted to move in a complete metallic circuit of great length during the first instants of its formation: it gradually rises in strength, and is then suddenly stopped by the breaking of the metallic circuit; and thus great intensity is given *by induction* to the electricity, which at that moment passes (1064. 1060.). This intensity is not only shown by the brilliancy of the spark and the strength of the shock, but also by the necessity which has been experienced of well insulating the convolutions of the helix, in which the current is formed; and it gives to the current a force at these moments very far above that which the apparatus could produce if the principle which forms the subject of this paper were not called into play.

Royal Institution,
December 8th, 1834.

TENTH SERIES.

§ 16. *On an improved form of the Voltaic Battery.* § 17. *Some practical results respecting the construction and use of the Voltaic Battery.*

Received June 16,—Read June 18, 1835.

1119. I HAVE lately had occasion to examine the voltaic trough practically, with a view to improvements in its construction and use; and though I do not pretend that the results have anything like the importance which attaches to the discovery of a new law or principle, I still think they are valuable, and may therefore, if briefly told, and in connexion with former papers, be worthy the approbation of the Royal Society.

§ 16. *On an improved form of the Voltaic Battery.*

1120. In a simple voltaic circuit (and the same is true of the battery) the chemical forces which, during their activity, give power to the instrument, are generally divided into two portions; one of these is exerted locally, whilst the other is transferred round the circle (947. 996.); the latter constitutes the electric current of the instrument, whilst the former is altogether lost or wasted. The ratio of these two portions of power may be varied to a great extent by the influence of circumstances: thus, in a battery not closed, *all* the action is local; in one of the ordinary construction, *much* is in circulation when the extremities are in communication; and in the perfect one, which I have described (1010), *all* the chemical power circulates and becomes electricity. By referring to the quantity of zinc dissolved from the plates (865. 1126.), and the quantity of decomposition effected in the volta-electrometer (711. 1126.) or elsewhere, the proportions of the local and transferred actions under any particular circumstances can be ascertained, and the efficacy of the voltaic arrangement, or the waste of chemical power at its zinc plates, be accurately determined.

1121. If a voltaic battery were constructed of zinc and pla-

tina, the latter metal surrounding the former, as in the double copper arrangement, and the whole being excited by dilute sulphuric acid, then no insulating divisions of glass, porcelain, or air would be required between the contiguous platina surfaces; and, provided these did not touch metallically, the same acid which, being between the zinc and platina, would excite the battery into powerful action, would, between the two surfaces of platina, produce no discharge of the electricity, nor cause any diminution of the power of the trough. This is a necessary consequence of the resistance to the passage of the current which I have shown occurs at the place of decomposition (1007. 1011.); for that resistance is fully able to stop the current, and therefore acts as insulation to the electricity of the contiguous plates, inasmuch as the current which tends to pass between them never has a higher intensity than that due to the action of a single pair.

1122. If the metal surrounding the zinc be copper (1045.), and if the acid be nitro-sulphuric acid (1020.), then a slight discharge between the two contiguous coppers does take place, provided there be no other channel open by which the forces may circulate; but when such a channel is permitted, the return or back discharge of which I speak is exceedingly diminished, in accordance with the principles laid down in the Eighth Series of these Researches.

1123. Guided by these principles I was led to the construction of a voltaic trough, in which the coppers, passing round both surfaces of the zincs, as in Wollaston's construction, should not be separated from each other except by an intervening thickness of paper, or in some other way, so as to prevent metallic contact, and should thus constitute an instrument compact, powerful, economical, and easy of use. On examining, however, what had been done before, I found that the new trough was in all essential respects the same as that invented and described by Dr. Hare, Professor in the University of Pennsylvania, to whom I have great pleasure in referring it.

1124. Dr. Hare has fully described his trough*. In it the

* Philosophical Magazine, 1824, vol. lxiii. p. 241; or Silliman's Journal, vol. vii. See also a previous paper by Dr. Hare, *Annals of Philosophy*, 1821, vol. i. p. 329, in which he speaks of the non-necessity of insulation between the coppers.

contiguous copper plates are separated by thin veneers of wood, and the acid is poured on to, or off, the plates by a quarter revolution of an axis, to which both the trough containing the plates, and another trough to collect and hold the liquid, are fixed. This arrangement I have found the most convenient of any, and have therefore adopted it. My zine plates were cut from rolled metal, and when soldered to the copper plates had the form delineated, fig. 1. These were then bent over a gauge

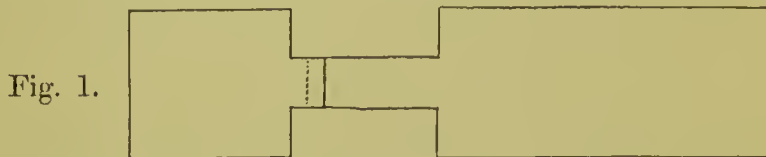

into the form fig. 2, and when packed in the wooden box constructed to receive them, were arranged as in fig. 3*, little plugs

Fig. 2.

Fig. 3.

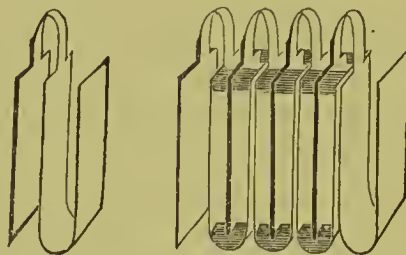

of cork being used to keep the zine plates from touching the copper plates, and a single or double thickness of cartridge paper being interposed between the contiguous surfaces of copper to prevent them from coming in contact. Such was the facility afforded by this arrangement, that a trough of forty pairs of plates could be unpacked in five minutes, and repacked again in half an hour; and the whole series was not more than fifteen inches in length.

1125. This trough, of forty pairs of plates three inches square, was compared, as to the ignition of a platina wire, the discharge between points of chareoal, the shock on the human frame, &c., with forty pairs of four-inch plates having double coppers, and used in porcelain troughs divided into insulating cells, the strength of the acid employed to excite both being the same. In all these effects the former appeared quite equal to the latter.

* The papers between the coppers are, for the sake of distinctness, omitted in the figure.

On comparing a second trough of the new construction, containing twenty pairs of four-inch plates, with twenty pairs of four-inch plates in porcelain troughs, excited by acid of the same strength, the new trough appeared to surpass the old one in producing these effects, especially in the ignition of wire.

1126. In these experiments the new trough diminished in its energy much more rapidly than the one on the old construction, and this was a necessary consequence of the smaller quantity of acid used to excite it, which in the case of the forty pairs of new construction was only one-seventh part of that used for the forty pairs in the porcelain troughs. To compare, therefore, both forms of the voltaic trough in their decomposing powers, and to obtain accurate data as to their relative values, experiments of the following kind were made. The troughs were charged with a known quantity of acid of a known strength; the electric current was passed through a volta-electrometer (711.) having electrodes 4 inches long and 2.3 inches in width, so as to oppose as little obstruction as possible to the current; the gases evolved were collected and measured, and gave the quantity of water decomposed. Then the whole of the charge used was mixed together, and a known part of it analysed, by being precipitated and boiled with excess of carbonate of soda, and the precipitate well washed, dried, ignited, and weighed. In this way the quantity of metal oxidized and dissolved by the acid was ascertained; and the part removed from each zinc plate, or from all the plates, could be estimated and compared with the water decomposed in the volta-electrometer. To bring these to one standard of comparison, I have reduced the results so as to express the loss at the plates in equivalents of zinc for the equivalent of water decomposed at the volta-electrometer: I have taken the equivalent number of water as 9, and of zinc as 32.5, and have considered 100 cubic inches of the mixed oxygen and hydrogen, as they were collected over a pneumatic trough, to result from the decomposition of 12.68 grains of water.

1127. The acids used in these experiments were three,—sulphuric, nitric, and muriatic. The sulphuric acid was strong oil of vitriol; one cubic inch of it was equivalent to 486 grains of marble. The nitric acid was very nearly pure; one cubic inch dissolved 150 grains of marble. The muriatic acid was

also nearly pure, and one cubical inch dissolved 108 grains of marble. These were always mixed with water by volumes, the standard of volume being a cubical inch.

1128. An acid was prepared consisting of 200 parts water, $4\frac{1}{2}$ parts sulphuric acid, and 4 parts nitric acid; and with this both my trough containing forty pairs of three-inch plates, and four porcelain troughs, arranged in succession, each containing ten pairs of plates with double coppers four inches square, were charged. These two batteries were then used in succession, and the action of each was allowed to continue for twenty or thirty minutes, until the charge was nearly exhausted, the connexion with the volta-electrometer being carefully preserved during the whole time, and the acid in the troughs occasionally mixed together. In this way the former trough acted so well, that for each equivalent of water decomposed in the volta-electrometer only from 2 to 2.5 equivalents of zinc were dissolved from each plate. In four experiments the average was 2.21 equivalents for each plate, or 88.4 for the whole battery. In the experiments with the porcelain troughs, the equivalents of consumption at each plate were 3.54, or 141.6 for the whole battery. In a perfect voltaic battery of forty pairs of plates (991. 1001.) the consumption would have been one equivalent for each zinc plate, or forty for the whole.

1129. Similar experiments were made with two voltaic batteries, one containing twenty pairs of four-inch plates, arranged as I have described (1124.), and the other twenty pairs of four-inch plates in porcelain troughs. The average of five experiments with the former was a consumption of 3.7 equivalents of zinc from each plate, or 74 from the whole; the average of three experiments with the latter was 5.5 equivalents from each plate, or 110 from the whole: to obtain this conclusion, two experiments were struck out, which were much against the porcelain troughs, and in which some unknown deteriorating influence was supposed to be accidentally active. In all the experiments, care was taken not to compare *new* and *old* plates together, as that would have introduced serious errors into the conclusions (1146.).

1130. When ten pairs of the new arrangement were used, the consumption of zinc at each plate was 6.76 equivalents, or 67.6 for the whole. With ten pairs of the common construction,

in a porcelain trough, the zinc oxidized was, upon an average, 15.5 equivalents each plate, or 155 for the entire trough.

1131. No doubt, therefore, can remain of the equality or even the great superiority of this form of voltaic battery over the best previously in use, namely, that with double coppers, in which the cells are insulated. The insulation of the coppers may therefore be dispensed with; and it is that circumstance which principally permits of such other alterations in the construction of the trough as gives it its practical advantages.

1132. The advantages of this form of trough are very numerous and great. i. It is exceedingly compact, for 100 pairs of plates need not occupy a trough of more than three feet in length. ii. By Dr. Hare's plan of making the trough turn upon copper pivots which rest upon copper bearings, the latter afford *fixed* terminations; and these I have found it very convenient to connect with two cups of mercury, fastened in the front of the stand of the instrument. These fixed terminations give the great advantage of arranging an apparatus to be used in connexion with the battery *before* the latter is put into action. iii. The trough is put into readiness for use in an instant, a single jug of dilute acid being sufficient for the charge of 100 pairs of four-inch plates. iv. On making the trough pass through a quarter of a revolution, it becomes active, and the great advantage is obtained of procuring for the experiment the effect of the *first contact* of the zinc and acid, which is twice or sometimes even thrice that which the battery can produce a minute or two after (1036. 1150.). v. When the experiment is completed, the acid can be at once poured from between the plates, so that the battery is never left to waste during an unconnected state of its extremities; the acid is not unnecessarily exhausted; the zinc is not uselessly consumed; and, besides avoiding these evils, the charge is mixed and rendered uniform, which produces a great and good result (1039.); and, upon proceeding to a second experiment, the important effect of *first contact* is again obtained. vi. The saving of zinc is very great. It is not merely that, whilst in action, the zinc performs more voltaic duty (1128. 1129.), but *all* the destruction which takes place with the ordinary forms of battery between the experiments is prevented. This saving is of such extent, that I estimate the zinc in the new form of battery to

be thrice as effective as that in the ordinary form. vii. The importance of this saving of metal is not merely that the value of the zinc is saved, but that the battery is much lighter and more manageable; and also that the surfaces of the zinc and copper plates may be brought much nearer to each other when the battery is constructed, and remain so until it is worn out: the latter is a very important advantage (1148.). viii. Again, as, in consequence of the saving, thinner plates will perform the duty of thick ones, rolled zinc may be used; and I have found rolled zinc superior to cast zinc in action; a superiority which I incline to attribute to its greater purity (1144.). ix. Another advantage is obtained in the economy of the acid used, which is proportionate to the diminution of the zinc dissolved. x. The acid also is more easily exhausted, and is in such small quantity that there is never any occasion to return an old charge into use. The acid of old charges whilst out of use, often dissolves portions of copper from the black flocculi usually mingled with it, which are derived from the zinc; now any portion of copper in solution in the charge does great harm, because, by the *local* action of the acid and zinc, it tends to precipitate upon the latter, and diminish its voltaic efficacy (1145.). xi. By using a due mixture of nitric and sulphuric acid for the charge (1139.), no gas is evolved from the troughs; so that a battery of several hundred pairs of plates may, without inconvenience, be close to the experimenter. xii. If, during a series of experiments, the acid becomes exhausted, it can be withdrawn, and replaced by other acid with the utmost facility; and after the experiments are concluded, the great advantage of easily washing the plates is at command. And it appears to me, that in place of making, under different circumstances, mutual sacrifices of comfort, power, and economy, to obtain a desired end, all are at once obtained by Dr. Hare's form of trough.

1133. But there are some disadvantages which I have not yet had time to overcome, though I trust they will finally be conquered. One is the extreme difficulty of making a wooden trough constantly water-tight under the alternations of wet and dry to which the voltaic instrument is subject. To remedy this evil, Mr. Newman is now engaged in obtaining porcelain troughs. The other disadvantage is a precipitation of copper

on the zinc plates. It appears to me to depend mainly on the circumstance that the papers between the coppers retain acid when the trough is emptied; and that this acid slowly acting on the copper, forms a salt, which gradually mingles with the next charge, and is reduced on the zinc plate by the local action (1120.): the power of the whole battery is then reduced. I expect that by using slips of glass or wood to separate the coppers at their edges, their contact can be sufficiently prevented, and the space between them be left so open that the acid of a charge can be poured and washed out, and so be removed from *every part* of the trough when the experiments in which the latter is used are completed.

1134. The actual superiority of the troughs which I have constructed on this plan, I believe to depend, first and principally, on the closer approximation of the zinc and copper surfaces;—in my troughs they are only one-tenth of an inch apart (1148.);—and, next, on the superior quality of the rolled zinc above the cast zinc used in the construction of the ordinary pile. It cannot be that insulation between the contiguous coppers is a disadvantage, but I do not find that it is any advantage; for when, with both the forty pairs of three-inch plates and the twenty pairs of four-inch plates, I used papers well soaked in wax*, these being so large that when folded at the edges they wrapped over each other, so as to make cells as insulating as those of the porcelain troughs, still no sensible advantage in the chemical action was obtained.

1135. As, upon principle, there must be a discharge of part of the electricity from the edges of the zinc and copper plates at the sides of the trough, I should prefer, and intend having, troughs constructed with a plate or plates of crown glass at the sides of the trough: the bottom will need none, though to glaze that and the ends would be no disadvantage. The plates need not be fastened in, but only set in their places; nor need they be in large single pieces.

§ 17. *Some practical results respecting the construction and use of the Voltaic Battery* (1034. &c.).

1136. The electro-chemical philosopher is well acquainted

* A single paper thus prepared could insulate the electricity of a trough of forty pairs of plates.

with some practical results obtained from the voltaic battery by MM. Gay-Lussac and Thénard, and given in the first forty-five pages of their 'Recherches Physico-Chimiques'. Although the following results are generally of the same nature, yet the advancement made in this branch of science of late years, the knowledge of the definite action of electricity, and the more accurate and philosophical mode of estimating the results by the equivalents of zinc consumed, will be their sufficient justification.

1137. *Nature and strength of the acid.*—My battery of forty pairs of three-inch plates was charged with acid consisting of 200 parts water and 9 oil of vitriol. Each plate lost, in the average of the experiments, 4.66 equivalents of zinc for the equivalent of water decomposed in the volta-electrometer, or the whole battery 186.4 equivalents of zinc. Being charged with a mixture of 200 water and 16 of the muriatic acid, each plate lost 3.8, equivalents of zinc for the water decomposed, or the whole battery 152 equivalents of zinc. Being charged with a mixture of 200 water and 8 nitric acid, each plate lost 1.85, equivalents of zinc for one equivalent of water decomposed, or the whole battery 74.16 equivalents of zinc. The sulphuric and muriatic acids evolved much hydrogen at the plates in the trough; the nitric acid no gas whatever. The relative strengths of the original acids have already been given (1127.); but a difference in that respect makes no important difference in the results when thus expressed by equivalents (1140.).

1138. Thus nitric acid proves to be the best for this purpose; its superiority appears to depend upon its favouring the electrolyzation of the liquid in the cells of the trough upon the principles already explained (905. 973. 1022.), and consequently favouring the transmission of the electricity, and therefore the production of transferable power (1120.).

1139. The addition of nitric acid might, consequently, be expected to improve sulphuric and muriatic acids. Accordingly, when the same trough was charged with a mixture of 200 water, 9 oil of vitriol, and 4 nitric acid, the consumption of zinc was at each plate 2.786, and for the whole battery 111.5, equivalents. When the charge was 200 water, 9 oil of vitriol, and 8 nitric acid, the loss per plate was 2.26, or for the whole battery 90.4, equivalents. When the trough was charged with a

mixture of 200 water, 16 muriatic acid, and 6 nitric acid, the loss per plate was 2·11, or for the whole battery 84·4, equivalents. Similar results were obtained with my battery of twenty pairs of four-inch plates (1129.). Hence it is evident that the nitric acid was of great service when mingled with the sulphuric acid; and the charge generally used after this time for ordinary experiments consisted of 200 water, 4½ oil of vitriol, and 4 nitric acid.

1140. It is not to be supposed that the different strengths of the acids produced the differences above; for within certain limits I found the electrolytic effects to be nearly as the strengths of the acids, so as to leave the expression of force, when given in equivalents, almost constant. Thus, when the trough was charged with a mixture of 200 water and 8 nitric acid, each plate lost 1·854 equivalent of zinc. When the charge was 200 water and 16 nitric acid, the loss per plate was 1·82 equivalent. When it was 200 water and 32 nitric acid, the loss was 2·1 equivalents. The differences here are not greater than happen from unavoidable irregularities, depending on other causes than the strength of acid.

1141. Again, when a charge consisting of 200 water, 4½ oil of vitriol, and 4 nitric acid was used, each zinc plate lost 2·16 equivalents; when the charge with the same battery was 200 water, 9 oil of vitriol, and 8 nitric acid, each zinc plate lost 2·26 equivalents.

1142. I need hardly say that no copper is dissolved during the regular action of the voltaic trough. I have found that much ammonia is formed in the cells when nitric acid, either pure or mixed with sulphuric acid is used. It is produced in part as a secondary result at the cathodes (663.) of the different portions of fluid constituting the necessary electrolyte, in the cells.

1143. *Uniformity of the charge.*—This is a most important point, as I have already shown experimentally (1042. &c.). Hence one great advantage of Dr. Hare's mechanical arrangement of his trough.

1144. *Purity of the zinc.*—If pure zinc could be obtained, it would be very advantageous in the construction of the voltaic apparatus (998.). Most zincs, when put into dilute sulphuric acid, leave more or less of an insoluble matter upon the sur-

face in the form of a crust, which contains various metals, as copper, lead, zinc, iron, cadmium, &c., in the metallic state. Such particles, by discharging part of the transferable power, render it, as to the whole battery, local; and so diminish the effect. As an indication connected with the more or less perfect action of the battery, I may mention that no gas ought to rise from the zinc plates. The more gas which is generated upon these surfaces, the greater is the local action and the less the transferable force. The investing crust is also inconvenient, by preventing the displacement and renewal of the charge upon the surface of the zinc. Such zinc as, dissolving in the cleanest manner in a dilute acid, dissolves also the slowest, is the best; zinc which contains much copper should especially be avoided. I have generally found rolled Liege or Mosselman's zinc the purest; and to the circumstance of having used such zinc in its construction attribute in part the advantage of the new battery (1134.).

1145. *Foulness of the zinc plates.*—After use, the plates of a battery should be cleaned from the metallic powder upon their surfaces, especially if they are employed to obtain the laws of action of the battery itself. This precaution was always attended to with the porcelain trough batteries in the experiments described (1125., &c.). If a few foul plates are mingled with many clean ones, they make the action in the different cells irregular, and the transferable power is accordingly diminished, whilst the local and wasted power is increased. No old charge containing copper should be used to excite a battery.

1146. *New and old plates.*—I have found voltaic batteries far more powerful when the plates were new than when they have been used two or three times; so that a new and an used battery cannot be compared together, or even a battery with itself on the first and after times of use. My trough of twenty pairs of four-inch plates, charged with acid consisting of 200 water, $4\frac{1}{2}$ oil of vitriol, and 4 nitric acid, lost, upon the first time of being used, 2.32 equivalents per plate. When used after the fourth time with the same charge, the loss was from 3.26 to 4.47 equivalents per plate; the average being 3.7 equivalents. The first time the forty pair of plates (1124.) were used, the loss at each plate was only 1.65 equivalent; but afterwards it became 2.16, 2.17, 2.52. The first time twenty pair of four-inch plates in porcelain troughs

were used, they lost, per plate, only 3·7 equivalents; but after that, the loss was 5·25, 5·36, 5·9 equivalents. Yet in all these cases the zincs had been well cleaned from adhering copper, &c., before each trial of power.

1147. With the rolled zinc the fall in force soon appeared to become constant, *i. e.* to proceed no further. But with the cast zinc plates belonging to the porcelain troughs, it appeared to continue, until at last, with the same charge, each plate lost above twice as much zinc for a given amount of action as at first. These troughs were, however, so irregular that I could not always determine the circumstances affecting the amount of electrolytic action.

1148. *Vicinity of the copper and zinc.*—The importance of this point in the construction of voltaic arrangements, and the greater power, as to immediate action, which is obtained when the zinc and copper surfaces are near to each other than when removed further apart, are well known. I find that the power is not only greater on the instant, but also that the sum of transferable power, in relation to the whole sum of chemical action at the plates, is much increased. The cause of this gain is very evident. Whatever tends to retard the circulation of the transferable force, (*i. e.* the electricity,) diminishes the proportion of such force, and increases the proportion of that which is local (996. 1120.). Now the liquid in the cells possesses this retarding power, and therefore acts injuriously, in greater or less proportion, according to the quantity of it between the zinc and copper plates, *i. e.* according to the distances between their surfaces. A trough, therefore, in which the plates are only half the distance asunder at which they are placed in another, will produce more transferable, and less local, force than the latter; and thus, because the electrolyte in the cells can transmit the current more readily, both the intensity and quantity of electricity is increased for a given consumption of zinc. To this circumstance mainly I attribute the superiority of the trough I have described (1134.).

1149. The superiority of *double coppers* over single plates also depends in part upon diminishing the resistance offered by the electrolyte between the metals. For, in fact, with double coppers the sectional area of the interposed acid becomes nearly double that with single coppers, and therefore it more freely

transfers the electricity. Double coppers are, however, effective, mainly because they virtually double the acting surface of the zinc, or nearly so; for in a trough with single copper plates and the usual construction of cells, that surface of zinc which is not opposed to a copper surface is thrown almost entirely out of voltaic action, yet the acid continues to act upon it and the metal is dissolved, producing very little more than local effect (947. 996.). But when by doubling the copper, that metal is opposed to the second surface of the zinc plate, then a great part of the action upon the latter is converted into transferable force, and thus the power of the trough as to quantity of electricity is highly exalted.

1150. *First immersion of the plates.*—The great effect produced at the first immersion of the plates, (apart from their being new or used (1146.),) I have attributed elsewhere to the unchanged condition of the acid in contact with the zinc plate (1003. 1037.): as the acid becomes neutralized, its exciting power is proportionably diminished. Hare's form of trough secures much advantage of this kind, by mingling the liquid, and bringing what may be considered as a fresh surface of acid against the plates every time it is used immediately after a rest.

1151. *Number of plates**.—The most advantageous number of plates in a battery used for chemical decomposition, depends almost entirely upon the resistance to be overcome at the place of action; but whatever that resistance may be, there is a certain number which is more economical than either a greater or a less. Ten pairs of four-inch plates in a porcelain trough of the ordinary construction, acting in the volta-electrometer (1126.) upon dilute sulphuric acid of spec. grav. 1.314, gave an average consumption of 15.4 equivalents per plate, or 154 equivalents on the whole. Twenty pairs of the same plates, with the same acid, gave only a consumption of 5.5 per plate, or 110 equivalents upon the whole. When forty pairs of the same plates were used, the consumption was 3.54 equivalents per plate, or 141.6 upon the whole battery. Thus the consumption of zinc arranged as *twenty* plates was more advantageous than if arranged either as *ten* or as *forty*.

1152. Again, ten pairs of my four-inch plates (1129.) lost 6.76 each, or the whole ten 67.6 equivalents of zinc, in effect-

* Gay-Lussac and Thénard, Recherches Physico-Chimiques, tom. i. p. 29.

ing decomposition ; whilst twenty pairs of the same plates, excited by the same acid, lost 3·7 equivalents each, or on the whole 74 equivalents. In other comparative experiments of numbers, ten pairs of the three-inch plates (1125.), lost 3·725, or 37·25 equivalents upon the whole ; whilst twenty pairs lost 2·53 each, or 50·6 in all ; and forty pairs lost on an average 2·21, or 88·4 altogether. In both these cases, therefore, increase of numbers had not been advantageous as to the effective production of *transferable chemical power* from the *whole quantity of chemical force* active at the surfaces of excitation (1120.).

1153. But if I had used a weaker acid or a worse conductor in the volta-electrometer, then the number of plates which would produce the most advantageous effect would have risen ; or if I had used a better conductor than that really employed in the volta-electrometer, I might have reduced the number even to one ; as, for instance, when a thick wire is used to complete the circuit (865. &c.). And the cause of these variations is very evident, when it is considered that each successive plate in the voltaic apparatus does not add anything to the *quantity* of transferable power or electricity which the first plate can put into motion, provided a good conductor be present, but tends only to exalt the *intensity* of that quantity, so as to make it more able to overcome the obstruction of bad conductors (994. 1158).

1154. *Large or small plates**.—The advantageous use of large or small plates for electrolyzations will evidently depend upon the facility with which the transferable power or electricity can pass. If in a particular case the most effectual number of plates is known (1151.), then the addition of more zinc would be most advantageously made in increasing the *size* of the plates, and not their *number*. At the same time, large increase in the size of the plates would raise in a small degree the most favourable number.

1155. Large and small plates should not be used together in the same battery : the small ones occasion a loss of the power of the large ones, unless they be excited by an acid proportionably more powerful ; for with a certain acid they cannot transmit the same portion of electricity in a given time which the same acid can evolve by action on the larger plates.

* Gay-Lussac and Thénard, *Recherches Physico-Chimiques*, tom. i. p. 29.

1156. *Simultaneous decompositions.*—When the number of plates in a battery much surpasses the most favourable proportion (1151—1153.), two or more decompositions may be effected simultaneously with advantage. Thus my forty pairs of plates (1124.) produced in one volta-electrometer 22·8 cubic inches of gas. Being recharged exactly in the same manner, they produced in each of two volta-electrometers 21 cubical inches. In the first experiment the whole consumption of zinc was 88·4 equivalents, and in the second only 48·28 equivalents, for the whole of the water decomposed in both volta-electrometers.

1157. But when the twenty pairs of four-inch plates (1129.) were tried in a similar manner, the results were in the opposite direction. With one volta-electrometer 52 cubic inches of gas were obtained; with two, only 14·6 cubic inches from each. The quantity of charge was not the same in both cases, though it was of the same strength; but on rendering the results comparative by reducing them to equivalents (1126.), it was found that the consumption of metal in the first case was 74, and in the second case 97, equivalents for the *whole* of the water decomposed. These results of course depend upon the same circumstances of retardation, &c., which have been referred to in speaking of the proper number of plates (1151.).

1158. That the *transferring*, or, as it is usually called, *conducting*, power of an electrolyte which is to be decomposed, or other interposed body, should be rendered as good as possible*, is very evident (1020. 1120.). With a perfectly good conductor and a good battery, nearly all the electricity is passed, i. e. *nearly all* the chemical power becomes transferable, even with a single pair of plates (867.). With an interposed non-conductor, none of the chemical power becomes transferable. With an imperfect conductor more or less of the chemical power becomes transferable as the circumstances favouring the transfer of forces across the imperfect conductor are exalted or diminished: these circumstances are, actual increase or improvement of the conducting power, enlargement of the electrodes, approximation of the electrodes, and increased intensity of the passing current.

* Gay-Lussac and Thénard, *Recherches Physico-Chimiques*, tom. i. pp. 13, 15, 22.

1159. The introduction of common spring water in place of one of the volta-electrometers used with twenty pairs of four-inch plates (1156.) caused such obstruction as not to allow one fifteenth of the transferable force to pass which would have circulated without it. Thus fourteen fifteenths of the available force of the battery were destroyed, being converted into local force, (which was rendered evident by the evolution of gas from the zines,) and yet the platina electrodes in the water were three inches long, nearly an inch wide, and not a quarter of an inch apart.

1160. These points, *i. e.* the increase of conducting power, the enlargement of the electrodes, and their approximation, should be especially attended to in *volta-electrometers*. The principles upon which their utility depend are so evident that there can be no occasion for further development of them here.

Royal Institution,

October 11th, 1834.

ELEVENTH SERIES.

§ 18. *On Induction.* ¶ i. *Induction an action of contiguous particles.* ¶ ii. *Absolute charge of matter.* ¶ iii. *Electrometer and inductive apparatus employed.* ¶ iv. *Induction in curved lines.* ¶ v. *Specific inductive capacity.* ¶ vi. *General results as to induction.*

Received November 30,—Read December 21, 1837.

¶ i. *Induction an action of contiguous particles.*

1161. THE science of electricity is in that state in which every part of it requires experimental investigation; not merely for the discovery of new effects, but what is just now of far more importance, the development of the means by which the old effects are produced, and the consequent more accurate determination of the first principles of action of the most extraordinary and universal power in nature:—and to those philosophers who pursue the inquiry zealously yet cautiously, combining experiment with analogy, suspicious of their preconceived notions, paying more respect to a fact than a theory, not too hasty to generalize, and above all things, willing at every step to cross-examine their own opinions, both by reasoning and experiment, no branch of knowledge can afford so fine and ready a field for discovery as this. Such is most abundantly shown to be the case by the progress which electricity has made in the last thirty years: Chemistry and Magnetism have successively acknowledged its over-ruling influence; and it is probable that every effect depending upon the powers of inorganic matter, and perhaps most of those related to vegetable and animal life, will ultimately be found subordinate to it.

1162. Amongst the actions of different kinds into which electricity has conventionally been subdivided, there is, I think, none which excels, or even equals in importance that called *Induction*. It is of the most general influence in electrical phenomena, appearing to be concerned in every one of them, and has in reality the character of a first, essential, and fundamental

principle. Its comprehension is so important, that I think we cannot proceed much further in the investigation of the laws of electricity without a more thorough understanding of its nature; how otherwise can we hope to comprehend the harmony and even unity of action which doubtless governs electrical excitement by friction, by chemical means, by heat, by magnetic influence, by evaporation, and even by the living being?

1163. In the long-continued course of experimental inquiry in which I have been engaged, this general result has pressed upon me constantly, namely, the necessity of admitting two forces, or two forms or directions of a force (516. 517.), combined with the impossibility of separating these two forces (or electricities) from each other, either in the phenomena of statical electricity or those of the current. In association with this, the impossibility under any circumstances, as yet, of absolutely charging matter of any kind with one or the other electricity only, dwelt on my mind, and made me wish and search for a clearer view than any that I was acquainted with, of the way in which electrical powers and the particles of matter are related; especially in inductive actions, upon which almost all others appeared to rest.

1164. When I discovered the general fact that electrolytes refused to yield their elements to a current when in the solid state, though they gave them forth freely if in the liquid condition (380. 394. 402.), I thought I saw an opening to the elucidation of inductive action, and the possible subjugation of many dissimilar phenomena to one law. For let the electrolyte be water, a plate of ice being coated with platina foil on its two surfaces, and these coatings connected with any continued source of the two electrical powers, the ice will charge like a Leyden arrangement, presenting a case of common induction, but no current will pass. If the ice be liquefied, the induction will fall to a certain degree, because a current can now pass; but its passing is dependent upon a *peculiar molecular arrangement* of the particles consistent with the transfer of the elements of the electrolyte in opposite directions, the degree of discharge and the quantity of elements evolved being exactly proportioned to each other (377. 783.). Whether the charging of the metallic coating be effected by a powerful electrical machine, a strong and large voltaic battery, or a single pair of plates, makes

no difference in the principle, but only in the degree of action (360.). Common induction takes place in each case if the electrolyte be solid, or if fluid, chemical action and decomposition ensue, provided opposing actions do not interfere; and it is of high importance occasionally thus to compare effects in their extreme degrees, for the purpose of enabling us to comprehend the nature of an action in its weak state, which may be only sufficiently evident to us in its stronger condition (451.). As, therefore, in the electrolytic action, *induction* appeared to be the *first* step, and *decomposition* the *second* (the power of separating these steps from each other by giving the solid or fluid condition to the electrolyte being in our hands); as the induction was the same in its nature as that through air, glass, wax, &c. produced by any of the ordinary means; and as the whole effect in the electrolyte appeared to be an action of the particles thrown into a peculiar or polarized state, I was led to suspect that common induction itself was in all cases an *action of contiguous particles**, and that electrical action at a distance (*i. e.* ordinary inductive action) never occurred except through the influence of the intervening matter.

1165. The respect which I entertain towards the names of Epinus, Cavendish, Poisson, and other most eminent men, all of whose theories I believe consider induction as an action at a distance and in straight lines, long indisposed me to the view I have just stated; and though I always watched for opportunities to prove the opposite opinion, and made such experiments occasionally as seemed to bear directly on the point, as, for instance, the examination of electrolytes, solid and fluid, whilst under induction by polarized light (951. 955.), it is only of late, and by degrees, that the extreme generality of the subject has urged me still further to extend my experiments and publish my view. At present I believe ordinary induction in all cases to be an action of contiguous particles consisting in a species of polarity, instead of being an action of either particles or masses at sensible distances; and if this be true, the di-

* The word *contiguous* is perhaps not the best that might have been used here and elsewhere; for as particles do not touch each other it is not strictly correct. I was induced to employ it, because in its common acceptation it enabled me to state the theory plainly and with facility. By contiguous particles I mean those which are next.—*Dec.* 1838.

stinction and establishment of such a truth must be of the greatest consequence to our further progress in the investigation of the nature of electric forces. The linked condition of electrical induction with chemical decomposition; of voltaic excitement with chemical action; the transfer of elements in an electrolyte; the original cause of excitement in all cases; the nature and relation of conduction and insulation; of the direct and lateral or transverse action constituting electricity and magnetism; with many other things more or less incomprehensible at present, would all be affected by it, and perhaps receive a full explanation in their reduction under one general law.

1166. I searched for an unexceptionable test of my view, not merely in the accordance of known facts with it, but in the consequences which would flow from it if true; especially in those which would not be consistent with the theory of action at a distance. Such a consequence seemed to me to present itself in the direction in which inductive action could be exerted. If in straight lines only, though not perhaps decisive, it would be against my view; but if in curved lines also, that would be a natural result of the action of contiguous particles, but, as I think, utterly incompatible with action at a distance, as assumed by the received theories, which, according to every fact and analogy we are acquainted with, is always in straight lines.

1167. Again, if induction be an action of contiguous particles, and also the first step in the process of electrolyzation (1164. 949.), there seemed reason to expect some particular relation of it to the different kinds of matter through which it would be exerted, or something equivalent to a *specific electric induction* for different bodies, which, if it existed, would unequivocally prove the dependence of induction on the particles; and though this, in the theory of Poisson and others, has never been supposed to be the case, I was soon led to doubt the received opinion, and have taken great pains in subjecting this point to close experimental examination.

1168. Another ever-present question on my mind has been, whether electricity has an actual and independent existence as a fluid or fluids, or was a mere power of matter, like what we conceive of the attraction of gravitation. If determined either way it would be an enormous advance in our knowledge; and as

having the most direct and influential bearing on my notions, I have always sought for experiments which would in any way tend to elucidate that great inquiry. It was in attempts to prove the existence of electricity separate from matter, by giving an independent charge of either positive or negative power only, to some one substance, and the utter failure of all such attempts, whatever substance was used or whatever means of exciting or *evolving* electricity were employed, that first drove me to look upon induction as an action of the particles of matter, each having *both* forces developed in it in exactly equal amount. It is this circumstance, in connection with others, which makes me desirous of placing the remarks on absolute charge first, in the order of proof and argument, which I am about to adduce in favour of my view, that electric induction is an action of the contiguous particles of the insulating medium or *dielectric**.

¶ ii. *On the absolute charge of matter.*

1169. Can matter, either conducting or non-conducting, be charged with one electric force independently of the other, in any degree, either in a sensible or latent state?

1170. The beautiful experiments of Coulomb upon the equality of action of *conductors*, whatever their substance, and the residence of *all* the electricity upon their surfaces †, are sufficient, if properly viewed, to prove that *conductors cannot be bodily charged*; and as yet no means of communicating electricity to a conductor so as to place its particles in relation to one electricity, and not at the same time to the other in exactly equal amount, has been discovered.

1171. With regard to electrics or non-conductors, the conclusion does not at first seem so clear. They may easily be electrified bodily, either by communication (1247.) or excitement; but being so charged, every case in succession, when examined, came out to be a case of induction, and not of absolute charge. Thus, glass within conductors could easily have parts not in contact with the conductor brought into an excited state; but it was always found that a portion of the inner sur-

* I use the word *dielectric* to express that substance through or across which the electric forces are acting.—*Dec.* 1833.

† Mémoires de l'Académie, 1786, pp. 67. 69. 72; 1787, p. 452.

face of the conductor was in an opposite and equivalent state, or that another part of the glass itself was in an equally opposite state, an *inductive* charge and not an *absolute* charge having been acquired.

1172. Well-purified oil of turpentine, which I find to be an excellent liquid insulator for most purposes, was put into a metallic vessel, and, being insulated, an endeavour was made to charge its particles, sometimes by contact of the metal with the electrical machine, and at others by a wire dipping into the fluid within; but whatever the mode of communication, no electricity of one kind only was retained by the arrangement, except what appeared on the exterior surface of the metal, that portion being present there only by an inductive action through the air to the surrounding conductors. When the oil of turpentine was confined in glass vessels, there were at first some appearances as if the fluid did receive an absolute charge of electricity from the charging wire, but these were quickly reduced to cases of common induction jointly through the fluid, the glass, and the surrounding air.

1173. I carried these experiments on with air to a very great extent. I had a chamber built, being a cube of twelve feet. A slight cubical wooden frame was constructed, and copper wire passed along and across it in various directions, so as to make the sides a large net-work, and then all was covered in with paper, placed in close connexion with the wires, and supplied in every direction with bands of tin foil, that the whole might be brought into good metallic communication, and rendered a free conductor in every part. This chamber was insulated in the lecture-room of the Royal Institution; a glass tube about six feet in length was passed through its side, leaving about four feet within and two feet on the outside, and through this a wire passed from the large electrical machine (290.) to the air within. By working the machine, the air in this chamber could be brought into what is considered a highly electrified state (being, in fact, the same state as that of the air of a room in which a powerful machine is in operation), and at the same time the outside of the insulated cube was everywhere strongly charged. But putting the chamber in communication with the perfect discharging train described in a former series (292.), and working the machine so as to bring the air within

to its utmost degree of charge if I quickly cut off the connexion with the machine, and at the same moment or instantly after insulated the eube, the air within had not the least power to communicate a further charge to it. If any portion of the air was electrified, as glass or other insulators may be charged (1171.), it was accompanied by a corresponding opposite action *within* the eube, the whole effect being merely a case of induction. Every attempt to charge air bodily and independently with the least portion of either electricity failed.

1174. I put a delicate gold-leaf electrometer within the eube, and then charged the whole by an *outside* communication, very strongly, for some time together; but neither during the charge or after the discharge did the electrometer or air within show the least signs of electricity. I charged and discharged the whole arrangement in various ways, but in no case could I obtain the least indication of an absolute charge; or of one by induction in which the electricity of one kind had the smallest superiority in quantity over the other. I went into the eube and lived in it, and using lighted candles, electrometers, and all other tests of electrical states, I could not find the least influence upon them, or indication of anything particular given by them, though all the time the outside of the eube was powerfully charged, and large sparks and brushes were darting off from every part of its outer surface. The conclusion I have come to is, that non-conductors, as well as conductors, have never yet had an absolute and independent charge of one electricity communicated to them, and that to all appearance such a state of matter is impossible.

1175. There is another view of this question which may be taken under the supposition of the existence of an electric fluid or fluids. It may be impossible to have one fluid or state in a free condition without its producing by induction the other, and yet possible to have cases in which an isolated portion of matter in one condition being uncharged, shall, by a change of state, evolve one electricity or the other: and though such evolved electricity might immediately induce the opposite state in its neighbourhood, yet the mere evolution of one electricity without the other in the *first instance*, would be a very important fact in the theories which assume a fluid or fluids; these

theories as I understand them assigning not the slightest reason why such an effect should not occur.

1176. But on searching for such cases I cannot find one. Evolution by friction, as is well known, gives both powers in equal proportion. So does evolution by chemical action, notwithstanding the great diversity of bodies which may be employed, and the enormous quantity of electricity which can in this manner be evolved (371. 376. 861. 868. 961.). The more promising cases of change of state, whether by evaporation, fusion, or the reverse processes, still give both forms of the power in *equal* proportion; and the cases of splitting of mica and other crystals, the breaking of sulphur, &c., are subject to the same law of limitation.

1177. As far as experiment has proceeded, it appears, therefore, impossible either to evolve or make disappear one electric force without equal and corresponding change in the other. It is also equally impossible experimentally to charge a portion of matter with one electric force independently of the other. Charge always implies *induction*, for it can in no instance be effected without; and also the presence of the *two* forms of power, equally at the moment of the development and afterwards. There is no *absolute* charge of matter with one fluid; no latency of a single electricity. This though a negative result is an exceedingly important one, being probably the consequence of a natural impossibility, which will become clear to us when we understand the true condition and theory of the electric power.

1178. The preceding considerations already point to the following conclusions: bodies cannot be charged absolutely, but only relatively, and by a principle which is the same with that of *induction*. All *charge* is sustained by induction. All phenomena of *intensity* include the principle of induction. All *excitation* is dependent on or directly related to induction. All *currents* involve previous intensity and therefore previous induction. INDUCTION appears to be the essential function both in the first development and the consequent phenomena of electricity.

¶ iii. *Electrometer and inductive apparatus employed.*

1179. Leaving for a time the further consideration of the

preceeding facts until they can be collated with other results bearing directly on the great question of the nature of induction, I will now describe the apparatus I have had occasion to use; and in proportion to the importance of the principles sought to be established is the necessity of doing this so clearly, as to leave no doubt of the results behind.

1180. *Electrometer.* The measuring instrument I have employed has been the torsion balance electrometer of Coulomb, constructed, generally, according to his directions*, but with certain variations and additions, which I will briefly describe. The lower part was a glass cylinder eight inches in height and eight inches in diameter; the tube for the torsion thread was seventeen inches in length. The torsion thread itself was not of metal, but glass, according to the excellent suggestion of the late Dr. Ritchie †. It was twenty inches in length, and of such tenuity that when the shell-lac lever and attached ball, &c. were connected with it, they made about ten vibrations in a minute. It would bear torsion through four revolutions or 1440° , and yet, when released, return accurately to its position; probably it would have borne considerably more than this without injury. The repelled ball was of pith, gilt, and was 0.3 of an inch in diameter. The horizontal stem or lever supporting it was of shell-lac, according to Coulomb's direction, the arm carrying the ball being 2.4 inches long, and the other only 1.2 inches: to this was attached the vane, also described by Coulomb, which I found to answer admirably its purpose of quickly destroying vibrations. That the inductive action within the electrometer might be uniform in all positions of the repelled ball and in all states of the apparatus, two bands of tin foil, about an inch wide each, were attached to the inner surface of the glass cylinder, going entirely round it, at the distance of 0.4 of an inch from each other, and at such a height that the intermediate clear surface was in the same horizontal plane with the lever and ball. These bands were connected with each other and with the earth, and, being perfect conductors, always exerted a uniform influence on the electrified balls within, which the glass surface, from its irregularity of condition at different times, I found, did not. For the purpose of keeping the air

* Mémoires de l'Académie, 1785, p. 570.

† Philosophical Transactions, 1830.

within the electrometer in a constant state as to dryness, a glass dish, of such size as to enter easily within the cylinder, had a layer of fused potash placed within it, and this being covered with a disc of fine wire-gauze to render its inductive action uniform at all parts, was placed within the instrument at the bottom and left there.

1181. The moveable ball used to take and measure the portion of electricity under examination, and which may be called the *repelling*, or the *carrier*, ball, was of soft alder wood, well and smoothly gilt. It was attached to a fine shell-lac stem, and introduced through a hole into the electrometer according to Coulomb's method: the stem was fixed at its upper end in a block or vice, supported on three short feet; and on the surface of the glass cover above was a plate of lead with stops on it, so that when the carrier ball was adjusted in its right position, with the vice above bearing at the same time against these stops, it was perfectly easy to bring away the carrier-ball and restore it to its place again very accurately, without any loss of time.

1182. It is quite necessary to attend to certain precautions respecting these balls. If of pith alone they are bad; for when very dry, that substance is so imperfect a conductor that it neither receives nor gives a charge freely, and so, after contact with a charged conductor, it is liable to be in an uncertain condition. Again, it is difficult to turn pith so smooth as to leave the ball, even when gilt, so free from irregularities of form, as to retain its charge undiminished for a considerable length of time. When, therefore, the balls are finally prepared and gilt they should be examined; and being electrified, unless they can hold their charge with very little diminution for a considerable time, and yet be discharged instantly and perfectly by the touch of an uninsulated conductor, they should be dismissed.

1183. It is, perhaps, unnecessary to refer to the graduation of the instrument, further than to explain how the observations were made. On a circle or ring of paper on the outside of the glass cylinder, fixed so as to cover the internal lower ring of tinfoil, were marked four points corresponding to angles of 90° ; four other points exactly corresponding to these points being marked on the upper ring of tinfoil within. By these

and the adjusting screws on which the whole instrument stands, the glass torsion thread could be brought accurately into the centre of the instrument and of the graduations on it. From one of the four points on the exterior of the cylinder a graduation of 90° was set off, and a corresponding graduation was placed upon the upper tinfoil on the opposite side of the cylinder within; and a dot being marked on that point of the surface of the repelled ball nearest to the side of the electrometer, it was easy, by observing the line which this dot made with the lines of the two graduations just referred to, to ascertain accurately the position of the ball. The upper end of the glass thread was attached, as in Coulomb's original electrometer, to an index, which had its appropriate graduated circle, upon which the degree of torsion was ultimately to be read off.

1184. After the levelling of the instrument and adjustment of the glass thread, the blocks which determine the place of the *carrier ball* are to be regulated (1181.) so that when the carrier arrangement is placed against them, the centre of the ball may be in the radius of the instrument corresponding to 0° on the lower graduation or that on the side of the electrometer, and at the same level and distance from the centre as the *repelled ball* on the suspended torsion lever. Then the torsion index is to be turned until the ball connected with it (the repelled ball) is accurately at 30° , and finally the graduated arc belonging to the torsion index is to be adjusted so as to bring 0° upon it to the index. This state of the instrument was adopted as that which gave the most direct expression of the experimental results, and in the form having fewest variable errors; the angular distance of 30° being always retained as the standard distance to which the balls were in every case to be brought, and the whole of the torsion being read off at once on the graduated circle above. Under these circumstances the distance of the balls from each other was not merely the same in degree, but their position in the instrument, and in relation to every part of it, was actually the same every time that a measurement was made; so that all irregularities arising from slight difference of form and action in the instrument and the bodies around were avoided. The only difference which could occur in the position of anything within, consisted in the deflection of the torsion thread from a vertical position, more or less, according to the

force of repulsion of the balls ; but this was so slight as to cause no interfering difference in the symmetry of form within the instrument, and gave no error in the amount of torsion force indicated on the graduation above.

1185. Although the constant angular distance of 30° between the centres of the balls was adopted, and found abundantly sensible, for all ordinary purposes, yet the facility of rendering the instrument far more sensible by diminishing this distance was at perfect command ; the results at different distances being very easily compared with each other either by experiment, or, as they are inversely as the squares of the distances, by calculation.

1186. The Coulomb balance electrometer requires experience to be understood ; but I think it a very valuable instrument in the hands of those who will take pains by practice and attention to learn the precautions needful in its use. Its insulating condition varies with circumstances, and should be examined before it is employed in experiments. In an ordinary and fair condition, when the balls were so electrified as to give a repulsive torsion force of 400° at the standard distance of 30° , it took nearly four hours to sink to 50° at the same distance ; the average loss from 400° to 300° being at the rate of $2^\circ\cdot7$ per minute, from 300° to 200° of $1^\circ\cdot7$ per minute, from 200° to 100° of $1^\circ\cdot3$ per minute, and from 100° to 50° of $0^\circ\cdot87$ per minute. As a complete measurement by the instrument may be made in much less than a minute, the amount of loss in that time is but small, and can easily be taken into account.

1187. *The inductive apparatus.*—My object was to examine inductive action carefully when taking place through different media, for which purpose it was necessary to subject these media to it in exactly similar circumstances, and in such quantities as should suffice to eliminate any variations they might present. The requisites of the apparatus to be constructed were, therefore, that the inducing surfaces of the conductors should have a constant form and state, and be at a constant distance from each other ; and that either solids, fluids, or gases might be placed and retained between these surfaces with readiness and certainty, and for any length of time.

1188. The apparatus used may be described in general terms

as consisting of two metallic spheres of unequal diameter, placed, the smaller within the larger, and concentric with it; the interval between the two being the space through which the induction was to take place. A section of it is given (Plate VII. fig. 104.) on a scale of one half: *a, a* are the two halves of a brass sphere, with an air-tight joint at *b*, like that of the Magdeburg hemispheres, made perfectly flush and smooth inside so as to present no irregularity; *c* is a connecting piece by which the apparatus is joined to a good stop-cock *d*, which is itself attached either to the metallic foot *e*, or to an air pump. The aperture within the hemisphere at *f* is very small; *g* is a brass collar fitted to the upper hemisphere, through which the shell-lac support of the inner ball and its stem passes; *h* is the inner ball, also of brass; it screws on to a brass stem *i*, terminated above by a brass ball B; *l, l* is a mass of shell-lac, moulded carefully on to *i*, and serving both to support and insulate it and its balls *h, B*. The shell-lac stem *l* is fitted into the socket *g*, by a little ordinary resinous cement, more fusible than shell-lac, applied at *m m* in such a way as to give sufficient strength and render the apparatus air-tight there, yet leave as much as possible of the lower part of the shell-lac stem untouched, as an insulation between the ball *h* and the surrounding sphere *a, a*. The ball *h* has a small aperture at *n*, so that when the apparatus is exhausted of one gas and filled with another, the ball *h* may itself also be exhausted and filled, that no variation of the gas in the interval *o* may occur during the course of an experiment.

1189. It will be unnecessary to give the dimensions of all the parts, since the drawing is to a scale of one half: the inner ball has a diameter of 2.33 inches, and the surrounding sphere an internal diameter of 3.57 inches. Hence the width of the intervening space, through which the induction is to take place, is 0.62 of an inch; and the extent of this space or plate, *i. e.* the surface of a medium sphere, may be taken as twenty-seven square inches, a quantity considered as sufficiently large for the comparison of different substances. Great care was taken in finishing well the inducing surfaces of the ball *h* and sphere *a, a*; and no varnish or lacquer was applied to them, or to any part of the metal of the apparatus.

1190. The attachment and adjustment of the shell-lac stem

was a matter requiring considerable care, especially as, in consequence of its cracking, it had frequently to be renewed. The best lac was chosen and applied to the wire *i*, so as to be in good contact with it everywhere, and in perfect continuity throughout its own mass. It was not smaller than is given by scale in the drawing, for when less it frequently cracked within a few hours after it was cold. I think that very slow cooling or annealing improved its quality in this respect. The collar *g* was made as thin as could be, that the lac might be as wide there as possible. In order that at every re-attachment of the stem to the upper hemisphere the ball *h* might have the same relative position, a gauge *p* (fig. 105.) was made of wood, and this being applied to the ball and hemisphere whilst the cement at *m* was still soft, the bearings of the ball at *q q*, and the hemisphere at *r r*, were forced home, and the whole left until cold. Thus all difficulty in the adjustment of the ball in the sphere was avoided.

1191. I had occasion at first to attach the stem to the socket by other means, as a band of paper or a plugging of white silk thread; but these were very inferior to the cement, interfering much with the insulating power of the apparatus.

1192. The retentive power of this apparatus was, when in good condition, better than that of the electrometer (1186.) *i. e.* the proportion of loss of power was less. Thus when the apparatus was electrified, and also the balls in the electrometer, to such a degree, that after the inner ball had been in contact with the top *k* of the ball of the apparatus, it caused a repulsion indicated by 600° of torsion force, then in falling from 600° to 400° the average loss was $8^\circ\cdot6$ per minute; from 400° to 300° the average loss was $2^\circ\cdot6$ per minute; from 300° to 200° it was $1^\circ\cdot7$ per minute; from 200° to 170° it was 1° per minute. This was after the apparatus had been charged for a short time; at the first instant of charging there is an apparent loss of electricity, which can only be comprehended hereafter (1207. 1250.).

1193. When the apparatus loses its insulating power suddenly, it is almost always from a crack near to or within the brass socket. These cracks are usually transverse to the stem. If they occur at the part attached by common cement to the socket, the air cannot enter, and thus constituting vacua, they

conduct away the electricity and lower the charge, as fast almost as if a piece of metal had been introduced there. Occasionally stems in this state, being taken out and cleared from the common cement, may by the careful application of the heat of a spirit-lamp, be so far softened and melted as to restore the perfect continuity of the parts; but if that does not succeed in replacing things in a good condition, the remedy is a new shell-lae stem.

1194. The apparatus when in order could easily be exhausted of air and filled with any given gas; but when that gas was acid or alkaline, it could not properly be removed by the air-pump, and yet required to be perfectly cleared away. In such cases the apparatus was opened and emptied of gas; and with respect to the inner ball *h*, it was washed out two or three times with distilled water introduced at the screw-hole, and then being heated above 212° , air was blown through to render the interior perfectly dry.

1195. The inductive apparatus described is evidently a Leyden phial, with the advantage, however, of having the *dielectric* or insulating medium changed at pleasure. The balls *h* and B, with the connecting-wire *i*, constitute the charged conductor, upon the surface of which all the electric force is resident by virtue of induction (1178.). Now though the largest portion of this induction is between the ball *h* and the surrounding sphere *a a*, yet the wire *i* and the ball B determine a part of the induction from their surfaces towards the external surrounding conductors. Still, as all things in that respect remain the same, whilst the medium within at *o o*, may be varied, any changes exhibited by the whole apparatus will in such cases depend upon the variations made in the interior; and these were the changes I was in search of, the negation or establishment of such differences being the great object of my inquiry. I considered that these differences, if they existed, would be most distinctly set forth by having two apparatus of the kind described, precisely similar in every respect; and then, *different insulating media* being within, to charge one and measure it, and after dividing the charge with the other, to observe what the ultimate conditions of both were. If insulating media really had any specific differences in favouring or opposing inductive action through them, such differences, I

conceived, could not fail of being developed by such a process.

1196. I will wind up this description of the apparatus, and explain the precautions necessary to their use, by describing the form and order of the experiments made to prove their equality when both contained common air. In order to facilitate reference I will distinguish the two by the terms App. i. and App. ii.

1197. The electrometer is first to be adjusted and examined (1184.), and the app. i. and ii. are to be perfectly discharged. A Leyden phial is to be charged to such a degree that it would give a spark of about one-sixteenth or one-twentieth of an inch in length between two balls of half an inch diameter; and the carrier ball of the electrometer being charged by this phial, is to be introduced into the electrometer, and the lever ball brought by the motion of the torsion index against it; the charge is thus divided between the balls, and repulsion ensues. It is useful then to bring the repelled ball to the standard distance of 30° by the motion of the torsion index, and observe the force in degrees required for this purpose; this force will in future experiments be called *repulsion of the balls*.

1198. One of the inductive apparatus, as, for instance, app. i., is now to be charged from the Leyden phial, the latter being in the state it was in when used to charge the balls; the carrier ball is to be brought into contact with the top of its upper ball (*k*, fig. 104.), then introduced into the electrometer, and the repulsive force (at the distance of 30°) measured. Again, the carrier should be applied to the app. i. and the measurement repeated; the apparatus i. and ii. are then to be joined, so as to *divide* the charge, and afterwards the force of each measured by the carrier ball, applied as before, and the results carefully noted. After this both i. and ii. are to be discharged; then app. ii. charged, measured, divided with app. i., and the force of each again measured and noted. If in each case the half charges of app. i. and ii. are equal, and are together equal to the whole charge before division, then it may be considered as proved that the two apparatus are precisely equal in power, and fit to be used in cases of comparison between different insulating media or *dielectrics*.

1199. But the *precautions* necessary to obtain accurate re-

sults are numerous. The apparatus i. and ii. must always be placed on a thoroughly noninsulating medium. A mahogany table, for instance, is far from satisfactory in this respect, and therefore a sheet of tinfoil, connected with an extensive discharging train (292.), is what I have used. They must be so placed also as not to be too near each other, and yet equally exposed to the inductive influence of surrounding objects; and these objects, again, should not be disturbed in their position during an experiment, or else variations of induction upon the external ball B of the apparatus may occur, and so errors be introduced into the results. The carrier ball, when receiving its portion of electricity from the apparatus, should always be applied at the same part of the ball, as, for instance, the summit *k*, and always in the same way; variable induction from the vicinity of the head, hands, &c. being avoided, and the ball after contact being withdrawn upwards in a regular and constant manner.

1200. As the stem had occasionally to be changed (1190.), and the change might occasion slight variations in the position of the ball within, I made such a variation purposely, to the amount of an eighth of an inch (which is far more than ever could occur in practice), but did not find that it sensibly altered the relation of the apparatus, or its inductive condition *as a whole*. Another trial of the apparatus was made as to the effect of dampness in the air, one being filled with very dry air, and the other with air from over water. Though this produced no change in the result, except an occasional tendency to more rapid dissipation, yet the precaution was always taken when working with gases (1290.) to dry them perfectly.

1201. It is essential that the interior of the apparatus should be perfectly free from *dust or small loose particles*, for these very rapidly lower the charge and interfere on occasions when their presence and action would hardly be expected. To breathe on the interior of the apparatus and wipe it out quietly with a clean silk handkerchief, is an effectual way of removing them; but then the intrusion of other particles should be carefully guarded against, and a dusty atmosphere should for this and several other reasons be avoided.

1202. The shell-lac stem requires occasionally to be well wiped, to remove, in the first instance, the film of wax and ad-

hering matter which is upon it ; and afterwards to displace dirt and dust which will gradually attach to it in the course of experiments. I have found much to depend upon this precaution, and a silk handkerchief is the best wiper.

1203. But wiping and some other circumstances tend to give a charge to the surface of the shell-lae stem. This should be removed, for, if allowed to remain, it very seriously affects the degree of charge given to the carrier ball by the apparatus (1232.). This condition of the stem is best observed by discharging the apparatus, applying the carrier ball to the stem, touching it with the finger, insulating and removing it, and examining whether it has received any charge (by induction) from the stem ; if it has, the stem itself is in a charged state. The best method of removing the charge I have found to be, to cover the finger with a single fold of a silk handkerchief, and breathing on the stem, to wipe it immediately after with the finger ; the ball B and its connected wire, &c. being at the same time *uninsulated* : the wiping place of the silk must not be changed ; it then becomes sufficiently damp not to excite the stem, and is yet dry enough to leave it in a clean and excellent insulating condition. If the air be dusty, it will be found that a single charge of the apparatus will bring on an electric state of the outside of the stem, in consequence of the carrying power of the particles of dust ; whereas in the morning, and in a room which has been left quiet, several experiments can be made in succession without the stem assuming the least degree of charge.

1204. Experiments should not be made by candle or lamp light except with much care, for flames have great and yet unsteady powers of affecting and dissipating electrical charges.

1205. As a final observation on the state of the apparatus, they should retain their charges well and uniformly, and alike for both, and at the same time allow of a perfect and instantaneous discharge, giving afterwards no charge to the carrier ball, whatever part of the ball B it may be applied to (1218.).

1206. With respect to the balance electrometer, all the precautions that need be mentioned, are, that the carrier ball is to be preserved during the first part of an experiment in its electrified state, the loss of electricity which would follow upon its discharge being avoided ; and that in introducing it into the electrometer through the hole in the glass plate above, care

should be taken that it do not touch, or even come near to, the edge of the glass.

1207. When the whole charge in one apparatus is divided between the two, the gradual fall, apparently from dissipation, in the apparatus which has *received* the half charge is greater than in the one *originally* charged. This is due to a peculiar effect to be described hereafter (1250. 1251.), the interfering influence of which may be avoided to a great extent by going through the steps of the process regularly and quickly; therefore, after the original charge has been measured, in app. i. for instance, i. and ii. are to be symmetrically joined by their balls B, the carrier touching one of these balls at the same time; it is first to be removed, and then the apparatus separated from each other; app. ii. is next quickly to be measured by the carrier, then app. i.; lastly, ii. is to be discharged, and the discharged carrier applied to it to ascertain whether any residual effect is present (1205.), and app. i. being discharged is also to be examined in the same manner and for the same purpose.

1208. The following is an example of the division of a charge by the two apparatus, air being the dielectric in both of them. The observations are set down one under the other in the order in which they were taken, the left hand numbers representing the observations made on app. i., and the right hand numbers those on app. ii. App. i. is that which was originally charged, and after two measurements, the charge was divided with app. ii.

App. i.	App. ii.
	Balls 160°
	0°
254°
250
divided and instantly taken 122
124
1	after being discharged
	2 after being discharged.

1209. Without endeavouring to allow for the loss which must have been gradually going on during the time of the experiment, let us observe the results of the numbers as they stand. As 1° remained in app. i. in an undischargable state, 249° may be

taken as the utmost amount of the transferable or divisible charge, the half of which is $124^{\circ}5$. As app. ii. was free of charge in the first instance, and immediately after the division was found with 122° , this amount *at least* may be taken as what it had received. On the other hand 124° minus 1° , or 123° , may be taken as the half of the transferable charge retained by app. i. Now these do not differ much from each other, or from $124^{\circ}5$, the half of the full amount of transferable charge; and when the gradual loss of charge evident in the difference between 254° and 250° of app. i. is also taken into account, there is every reason to admit the result as showing an equal division of charge, *unattended by any disappearance of power* except that due to dissipation.

1210. I will give another result, in which app. ii. was first charged, and where the residual action of that apparatus was greater than in the former case.

App. i.	App. ii.
Balls 150°	
. . . .	152°
. . . .	148
divided and instantly taken	
70°	
. . . .	78
. . . .	5 immediately after discharge.
0 immediately after discharge.

1211. The transferable charge being $148^{\circ}-5^{\circ}$, its half is $71^{\circ}5$, which is not far removed from 70° , the half charge of i.; or from 73° , the half charge of ii.: these half charges again making up the sum of 143° , or just the amount of the whole transferable charge. Considering the errors of experiment, therefore, these results may again be received as showing that the apparatus were equal in inductive capacity, or in their powers of receiving charges.

1212. The experiments were repeated with charges of negative electricity with the same general results.

1213. That I might be sure of the sensibility and action of the apparatus, I made such a change in one as ought upon principle to increase its inductive force, *i. e.* I put a metallic lining into the lower hemisphere of app. i., so as to diminish the thickness of the intervening air in that part, from 0.62 to

0.435 of an inch : this lining was carefully shaped and rounded so that it should not present a sudden projection within at its edge, but a gradual transition from the reduced interval in the lower part of the sphere to the larger one in the upper.

1214. This change immediately caused app. i. to produce effects indicating that it had a greater aptness or capacity for induction than app. ii. Thus, when a transferable charge in app. ii. of 469° was divided with app. i., the former retained a charge of 225° , whilst the latter showed one of 227° , *i. e.* the former had lost 244° in communicating 227° to the latter : on the other hand, when app. i. had a transferable charge in it of 381° divided by contact with app. ii., it lost 181° only, whilst it gave to app. ii. as many as 194 :—the sum of the divided forces being in the first instance *less*, and in the second instance *greater* than the original undivided charge. These results are the more striking, as only one half of the interior of app. i. was modified, and they show that the instruments are capable of bringing out differences in inductive force from amongst the errors of experiment, when these differences are much less than that produced by the alteration made in the present instance.

¶ iv. *Induction in curved lines.*

1215. Amongst those results deduced from the molecular view of induction (1166.), which, being of a peculiar nature, are the best tests of the truth or error of the theory, the expected action in curved lines is, I think, the most important at present ; for, if shown to take place in an unexceptionable manner, I do not see how the old theory of action at a distance and in straight lines can stand, or how the conclusion that ordinary induction is an action of contiguous particles can be resisted.

1216. There are many forms of old experiments which might be quoted as favourable to, and consistent with the view I have adopted. Such are most cases of electro-chemical decomposition, electrical brushes, auras, sparks, &c. ; but as these might be considered equivocal evidence, inasmuch as they include a current and discharge, (though they have long been to me indications of prior molecular action (1230.)) I endeavoured to devise such experiments for first proofs as should not include transfer, but relate altogether to the pure simple inductive action of statical electricity.

1217. It was also of importanee to make these experiments in the simplest possible manner, using not more than one insulating medium or dielectrie at a time, lest differences of slow conduction should produce effects which might erroneously be supposed to result from induction in curved lines. It will be unnecessary to describe the steps of the investigation minutely ; I will at once proceed to the simplest mode of proving the faets, first in air and then in other insulating media.

1218. A eylinder of solid shell-lae, 0·9 of an inch in diameter and seven inches in length, was fixed upright in a wooden foot (fig. (106.) : it was made coneave or eupped at its upper extremity so that a brass ball or other small arrangement could stand upon it. The upper half of the stem having been excited *negatively* by friction with warm flannel, a brass ball, B, 1 inch in diameter, was plaeced on the top, and then the whole arrangement examined by the carrier ball and Coulomb's electrometer (1180. &c.). For this purpose the balls of the electrometer were charged *positively* to about 360° , and then the carrier being applied to various parts of the ball B, the two were uninsulated whilst in contact or in position, then insulated*, separated, and the charge of the carrier examined as to its nature and foree. Its electricity was always positive, and its foree at the different positions *a*, *b*, *c*, *d*, &c. (figs. 106. and 107.) observed in suecession, was as follows :

at <i>a</i>	. . .	above 1000°
<i>b</i>	it was . . .	149
<i>c</i>	270
<i>d</i>	512
<i>b</i>	130

1219. To comprehend the full foree of these results, it must first be understood, that all the charges of the ball B and the carrier are echarges by induction, from the aetion of the excited surface of the shell-lae eylinder ; for whatever electricity the ball B received by *communication* from the shell-lae, either in the first instance or afterwards, was removed by the uninsula-

* It can hardly be necessary for me to say here, that whatever general state the carrier ball acquired in any place where it was uninsulated and then insulated, it retained on removal from that place, notwithstanding that it might pass through other places that would have given to it, if uninsulated, a different condition.

ting contacts, only that due to induction remaining; and this is shown by the charges taken from the ball in this its uninsulated state being always positive, or of the contrary character to the electricity of the shell-lae. In the next place, the charges at *a*, *c*, and *d* were of such a nature as might be expected from an inductive action in straight lines, but that obtained at *b* is *not so*: it is clearly a charge by induction, but *induction in a curved line*; for the carrier ball whilst applied to *b*, and after its removal to a distance of six inches or more from B, could not, in consequence of the size of B, be connected by a straight line with any part of the excited and inducing shell-lae.

1220. To suppose that the upper part of the *uninsulated* ball B, should in some way be retained in an electrified state by that portion of the surface of the ball which is in sight of the shell-lae, would be in opposition to what we know already of the subject. Electricity is retained upon the surface of conductors only by induction (1178.); and though some persons may not be prepared as yet to admit this with respect to insulated conductors, all will as regards uninsulated conductors like the ball B; and to decide the matter we have only to place the carrier ball at *e* (fig. 107.), so that it shall not come in contact with B, insulate it by a metallic rod descending perpendicularly, insulate it, remove it, and examine its state; it will be found charged with the same kind of electricity as, and even to a *higher degree* (1224.) than, if it had been in contact with the summit of B.

1221. To suppose, again, that induction acts in some way *through or across* the metal of the ball, is negatived by the simplest considerations; but a fact in proof will be better. If instead of the ball B a small disc of metal be used, the carrier may be charged at, or above the middle of its upper surface; but if the plate be enlarged to about $1\frac{1}{2}$ or 2 inches in diameter, C (fig. 108.), then no charge will be given to the carrier at *f*, though when applied nearer to the edge at *g*, or even *above the middle* at *h*, a charge will be obtained; and this is true though the plate may be a mere thin film of gold-leaf. Hence it is clear that the induction is not *through* the metal, but through the surrounding air or *dielectric*, and that in curved lines.

1222. I had another arrangement, in which a wire passing downwards through the middle of the shell-lae cylinder to the earth, was connected with the ball B (fig. 109.) so as to keep

it in a constantly uninsulated state. This was a very convenient form of apparatus, and the results with it were the same as those just described.

1223. In another case the ball B was supported by a shell-lae stem, independently of the excited cylinder of shell-lae, and at half an inch distance from it; but the effects were the same. Then the brass ball of a charged Leyden jar was used in place of the excited shell-lae to produce induction; but this caused no alteration of the phenomena. Both positive and negative inducing charges were tried with the same general results. Finally, the arrangement was inverted in the air for the purpose of removing every possible objection to the conclusions, but they came out exactly the same.

1224. Some results obtained with a brass hemisphere instead of the ball B were exceedingly interesting. It was 1.36 of an inch in diameter, (fig. 110.), and being placed on the top of the excited shell-lae cylinder, the carrier ball was applied, as in the former experiments (1218.), at the respective positions delineated in the figure. At *i* the force was 112° , at *k* 108° , at *l* 65° , at *m* 35° ; the inductive force gradually diminishing, as might have been expected, to this point. But on raising the carrier to the position *n*, the charge increased to 87° ; and on raising it still higher to *o*, the charge still further increased to 105° : at a higher point still, *p*, the charge taken was smaller in amount, being 98° , and continued to diminish for more elevated positions. Here the induction fairly turned a corner. Nothing, in fact, can better show both the curved lines or courses of the inductive action, disturbed as they are from their rectilinear form by the shape, position, and condition of the metallic hemisphere; and also a *lateral tension*, so to speak, of these lines on one another:—all depending, as I conceive, on induction being an action of the contiguous particles of the dielectric, which being thrown into a state of polarity and tension, are in mutual relation by their forces in all directions.

1225. As another proof that the whole of these actions were inductive I may state a result which was exactly what might be expected, namely, that if uninsulated conducting matter was brought round and near to the excited shell-lae stem, then the inductive force was directed towards it, and could not be found on the top of the hemisphere. Removing this matter the lines

of force resumed their former direction. The experiment affords proofs of the lateral tension of these lines, and supplies a warning to remove such matter in repeating the above investigation.

1226. After these results on curved inductive action in air I extended the experiments to other gases, using first carbonic acid and then hydrogen: the phenomena were precisely those already described. In these experiments I found that if the gases were confined in vessels they required to be very large, for whether of glass or earthenware, the conducting power of such materials is so great that the induction of the excited shell-lac cylinder towards them is as much as if they were metal; and if the vessels be small, so great a portion of the inductive force is determined towards them that the lateral tension or mutual repulsion of the lines of force before spoken of (1224.), by which their inflexion is caused, is so much relieved in other directions, that no inductive charge will be given to the carrier ball in the positions *k, l, m, n, o, p*, (fig. 110.). A very good mode of making the experiment is to let large currents of the gases ascend or descend through the air, and carry on the experiments in these currents.

1227. These experiments were then varied by the substitution of a liquid dielectric, namely, *oil of turpentine*, in place of air and gases. A dish of thin glass well covered with a film of shell-lac, (1272.) which was found by trial to insulate well, had some highly rectified oil of turpentine put into it to the depth of half an inch, and being then placed upon the top of the brass hemisphere (fig. 110.), observations were made with the carrier ball as before (1224.). The results were the same, and the circumstance of some of the positions being within the fluid and some without, made no sensible difference.

1228. Lastly, I used a few solid dielectrics for the same purpose, and with the same results. These were shell-lac, sulphur, fused and cast borate of lead, flint glass well covered with a film of lac, and spermaceti. The following was the form of experiment with sulphur, and all were of the same kind. A square plate of the substance, two inches in extent and 0.6 of an inch in thickness, was cast with a small hole or depression in the middle of one surface to receive the carrier ball. This was placed upon the surface of the metal hemisphere (fig. 112.).

arranged on the excited lac as in former cases, and observations were made at *n*, *o*, *p*, and *g*. Great care was required in these experiments to free the sulphur or other solid substance from any charge it might previously have received. This was done by breathing and wiping (1203.), and the substance being found free from all electrical excitement, was then used in the experiment; after which it was removed and again examined, to ascertain that it had received no charge, but had acted really as a dielectric. With all these precautions the results were the same: and it is thus very satisfactory to obtain the curved inductive action through *solid bodies*, as any possible effect from the translation of charged particles in fluids or gases, which some persons might imagine to be the case, is here entirely negatived.

1229. In these experiments with solid dielectrics, the degree of charge assumed by the carrier ball at the situations *n*, *o*, *p* (fig. 112.), was decidedly greater than that given to the ball at the same places when air only intervened between it and the metal hemisphere. This effect is consistent with what will hereafter be found to be the respective relations of these bodies, as to their power of facilitating induction through them (1269. 1273. 1277.).

1230. I might quote *many* other forms of experiment, some old and some new, in which induction in curved or contorted lines take place, but think it unnecessary after the preceding results; I shall therefore mention but two. If a conductor A, (fig. 111.) be electrified, and an uninsulated metallic ball B, or even a plate, provided the edges be not too thin, be held before it, a small electrometer at *c* or at *d*, uninsulated, will give signs of electricity, opposite in its nature to that of A, and therefore caused by induction, although the influencing and influenced bodies cannot be joined by a right line passing through the air. Or if, the electrometers being removed, a point be fixed at the back of the ball in its uninsulated state as at C, this point will become luminous and discharge the conductor A. The latter experiment is described by Nicholson*, who, however, reasons erroneously upon it. As to its introduction here, though it is a case of discharge, the discharge is preceded by induction, and that induction must be in curved lines.

* Encyclopædia Britannica, vol. vi. p. 504.

1231. As argument against the received theory of induction and in favour of that which I have ventured to put forth, I cannot see how the preceding results can be avoided. The effects are clearly inductive effects produced by electricity, not in currents but in its statical state, and this induction is exerted in lines of force which, though in many experiments they may be straight, are here curved more or less according to circumstances. I use the term *line of inductive force* merely as a temporary conventional mode of expressing the direction of the power in cases of induction; and in the experiments with the hemisphere (1224.), it is curious to see how, when certain lines have terminated on the under surface and edge of the metal, those which were before lateral to them *expand and open out from each other*, some bending round and terminating their action on the upper surface of the hemisphere, and others meeting, as it were, above in their progress outwards, uniting their forces to give an increased charge to the carrier ball, at an *increased distance* from the source of power, and influencing each other so as to cause a second flexure in the contrary direction from the first one. All this appears to me to prove that the whole action is one of contiguous particles, related to each other, not merely in the lines which they may be conceived to form through the dielectric, between the *inductive* and the *inductive* surfaces (1483.), but in other lateral directions also. It is this which gives an effect equivalent to a lateral repulsion or expansion in the lines of force I have spoken of, and enables induction to turn a corner (1304.). The power, instead of being like that of gravity, which causes particles to act on each other through straight lines, whatever other particles may be between them, is more analogous to that of a series of magnetic needles, or to the condition of the particles considered as forming the whole of a straight or a curved magnet. So that in whatever way I view it, and with great suspicion of the influence of favourite notions over myself, I cannot perceive how the ordinary theory applied to explain induction can be a correct representation of that great natural principle of electrical action.

1232. I have had occasion in describing the precautions necessary in the use of the inductive apparatus, to refer to one founded on induction in curved lines (1203.); and after the experiments already described, it will easily be seen how great an

influence the shell-lac stem may exert upon the charge of the carrier ball when applied to the apparatus (1218.), unless that precaution be attended to.

1233. I think it expedient, next in the course of these experimental researches, to describe some effects due to *conduction*, obtained with such bodies as glass, lac, sulphur, &c., which had not been anticipated. Being understood, they will make us acquainted with certain precautions necessary in investigating the great question of specific inductive capacity.

1234. One of the inductive apparatus already described (1187, &c.) had a hemispherical cup of shell-lac introduced, which being in the interval between the inner ball and the lower hemisphere, nearly occupied the space there; consequently when the apparatus was charged, the lac was the dielectric or insulating medium through which the induction took place in that part. When this apparatus was first charged with electricity (1198.) up to a certain intensity, as 400° , measured by the COULOMB'S electrometer (1180.), it sank much faster from that degree than if it had been previously charged to a higher point, and had gradually fallen to 400° ; or than it would do if the charge were, by a second application, raised up again to 400° ; all other things remaining the same. Again, if after having been charged for some time, as fifteen or twenty minutes, it was suddenly and perfectly discharged, even the stem having all electricity removed from it (1203.), then the apparatus being left to itself, would gradually recover a charge, which in nine or ten minutes would rise up to 50° or 60° , and in one instance to 80° .

1235. The electricity, which in these cases returned from an apparently latent to a sensible state, was always of the same kind as that which had been given by the charge. The return took place at both the inducing surfaces; for if after the perfect discharge of the apparatus the whole was insulated, as the inner ball resumed a positive state the outer sphere acquired a negative condition.

1236. This effect was at once distinguished from that produced by the excited stem acting in curved lines of induction (1203. 1232.), by the circumstance that all the returned electricity could be perfectly and instantly discharged. It appeared to depend upon the shell-lac within, and to be, in some way,

due to electricity evolved from it in consequence of a previous condition into which it had been brought by the charge of the metallic coatings or balls.

1237. To examine this state more accurately, the apparatus, with the hemispherical cup of shell-lac in it, was charged for about forty-five minutes to above 600° with positive electricity at the balls *h* and B. (fig. 104.) above and within. It was then discharged, opened, the shell-lac taken out, and its state examined; this was done by bringing the carrier ball near the shell-lac, uninsulating it, insulating it, and then observing what charge it had acquired. As it would be a charge by induction, the state of the ball would indicate the opposite state of electricity in that surface of the shell-lac which had produced it. At first the lac appeared quite free from any charge; but gradually its two surfaces assumed opposite states of electricity, the concave surface, which had been next the inner and positive ball, assuming a positive state, and the convex surface, which had been in contact with the negative coating, acquiring a negative state; these states gradually increased in intensity for some time.

1238. As the return action was evidently greatest instantly after the discharge, I again put the apparatus together, and recharged it for fifteen minutes as before, the inner ball positively. I then discharged it, instantly removing the upper hemisphere with the interior ball, and, leaving the shell-lac cup in the lower uninsulated hemisphere, examined its inner surface by the carrier ball as before (1237.). In this way I found the surface of the shell-lac actually *negative*, or in the reverse state to the ball which had been in it; this state quickly disappeared, and was succeeded by a positive condition, gradually increasing in intensity for some time, in the same manner as before. The first negative condition of the surface opposite the positive charging ball is a natural consequence of the state of things, the charging ball being in contact with the shell-lac only in a few points. It does not interfere with the general result and peculiar state now under consideration, except that it assists in illustrating in a very marked manner the ultimate assumption by the surfaces of the shell-lac of an electrified condition, similar to that of the metallic surfaces opposed to or against them.

1239. *Glass* was then examined with respect to its power of assuming this peculiar state. I had a thick flint-glass hemispherical cup formed, which would fit easily into the space *o* of the lower hemisphere (1188. 1189.) ; it had been heated and varnished with a solution of shell-lac in alcohol, for the purpose of destroying the conducting power of the vitreous surface (1254.). Being then well warmed and experimented with, I found it could also assume the *same state*, but not apparently to the same degree, the return action amounting in different cases to quantities from 6° to 18° .

1240. *Spermaceti* experimented with in the same manner gave striking results. When the original charge had been sustained for fifteen or twenty minutes at about 500° , the return charge was equal to 95° or 100° , and was about fourteen minutes arriving at the maximum effect. A charge continued for not more than two or three seconds was here succeeded by a return charge of 50° or 60° . The observations formerly made (1234.) held good with this substance. *Spermaceti*, though it will insulate a low charge for some time, is a better conductor than shell-lac, glass, and sulphur; and this conducting power is connected with the readiness with which it exhibits the particular effect under consideration.

1241. *Sulphur*.—I was anxious to obtain the amount of effect with this substance, first, because it is an excellent insulator, and in that respect would illustrate the relation of the effect to the degree of conducting power possessed by the dielectric (1247.); and in the next place, that I might obtain that body giving the smallest degree of the effect now under consideration, for the investigation of the question of specific inductive capacity (1277.).

1242. With a good hemispherical cup of sulphur cast solid and sound, I obtained the return charge, but only to an amount of 17° or 18° . Thus glass and sulphur, which are bodily very bad conductors of electricity, and indeed almost perfect insulators, gave very little of this return charge.

1243. I tried the same experiment having *air* only in the inductive apparatus. After a continued high charge for some time I could obtain a little effect of return action, but it was ultimately traced to the shell-lac of the stem.

1244. I sought to produce something like this state with one

electric power and without induction; for upon the theory of an electric fluid or fluids, that did not seem impossible, and then I should have obtained an absolute charge (1169. 1177.), or something equivalent to it. In this I could not succeed. I excited the outside of a cylinder of shell-lac very highly for some time, and then quickly discharging it (1203.), waited and watched whether any return charge would appear, but such was not the case. This is another fact in favour of the inseparability of the two electric forces (1177.), and another argument for the view that induction and its concomitant phenomena depend upon a polarity of the particles of matter.

1245. Although inclined at first to refer these effects to a peculiar masked condition of a certain portion of the forces, I think I have since correctly traced them to known principles of electrical action. The effects appear to be due to an actual penetration of the charge to some distance within the electric, at each of its two surfaces, by what we call *conduction*; so that, to use the ordinary phrase, the electric forces sustaining the induction are not upon the metallic surfaces only, but upon and within the dielectric also, extending to a greater or smaller depth from the metal linings. Let c (fig. 113.) be the section of a plate of any dielectric, a and b being the metallic coatings; let b be uninsulated, and a be charged positively; after ten or fifteen minutes, if a and b be discharged, insulated, and immediately examined, no electricity will appear in them; but in a short time, upon a second examination, they will appear charged in the same way, though not to the same degree, as they were at first. Now suppose that a portion of the positive force has, under the coercing influence of all the forces concerned, penetrated the dielectric and taken up its place at the line p , a corresponding portion of the negative force having also assumed its position at the line n ; that in fact the electric at these two parts has become charged positive and negative; then it is clear that the induction of these two forces will be much greater one towards the other, and less in an external direction, now that they are at the small distance np from each other, than when they were at the larger interval ab . Then let a and b be discharged; the discharge destroys or neutralizes all external induction, and the coatings are therefore found by the carrier ball unelectrified but it also removes almost the whole of the forces by which the

electric charge was driven into the dielectric, and though probably a part of that charge goes forward in its passage and terminates in what we call discharge, the greater portion returns on its course to the surfaces of *c*, and consequently to the conductors *a* and *b*, and constitutes the recharge observed.

1246. The following is the experiment on which I rest for the truth of this view. Two plates of spermaceti, *d* and *f* (fig. 114.), were put together to form the dielectric, *a* and *b* being the metallic coatings of this compound plate, as before. The system was charged, then discharged, insulated, examined, and found to give no indications of electricity to the carrier ball. The plates *d* and *f* were then separated from each other, and instantly *a* with *d* was found in a positive state, and *b* with *f* in a negative state, nearly all the electricity being in the linings *a* and *b*. Hence it is clear that, of the forces sought for, the positive was in one half of the compound plate and the negative in the other half; for when removed bodily with the plates from each other's inductive influence, they appeared in separate places, and resumed of necessity their power of acting by induction on the electricity of surrounding bodies. Had the effect depended upon a peculiar relation of the contiguous particles of matter only, then each half plate, *d* and *f*, should have shown positive force on one surface and negative on the other.

1247. Thus it would appear that the best solid insulators, such as shell-lac, glass and sulphur, have conductive properties to such an extent, that electricity can penetrate them bodily, though always subject to the overruling condition of induction (1178.). As to the depth to which the forces penetrate in this form of charge of the particles, theoretically, it should be throughout the mass, for what the charge of the metal does for the portion of dielectric next to it, should be done by the charged dielectric for the portion next beyond it again; but probably in the best insulators the sensible charge is to a very small depth only in the dielectric, for otherwise more would disappear in the first instance whilst the original charge is sustained, less time would be required for the assumption of the particular state, and more electricity would re-appear as return charge.

1248. The condition of *time* required for this penetration of the charge is important, both as respects the general relation

of the eases to conduction, and also the removal of an objection that might otherwise properly be raised to certain results respecting specific inductive capacities, hereafter to be given (1269. 1277.).

1249. It is the assumption for a time of this charged state of the glass between the coatings in the Leyden jar, which gives origin to a well-known phenomenon, usually referred to the diffusion of electricity over the uncoated portion of the glass, namely, the *residual charge*. The extent of charge which can spontaneously be recovered by a large battery, after perfect uninsulation of both surfaces, is very considerable, and by far the largest portion of this is due to the return of electricity in the manner described. A plate of shell-lae six inches square, and half an inch thick, or a similar plate of spermaeeti an inch thick, being coated on the sides with tinfoil as a Leyden arrangement, will show this effect exceedingly well.

1250. The peculiar condition of dielectrics which has now been described, is evidently capable of producing an effect interfering with the results and conclusions drawn from the use of the two inductive apparatus, when shell-lae, glass, &c. is used in one or both of them (1192. 1207.); for upon dividing the charge in such cases according to the method described (1198. 1207.), it is evident that the apparatus just receiving its half charge must fall faster in its tension than the other. For suppose app. i. first charged, and app. ii. used to divide with it; though both may actually lose alike, yet app. i., which has been diminished one half, will be sustained by a certain degree of return action or charge (1234.), whilst app. ii. will sink the more rapidly from the coming on of the particular state. I have endeavoured to avoid this interference by performing the whole process of comparison as quickly as possible, and taking the force of app. ii. immediately after the division, before any sensible diminution of the tension arising from the assumption of the peculiar state could be produced; and I have assumed that as about three minutes pass between the first charge of app. i. and the division, and three minutes between the division and discharge, when the force of the non-transferable electricity is measured, the contrary tendencies for those periods would keep

that apparatus in a moderately steady and uniform condition for the latter portion of time.

1251. The particular action described occurs in the shell-lac of the stems, as well as in the *dielectric* used within the apparatus. It therefore constitutes a cause by which the outside of the stems may in some operations become charged with electricity, independent of the action of dust or carrying particles (1203.).

¶ v. *On specific induction, or specific inductive capacity.*

1252. I now proceed to examine the great question of specific inductive capacity, *i. e.* whether different dielectric bodies actually do possess any influence over the degree of induction which takes place through them. If any such difference should exist, it appeared to me not only of high importance in the further comprehension of the laws and results of induction, but an additional and very powerful argument for the theory I have ventured to put forth, that the whole depends upon a molecular action, in contradistinction to one at sensible distances.

The question may be stated thus: suppose A an electrified plate of metal suspended in the air, and B and C two exactly similar plates, placed parallel to and on each side of A at equal distances and uninsulated; A will then induce equally towards B and C. If in this position of the plates some other dielectric than air, as shell-lac, be introduced between A and C, will the induction between them remain the same? Will the relation of C and B to A be unaltered, notwithstanding the difference of the dielectrics interposed between them?*

1253. As far as I recollect, it is assumed that no change will occur under such variation of circumstances, and that the relations of B and C to A depend entirely upon their distance. I only remember one experimental illustration of the question, and that is by Coulomb †, in which he shows that a wire surrounded by shell-lac took exactly the same quantity of electricity from a charged body as the same wire in air. The ex-

* Refer for the practical illustration of this statement to the supplementary note commencing 1307, &c.—*Dec.* 1838.

† Mémoires de l'Académie, 1787, pp. 452, 453.

periment offered to me no proof of the truth of the supposition : for it is not the mere films of dielectric substances surrounding the charged body which have to be examined and compared, but the *whole mass* between that body and the surrounding conductors at which the induction terminates. Charge depends upon induction (1171. 1178.) ; and if induction is related to the particles of the surrounding dielectric, then it is related to *all* the particles of that dielectric inclosed by the surrounding conductors, and not merely to the few situated next to the charged body. Whether the difference I sought for existed or not, I soon found reason to doubt the conclusion that might be drawn from Coulomb's result ; and therefore had the apparatus made, which, with its use, has been already described (1187, &c.), and which appears to me well suited for the investigation of the question.

1254. Glass, and many bodies which might at first be considered as very fit to test the principle, proved exceedingly unfit for that purpose. Glass, principally in consequence of the alkali it contains, however well warmed and dried it may be, has a certain degree of conducting power upon its surface, dependent upon the moisture of the atmosphere, which renders it unfit for a test experiment. Resin, wax, naphtha, oil of turpentine, and many other substances were in turn rejected, because of a slight degree of conducting power possessed by them ; and ultimately shell-lac and sulphur were chosen, after many experiments, as the dielectrics best fitted for the investigation. No difficulty can arise in perceiving how the possession of a feeble degree of conducting power tends to make a body produce effects, which would seem to indicate that it had a greater capability of allowing induction through it than another body perfect in its insulation. This source of error has been that which I have found most difficult to obviate in the proving experiments.

1255. *Induction through shell-lac.*—As a preparatory experiment, I first ascertained generally that when a part of the surface of a thick plate of shell-lac was excited or charged, there was no sensible difference in the character of the induction sustained by that charged part, whether exerted through

the air in the one direction, or through the shell-lac of the plate in the other; provided the second surface of the plate had not, by contact with conductors, the action of dust, or any other means, become charged (1203.). Its solid condition enabled it to retain the excited particles in a permanent position, but that appeared to be all; for these particles acted just as freely through the shell-lac on one side as through the air on the other. The same general experiment was made by attaching a disc of tinfoil to one side of the shell-lac plate, and electrifying it, and the results were the same. Scarcely any other solid substance than shell-lac and sulphur, and no liquid substance that I have tried will bear this examination. Glass in its ordinary state utterly fails; yet it was essentially necessary to obtain this prior degree of perfection in the dielectric used, before any further progress could be made in the principal investigation.

1256. *Shell-lac and air* were compared in the first place. For this purpose a thick hemispherical cup of shell-lac was introduced into the lower hemisphere of one of the inductive apparatus (1187, &c.), so as nearly to fill the lower half of the space *o, o* (fig. 104.) between it and the inner ball; and then charges were divided in the manner already described (1198. 1207.), each apparatus being used in turn to receive the first charge before its division by the other. As the apparatus were known to have equal inductive power when air was in both (1209. 1211.), any differences resulting from the introduction of the shell-lac would show a peculiar action in it, and if unequivocally referable to a specific inductive influence, would establish the point sought to be sustained. I have already referred to the precautions necessary in making the experiments (1199. &c.); and with respect to the error which might be introduced by the assumption of the peculiar state, it was guarded against, as far as possible, in the first place, by operating quickly (1248); and, afterwards, by using that dielectric as glass or sulphur, which assumed the peculiar state most slowly, and in the least degree (1239. 1241.).

1257. The shell-lac hemisphere was put into app. i., and app. ii. left filled with air. The results of an experiment in which the charge through air was divided and reduced by the shell-lac app. were as follows:

App. i. Lac.	App. ii. Air.
Balls 255°.	
0°	
. . . .	304°
. . . .	297
Charge divided.	
113	
. . . .	121
0	after being discharged.
. . . .	7 after being discharged.

1258. Here 297°, minus 7°, or 290°, may be taken as the divisible charge of app. ii. (the 7° being fixed stem action (1203. 1232.)), of which 145° is the half. The lac. app. i. gave 113° as the power or tension it had acquired after division; and the air app. ii. gave 121°, minus 7°, or 114°, as the force it possessed from what it retained of the divisible charge of 290°. These two numbers should evidently be alike, and they are very nearly so, indeed far within the errors of experiment and observation. But these numbers differ very much from 145°, or the force which the half charge would have had if app. i. had contained air instead of shell-lac; and it appears that whilst in the division the induction through the air has lost 176° of force, that through the lac has only gained 113°.

1259. If this difference be assumed as depending entirely on the greater facility possessed by shell-lac of allowing or causing inductive action through its substance than that possessed by air, then this capacity for electric induction would be inversely as the respective loss and gain indicated above; and assuming the capacity of the air apparatus as 1, that of the shell-lac apparatus would be $\frac{176}{113}$ or 1.55.

1260. This extraordinary difference was so unexpected in its amount, as to excite the greatest suspicion of the general accuracy of the experiment, though the perfect discharge of app. i. after the division, showed that the 113° had been taken and given up readily. It was evident that, if it really existed, it ought to produce corresponding effects in the reverse order; and that when induction through shell-lac was converted into induction through air, the force or tension of the whole ought to be *increased*. The app. i. was therefore charged in the first

place, and its force divided with app. ii. The following were the results :

App. i. Lac.	App. ii. Air.
.	0°
215°	
204	
Charge divided.	
.	118
118	
.	0 after being discharged.
0	after being discharged.

1261. Here 204° must be the utmost of the divisible charge. The app. i. and app. ii. present 118° as their respective forces ; both now much *above* the half of the first force, or 102°, whereas in the former case they were below it. The lac app. i. has lost only 86°, yet it has given to the air app. ii. 118°, so that the lac still appears much to surpass the air, the capacity of the lac app. i. to the air app. ii. being as 1·37 to 1.

1262. The difference of 1·55 and 1·37 as the expression of the capacity for the induction of shell-lac seems considerable, but is in reality very admissible under the circumstances, for both are in error in *contrary directions*. Thus in the last experiment the charge fell from 215° to 204° by the joint effects of dissipation and absorption (1192. 1250.), during the time which elapsed in the electrometer operations, between the applications of the carrier ball required to give those two results. Nearly an equal time must have elapsed between the application of the carrier which gave the 204° result, and the division of the charge between the two apparatus ; and as the fall in force progressively decreases in amount (1192.), if in this case it be taken at 6° only, it will reduce the whole transferable charge at the time of division to 198° instead of 204° ; this diminishes the loss of the shell-lac charge to 80° instead of 86° ; and then the expression of specific capacity for it is increased, and, instead of 1·37, is 1·47 times that of air.

1263. Applying the same correction to the former experiment in which air was *first* charged, the result is of the *contrary* kind. No shell-lac hemisphere was then in the apparatus, and therefore the loss would be principally from dissipation, and not

from absorption : hence it would be nearer to the degree of loss shown by the numbers 304° and 297° , and being assumed as 6° would reduce the divisible charge to 284° . In that case the air would have lost 170° , and communicated only 113° to the shell-lae ; and the relative specific capacity of the latter would appear to be 1.50, which is very little indeed removed from 1.47, the expression given by the second experiment when corrected in the same way.

1264. The shell-lae was then removed from app. i. and put into app. ii. and the experiments of division again made. I give the results, because I think the importance of the point justifies and even requires them.

App. i. Air.	App. ii. Lac.
Balls 200° .	
.	0°
286°	
283	
Charge divided.	
.	110
109	
.	0.25 after discharge.
Trace	after discharge.

Here app. i. retained 109° , having lost 174° in communicating 110° to app. ii. ; and the capacity of the air app. is to the lae app., therefore, as 1 to 1.58. If the divided charge be corrected for an assumed loss of only 3° , being the amount of previous loss in the same time, it will make the capacity of the shell-lae app. 1.55 only.

1265. Then app. ii. was recharged, and the charge divided thus :

App. i. Air.	App. ii. Lac.
0°	
.	256°
.	251
Charge divided.	
146	
.	149
a little	after discharge.
.	a little after discharge.

Here app. i. acquired a charge of 146° , while app. ii. lost only 102° in communicating that amount of force; the capacities being, therefore, to each other as 1 to 1.43. If the whole transferable charge be corrected for a loss of 4° previous to division, it gives the expression of 1.49 for the capacity of the shell-lac apparatus.

1266. These four expressions of 1.47, 1.50, 1.55, and 1.49 for the power of the shell-lac apparatus, through the different variations of the experiment, are very near to each other; the average is close upon 1.5, which may hereafter be used as the expression of the result. It is a very important result; and, showing for this particular piece of shell-lac a decided superiority over air in allowing or causing the act of induction, it proved the growing necessity of a more close and rigid examination of the whole question.

1267. The shell-lac was of the best quality, and had been carefully selected and cleaned; but as the action of any conducting particles in it would tend, virtually, to diminish the quantity or thickness of the dielectric used, and produce effects as if the two inducing surfaces of the conductors in that apparatus were nearer together than in the one with air only, I prepared another shell-lac hemisphere, of which the material had been dissolved in strong spirit of wine, the solution filtered, and then carefully evaporated. This is not an easy operation, for it is difficult to drive off the last portions of alcohol without injuring the lac by the heat applied; and unless they be dissipated, the substance left conducts too well to be used in these experiments. I prepared two hemispheres this way, one of them unexceptionable; and with it I repeated the former experiments with all precautions. The results were exactly of the same kind; the following expressions for the capacity of the shell-lac apparatus, whether it were app. i. or ii., being given directly by the experiments, 1.46, 1.50, 1.52, 1.51; the average of these and several others being very nearly 1.5.

1268. As a final check upon the general conclusion, I then actually brought the surfaces of the air apparatus, corresponding to the place of the shell-lac in its apparatus, nearer together, by putting a metallic lining into the lower hemisphere of the one not containing the lac (1213.). The distance of the metal sur-

face from the carrier ball was in this way diminished from 0.62 of an inch to 0.435 of an inch, whilst the interval occupied by the lac in the other apparatus remained 0.62 of an inch as before. Notwithstanding this change, the lac apparatus showed its former superiority; and whether it or the air apparatus was charged first, the capacity of the lac apparatus to the air apparatus was by the experimental results as 1.45 to 1.

1269. From all the experiments I have made, and their constant results, I cannot resist the conclusion that shell-lac does exhibit a case of *specific inductive capacity*. I have tried to check the trials in every way, and if not remove, at least estimate, every source of error. That the final result is not due to common conduction is shown by the capability of the apparatus to retain the communicated charge; that it is not due to the conductive power of inclosed small particles, by which they could acquire a polarized condition as conductors, is shown by the effects of the shell-lac purified by alcohol; and, that it is not due to any influence of the charged state, formerly described (1250.), first absorbing and then evolving electricity, is indicated by the *instantaneous* assumption and discharge of those portions of the power which are concerned in the phenomena, that instantaneous effect occurring in these cases, as in all others of ordinary induction by charged conductors. The latter argument is the more striking in the case where the air apparatus is employed to divide the charge with the lac apparatus, for it obtains its portion of electricity in an *instant*, and yet is charged far above the *mean*.

1270. Admitting for the present the general fact sought to be proved; then 1.5, though it expresses the capacity of the apparatus containing the hemisphere of shell-lac, by no means expresses the relation of lac to air. The lac only occupies one half of the space *o, o*, of the apparatus containing it, through which the induction is sustained; the rest is filled with air, as in the other apparatus; and if the effect of the two upper halves of the globes be abstracted, then the comparison of the shell-lac powers in the lower half of the one, with the power of the air in the lower half of the other, will be as 2: 1; and even this must be less than the truth, for the induction of the upper part of the apparatus, *i. e.* of the wire and ball B. (fig. 104.) to

external objects, must be the same in both, and considerably diminish the difference dependent upon, and really producible by, the influence of the shell-lac within.

1271. *Glass.*—I next worked with glass at the dielectric. It involved the possibility of conduction on its surface, but it excluded the idea of conducting particles within its substance (1267.) other than those of its own mass. Besides this it does not assume the charged state (1239.) so readily, or to such an extent as shell-lac.

1272. A thin hemispherical cup of glass being made hot was covered with a coat of shell-lac dissolved in alcohol, and after being dried for many hours in a hot place, was put into the apparatus and experimented with. It exhibited effects so slight, that, though they were in the direction indicating a superiority of glass over air, they were allowed to pass as possible errors of experiment; and the glass was considered as producing no sensible effect.

1273. I then procured a thick hemispherical flint glass cup resembling that of shell-lac (1239.), but not filling up the space *o, o*, so well. Its average thickness was 0.4 of an inch, there being an additional thickness of air, averaging 0.22 of an inch to make up the whole space of 0.62 of an inch between the inductive metallic surfaces. It was covered with a film of shell-lac as the former was, (1272.) and being made very warm, was introduced into the apparatus, also warmed, and experiments made with it as in the former instances (1257. &c.). The general results were the same as with shell-lac, *i. e.* glass surpassed air in its power of favouring induction through it. The two best results as respected the state of the apparatus for retention of charge, &c., gave, when the air apparatus was charged first 1.336, and when the glass apparatus was charged first 1.45, as the specific inductive capacity for glass, both being without correction. The average of nine results, four with the glass apparatus first charged, and five with the air apparatus first charged, gave 1.38 as the power of the glass apparatus; 1.22 and 1.46 being the minimum and maximum numbers with all the errors of experiment upon them. In all the experiments the glass apparatus took up its inductive charge instantly, and lost it as readily (1269.); and during the short

time of each experiment, acquired the peculiar state in a small degree only, so that the influence of this state, and also of conduction upon the results, must have been small.

1274. Allowing specific inductive capacity to be proved and active in this case, and 1.38 as the expression for the glass apparatus, then the specific inductive capacity of flint glass will be above 1.76, not forgetting that this expression is for a piece of glass of such thickness as to occupy not quite two-thirds of the space through which the induction is sustained (1273. 1253.).

1275. *Sulphur*.—The same hemisphere of this substance was used in app. ii. as was formerly referred to (1242.). The experiments were well made, *i. e.* the sulphur itself was free from charge both before and after each experiment, and no action from the stem appeared (1203. 1232.), so that no correction was required on that account. The following are the results when the air apparatus was first charged and divided :

App. i. Air.	App. ii. Sulphur.
Balls 280°.	
0°	
. . . .	0°
438	
434	
Charge divided.	
. . . .	162
164	
. . . .	160
162	
. . . .	0 after discharge.
0	after discharge.

Here app. i. retained 164°, having lost 270° in communicating 162° to app. ii., and the capacity of the air apparatus is to that of the sulphur apparatus as 1 to 1.66.

1276. Then the sulphur apparatus was charged first, thus :

. . . .	0°
0°	
. . . .	395
. . . .	388

Charge divided.

237	
	238
0	after discharge.
	0 after discharge.

Here app. ii. retained 238° , and gave up 150° in communicating a charge of 237° to app. i., and the capacity of the air apparatus is to that of the sulphur apparatus as 1 to 1.58. These results are very near to each other, and we may take the mean 1.62 as representing the specific inductive capacity of the sulphur apparatus: in which case the specific inductive capacity of sulphur itself as compared to air = 1 (1270.) will be about or above 2.24.

1277. This result with sulphur I consider as one of the most unexceptionable. The substance when fused was perfectly clear, pellucid, and free from particles of dirt (1267.), so that no interference of small conducting bodies confused the result. The substance when solid is an excellent insulator, and by experiment was found to take up, with great slowness, that state (1241. 1242.) which alone seemed likely to disturb the conclusion. The experiments themselves, also, were free from any need of correction. Yet notwithstanding these circumstances, so favourable to the exclusion of error, the result is a higher specific inductive capacity for sulphur than for any other body as yet tried; and though this may in part be due to the sulphur being in a better shape, *i. e.* filling up more completely the space *o, o*, (fig. 104.) than the cups of shell-lac and glass, still I feel satisfied that the experiments altogether fully prove the existence of a difference between dielectrics as to their power of favouring an inductive action through them; which difference may, for the present, be expressed by the term *specific inductive capacity*.

1278. Having thus established the point in the most favourable cases that I could anticipate, I proceeded to examine other bodies amongst solids, liquids, and gases. These results I shall give with all convenient brevity.

1279. *Spermaceti*.—A good hemisphere of spermaceti being tried as to conducting power whilst its two surfaces were still in contact with the tinfoil moulds used in forming it, was

found to conduct sensibly even whilst warm. On removing it from the moulds and using it in one of the apparatus, it gave results indicating a specific inductive capacity between 1.3 and 1.6 for the apparatus containing it. . But as the only mode of operation was to charge the air apparatus, and then after a quick contact with the spermaceti apparatus, ascertain what was left in the former (1281.), no great confidence can be placed in the results. They are not in opposition to the general conclusion, but cannot be brought forward as argument in favour of it.

1280. I endeavoured to find some liquids which would insulate well, and could be obtained in sufficient quantity for these experiments. Oil of turpentine, native naphtha rectified, and the condensed oil gas fluid, appeared by common experiments to promise best as to insulation. Being left in contact with fused carbonate of potassa, chloride of lime, and quick lime for some days and then filtered, they were found much injured in insulating power; but after distillation acquired their best state, though even then they proved to be conductors when extensive metallic contact was made with them.

1281. *Oil of turpentine rectified.*—I filled the lower half of app. i. with the fluid: and as it would not hold a charge sufficiently to enable me first to measure and then divide it, I charged app. ii. containing air, and dividing its charge with app. i. by a quick contact, measured that remaining in app. ii.: for, theoretically, if a quick contact would divide up to equal tension between the two apparatus, yet without sensible loss from the conducting power of app. i.; and app. ii. were left charged to a degree of tension above half the original charge, it would indicate that oil of turpentine had less specific inductive capacity than air; or, if left charged below that mean state of tension, it would imply that the fluid had the greater inductive capacity. In an experiment of this kind, app. ii. gave as its charge 390° before division with app. i., and 175° afterwards, which is less than the half of 390° . Again, being at 175° before division, it was 79° after, which is also less than half the divided charge. Being at 79° , it was a third time divided, and then fell to 36° , less than the half of 79° . Such are the best results I could obtain; they are not inconsistent with the belief that oil of turpentine has a greater specific

capacity than air, but they do not prove the fact, since the disappearance of more than half the charge may be due to the conducting power merely of the fluid.

1282. *Naphtha*.—This liquid gave results similar in their nature and direction to those with oil of turpentine.

1283. A most interesting class of substances, in relation to specific inductive capacity, now came under review, namely, the gases or aeriform bodies. These are so peculiarly constituted, and are bound together by so many striking physical and chemical relations, that I expected some remarkable results from them: air in various states was selected for the first experiments.

1284. *Air, rare and dense*.—Some experiments of division (1208.) seemed to show that dense and rare air were alike in the property under examination. A simple and better process was to attach one of the apparatus to an air pump, to charge it, and then examine the tension of the charge when the air within was more or less rarefied. Under these circumstances it was found, that commencing with a certain charge, that charge did not change in its tension or force as the air was rarefied, until the rarefaction was such that *discharge* across the space *o, o* (fig. 104.) occurred. This discharge was proportionate to the rarefaction; but having taken place, and lowered the tension to a certain degree, that degree was not at all affected by restoring the pressure and density of the air to their first quantities.

inches of mercury.

Thus at a pressure of	30	the charge was	. . .	88°
Again	30	the charge was	. . .	88
Again	30	the charge was	. . .	87
Reduced to	14	the charge was	. . .	87
Raised again to . . .	30	the charge was	. . .	86
Being now reduced to	3.4	the charge fell to.	. . .	81
Raised again to . . .	30	the charge was still	. . .	81

1285. The charges were low in these experiments, first that they might not pass off at low pressure, and next that little loss by dissipation might occur. I now reduced them still lower, that I might rarefy further, and for this purpose in the

following experiment used a measuring interval in the electrometer of only 15° (1185.). The pressure of air within the apparatus being reduced to 1.9 inches of mercury, the charge was found to be 29° ; then letting in air till the pressure was 30 inches, the charge was still 29° .

1286. These experiments were repeated with pure oxygen with the same consequences.

1287. This result of *no variation* in the electric tension being produced by variation in the density or pressure of the air agrees perfectly with those obtained by Mr. Harris*, and described in his beautiful and important investigations contained in the Philosophical Transactions; namely that induction is the same in rare and dense air, and that the divergence of an electrometer under such variations of the air continues the same, provided no electricity pass away from it. The effect is one entirely independent of that power which dense air has of causing a higher charge to be *retained* upon the surface of conductors in it than can be retained by the same conductors in rare air; a point I propose considering hereafter.

1288. I then compared *hot and cold air* together, by raising the temperature of one of the inductive apparatus as high as it could be without injury, and then dividing charges between it and the other apparatus containing cold air. The temperatures were about 50° and 200° . Still the power or capacity appeared to be unchanged; and when I endeavoured to vary the experiment, by charging a cold apparatus and then warming it by a spirit lamp, I could obtain no proof that the inductive capacity underwent any alteration.

1289. I compared *damp and dry air* together, but could find no difference in the results.

1290. *Gases*.—A very long series of experiments was then undertaken for the purpose of comparing *different gases* one with another. They were all found to insulate well, except such as acted on the shell-lac of the supporting stem; these were chlorine, ammonia, and muriatic acid. They were all dried by appropriate means before being introduced into the apparatus. It would have been sufficient to have compared each with air; but, in consequence of the striking result which came out,

* Philosophical Transactions, 1834, pp. 223, 224, 237, 244.

namely, that *all had the same power of or capacity for*, sustaining induction through them, (which perhaps might have been expected after it was found that no variation of density or pressure produced any effect,) I was induced to compare them, experimentally, two and two in various ways, that no difference might escape me, and that the sameness of result might stand in full opposition to the contrast of property, composition, and condition which the gases themselves presented.

1291. The experiments were made upon the following pairs of gases.

1. Nitrogen and . . . Oxygen.
2. Oxygen Air.
3. Hydrogen Air.
4. Muriatic acid gas . Air.
5. Oxygen Hydrogen.
6. Oxygen Carbonic acid.
7. Oxygen Olefiant gas.
8. Oxygen Nitrous gas.
9. Oxygen Sulphurous acid.
10. Oxygen Ammonia.
11. Hydrogen Carbonic acid.
12. Hydrogen Olefiant gas.
13. Hydrogen Sulphurous acid.
14. Hydrogen Fluo-silicic acid.
15. Hydrogen Ammonia.
16. Hydrogen Arseniuretted hydrogen.
17. Hydrogen Sulphuretted hydrogen.
18. Nitrogen Olefiant gas.
19. Nitrogen Nitrous gas.
20. Nitrogen Nitrous oxide.
21. Nitrogen Ammonia.
22. Carbonic oxide . . Carbonic acid.
23. Carbonic oxide . . Olefiant gas.
24. Nitrous oxide . . Nitrous gas.
25. Ammonia Sulphurous acid.

1292. Notwithstanding the striking contrasts of all kinds which these gases present of property, of density, whether simple or compound, anions or cations (665.), of high or low pressure (1284. 1286.), hot or cold (1288.), not the least differ-

ence in their capacity to favour or admit electrical induction through them could be perceived. Considering the point established, that in all these gases induction takes place by an action of contiguous particles, this is the more important, and adds one to the many striking relations which hold between bodies having the gaseous condition and form. Another equally important electrical relation, which will be examined in the next paper*, is that which the different gases have to each other at the *same pressure* of causing the retention of the *same or different degrees of charge* upon conductors in them. These two results appear to bear importantly upon the subject of electrochemical excitation and decomposition; for as *all* these phenomena, different as they seem to be, must depend upon the electrical forces of the particles of matter, the very distance at which they seem to stand from each other will do much, if properly considered, to illustrate the principle by which they are held in one common bond, and subject, as they must be, to one common law.

1293. It is just possible that the gases may differ from each other in their specific inductive capacity, and yet by quantities so small as not to be distinguished in the apparatus I have used. It must be remembered, however, that in the gaseous experiments the gases occupy all the space *o, o*, (fig. 104.) between the inner and the outer ball, except the small portion filled by the stem; and the results, therefore, are twice as delicate as those with solid dielectrics.

1294. The insulation was good in all the experiments recorded, except Nos. 10, 15, 21, and 25, being those in which ammonia was compared with other gases. When shell-lac is put into ammoniacal gas its surface gradually acquires conducting power, and in this way the lac part of the stem within was so altered, that the ammonia apparatus could not retain a charge with sufficient steadiness to allow of division. In these experiments, therefore, the other apparatus was charged; its charge measured and divided with the ammonia apparatus by a quick contact, and what remained untaken away by the division again measured (1281.). It was so nearly one half of the original charge, as to authorize, with this reservation, the insertion of

* See in relation to this point 1382, &c.—Dec. 1838.

ammoniacal gas amongst the other gases, as having equal power with them.

¶ vi. *General results as to induction.*

1295. Thus *induction* appears to be essentially an action of contiguous partieles, through the intermediation of which the electric force, originating or appearing at a certain place, is propagated to or sustained at a distance, appearing there as a force of the same kind exactly equal in amount, but opposite in its direction and tendencies (1164.). Induction requires no sensible thickness in the conductors which may be used to limit its extent; an uninsulated leaf of gold may be made very highly positive on one surface, and as highly negative on the other, without the least interference of the two states whilst the inductions continue. Nor is it affected by the nature of the limiting conductors, provided time be allowed, in the case of those which conduct slowly, for them to assume their final state (1170.).

1296. But with regard to the *dielectrics* or insulating media, matters are very different (1167.). Their thickness has an immediate and important influence on the degree of induction. As to their quality, though all gases and vapours are alike, whatever their state; yet amongst solid bodies, and between them and gases, there are differences which prove the existence of *specific inductive capacities*, these differences being in some cases very great.

1297. The direct inductive force, which may be conceived to be exerted in lines between the two limiting and charged conducting surfaces, is accompanied by a lateral or transverse force equivalent to a dilatation or repulsion of these representative lines (1224.); or the attractive force which exists amongst the partieles of the dielectric in the direction of the induction is accompanied by a repulsive or a diverging force in the transverse direction (1304.).

1298. Induction appears to consist in a certain polarized state of the partieles, into which they are thrown by the electrified body sustaining the action, the partieles assuming positive and negative points or parts, which are symmetrically arranged with respect to each other and the inducing surfaces or partieles*.

* The theory of induction which I am stating does not pretend to decide

The state must be a forced one, for it is originated and sustained only by force, and sinks to the normal or quiescent state when that force is removed. It can be *continued* only in insulators by the same portion of electricity, because they only can retain this state of the particles (1304.).

1299. The principle of induction is of the utmost generality in electric action. It constitutes charge in every ordinary case, and probably in every case; it appears to be the cause of all excitement, and to precede every current. The degree to which the particles are affected in this their forced state, before discharge of one kind or another supervenes, appears to constitute what we call *intensity*.

1300. When a Leyden jar is *charged*, the particles of the glass are forced into this polarized and constrained condition by the electricity of the charging apparatus. *Discharge* is the return of these particles to their natural state from their state of tension, whenever the two electric forces are allowed to be disposed of in some other direction.

1301. All charge of conductors is on their surface, because being essentially inductive, it is there only that the medium capable of sustaining the necessary inductive state begins. If the conductors are hollow and contain air or any other dielectric, still no *charge* can appear upon that internal surface, because the dielectric there cannot assume the polarized state throughout, in consequence of the opposing actions in different directions.

1302. The known influence of *form* is perfectly consistent with the corpuscular view of induction set forth. An electrified cylinder is more affected by the influence of the surrounding conductors (which complete the condition of charge) at the ends than at the middle, because the ends are exposed to a greater sum of inductive forces than the middle; and a point is brought to a higher condition than a ball, because by relation to the conductors around, more inductive force terminates on its surface than on an equal surface of the ball with which it is compared. Here, too, especially, can be perceived the influence of the lateral or transverse force (1297.), which, being

whether electricity be a fluid or fluids, or a mere power or condition of recognized matter. That is a question which I may be induced to consider in the next or following series of these researches.

a power of the nature of or equivalent to repulsion, causes such a disposition of the lines of inductive force in their course across the dielectric, that they must accumulate upon the point, the end of the cylinder, or any projecting part.

1303. The influence of *distance* is also in harmony with the same view. There is perhaps no distance so great that induction cannot take place through it*; but with the same constraining force (1298.) it takes place the more easily, according as the extent of dielectric through which it is exerted is lessened. And as it is assumed by the theory that the particles of the dielectric, though tending to remain in a normal state, are thrown into a forced condition during the induction; so it would seem to follow that the fewer there are of these intervening particles opposing their tendency to the assumption of the new state, the greater degree of change will they suffer, *i. e.* the higher will be the condition they assume, and the larger the amount of inductive action exerted through them.

1304. I have used the phrases *lines of inductive force* and *curved lines* of force (1231. 1297. 1298. 1302.) in a general sense only, just as we speak of the lines of magnetic force. The lines are imaginary, and the force in any part of them is of course the resultant of compound forces, every molecule being related to every other molecule in *all* directions by the tension and reaction of those which are contiguous. The transverse force is merely this relation considered in a direction oblique to the lines of inductive force, and at present I mean no more than that by the phrase. With respect to the term *polarity* also, I mean at present only a disposition of force by which the same molecule acquires opposite powers on different parts. The particular way in which this disposition is made will come into consideration hereafter, and probably varies in different bodies, and so produces variety of electrical relation†. All I am anxious about at present is, that a more particular meaning should not be attached to the expressions used

* I have traced it experimentally from a ball placed in the middle of the large cube formerly described (1173.) to the sides of the cube six feet distant, and also from the same ball placed in the middle of our large lecture-room to the walls of the room at twenty-six feet distance, the charge sustained upon the ball in these cases being solely due to induction through these distances.

† See now 1685. &c.—Dec. 1838.

than I contemplate. Further inquiry, I trust, will enable us by degrees to restrict the sense more and more, and so render the explanation of electrical phenomena day by day more and more definite.

1305. As a test of the probable accuracy of my views, I have throughout this experimental examination compared them with the conclusions drawn by M. Poisson from his beautiful mathematical inquiries*. I am quite unfit to form a judgment of these admirable papers; but as far as I can perceive, the theory I have set forth and the results I have obtained are not in opposition to such of those conclusions as represent the final disposition and state of the forces in the limited number of cases he has considered. His theory assumes a very different mode of action in induction to that which I have ventured to support, and would probably find its mathematical test in the endeavour to apply it to cases of induction in curved lines. To my feeling it is insufficient in accounting for the retention of electricity upon the surface of conductors by the pressure of the air, an effect which I hope to show is simple and consistent according to the present view†; and it does not touch voltaic electricity, or in any way associate it and what is called ordinary electricity under one common principle.

I have also looked with some anxiety to the results which that indefatigable philosopher Harris has obtained in his investigation of the laws of induction‡, knowing that they were experimental, and having a full conviction of their exactness; but I am happy in perceiving no collision at present between them and the views I have taken.

1306. Finally, I beg to say that I put forth my particular view with doubt and fear, lest it should not bear the test of general examination, for unless true it will only embarrass the progress of electrical science. It has long been on my mind, but I hesitated to publish it until the increasing persuasion of its accordance with all known facts, and the manner in which it linked together effects apparently very different in kind,

* Mémoires de l'Institut, 1811, tom. xii. the first page 1, and the second paging 163.

† Refer to 1377, 1378, 1379, 1398.—Dec. 1833.

‡ Philosophical Transactions, 1834, p. 213.

urged me to write the present paper. I as yet see no inconsistency between it and nature, but, on the contrary, think I perceive much new light thrown by it on her operations; and my next papers will be devoted to a review of the phenomena of conduction, electrolyzation, current, magnetism, retention, discharge, and some other points, with an application of the theory to these effects, and an examination of it by them.

Royal Institution,

November 16, 1837.

*Supplementary Note to Experimental Researches in Electricity.
Eleventh Series.*

Received March 29, 1838.

1307. I have recently put into an experimental form that general statement of the question of *specific inductive capacity* which is given at No. 1252 of Series XI., and the result is such as to lead me to hope the Council of the Royal Society will authorize its addition to the paper in the form of a supplementary note. Three circular brass plates, about five inches in diameter, were mounted side by side upon insulating pillars; the middle one, A, was a fixture, but the outer plates B and C were moveable on slides, so that all three could be brought with their sides almost into contact, or separated to any required distance. Two gold leaves were suspended in a glass jar from insulated wires; one of the outer plates B was connected with one of the gold leaves, and the other outer plate with the other leaf. The outer plates B and C were adjusted at the distance of an inch and a quarter from the middle plate A, and the gold leaves were fixed at two inches apart; A was then slightly charged with electricity, and the plates B and C, with their gold leaves, thrown out of insulation *at the same time*, and then left insulated. In this state of things A was charged positive inductrially, and B and C negative inducteously; the same dielectric, air, being in the two intervals, and the gold leaves hanging, of course, parallel to each other in a relatively un-electrified state.

1308. A plate of shell-lae three quarters of an inch in thickness, and four inches square, suspended by clean white silk thread, was very carefully deprived of all charge (1203.) (so that it produced no effect on the gold leaves if A were uncharged) and then introduced between plates A and B; the electric relation of the three plates was immediately altered, and the gold leaves attracted each other. On removing the shell-lae this attraction ceased; on introducing it between A and C it was renewed; on removing it the attraction again ceased; and the shell-lae when examined by a delicate Coulomb electrometer was still without charge.

1309. As A was positive, B and C were of course negative; but as the specific inductive capacity of shell-lae is about twice that of air (1270.), it was expected that when the lae was introduced between A and B, A would induce more towards B than towards C; that therefore B would become more negative than before towards A, and, consequently, because of its insulated condition, be positive externally, as at its back or at the gold leaves; whilst C would be less negative towards A, and therefore negative outwards or at the gold leaves. This was found to be the case; for on whichever side of A the shell-lae was introduced the external plate at that side was positive, and the external plate on the other side negative towards each other, and also to uninsulated external bodies.

1310. On employing a plate of sulphur instead of shell-lae, the same results were obtained; consistent with the conclusions drawn regarding the high specific inductive capacity of that body already given (1276.).

1311. These effects of specific inductive capacity can be exalted in various ways, and it is this capability which makes the great value of the apparatus. Thus I introduced the shell-lae between A and B, and then for a moment connected B and C, uninsulated them, and finally left them in the insulated state; the gold leaves were of course hanging parallel to each other. On removing the shell-lae the gold leaves attracted each other; on introducing the shell-lae between A and C this attraction was *increased*, (as had been anticipated from theory,) and the leaves came together, though not more than four inches long, and hanging three inches apart.

1312. By simply bringing the gold leaves nearer to each other

I was able to show the difference of specific inductive capacity when only thin plates of shell-lac were used, the rest of the dielectric space being filled with air. By bringing B and C nearer to A another great increase of sensibility was made. By enlarging the size of the plates still further power was gained. By diminishing the extent of the wires, &c. connected with the gold leaves, another improvement resulted. So that in fact the gold leaves became, in this manner, as delicate a test of *specific inductive action* as they are, in Bennet's and Singer's electrometers, of ordinary electrical charge.

1313. It is evident that by making the three plates the sides of cells, with proper precautions as regards insulation, &c., this apparatus may be used in the examination of gases, with far more effect than the former apparatus (1187. 1290.), and may, perhaps, bring out differences which have as yet escaped me (1292. 1293.).

1314. It is also evident that two metal plates are quite sufficient to form the instrument; the state of the single inductive plate when the dielectric is changed, being examined either by bringing a body excited in a known manner towards its gold leaves, or, what I think will be better, employing a carrier ball in place of the leaf, and examining that ball by the Coulomb electrometer (1180.). The inductive and inductive surfaces may even be balls; the latter being itself the carrier ball of the Coulomb's electrometer (1181. 1229.).

1315. To increase the effect, a small condenser may be used with great advantage. Thus if, when two inductive plates are used, a little condenser were put in the place of the gold leaves, I have no doubt the three principal plates might be reduced to an inch or even half an inch in diameter. Even the gold leaves act to each other for the time as the plates of a condenser. If only two plates were used, by the proper application of the condenser the same reduction might take place. This expectation is fully justified by an effect already observed and described (1229.).

1316. In that case the application of the instrument to very extensive research is evident. Comparatively small masses of dielectrics could be examined, as diamonds and crystals. An expectation, that the specific inductive capacity of crystals will vary in different directions, according as the lines of inductive

forec (1304.) are parallel to, or in other positions in relation to the axes of the crystals, can be tested*: I purpose that these and many other thoughts which arise respecting specific inductive action and the polarity of the particles of dielectric matter, shall be put to the proof as soon as I can find time.

1317. Hoping that this apparatus will form an instrument of considerable use, I beg to propose for it (at the suggestion of a friend) the name of *Differential Inductometer*.

Royal Institution,
March 29, 1838.

* Refer for this investigation to 1689—1698.—*Dec. 1838.*

TWELFTH SERIES.

§ 18. *On Induction (continued).* ¶ vii. *Conduction, or conductive discharge.* ¶ viii. *Electrolytic discharge.* ¶ ix. *Disruptive discharge—Insulation—Spark—Brush—Difference of discharge at the positive and negative surfaces of conductors.*

Received January 11,—Read February 8, 1838.

1318. I PROCEED now, according to my promise, to examine, by the great facts of electrical science, that theory of induction which I have ventured to put forth (1165. 1295. &c.). The principle of induction is so universal that it pervades all electrical phenomena; but the general case which I purpose at present to go into consists of insulation traced into and terminating with discharge, with the accompanying effects. This case includes the various *modes* of discharge, and also the condition and characters of a current; the elements of magnetic action being amongst the latter. I shall necessarily have occasion to speak theoretically, and even hypothetically; and though these papers profess to be experimental researches, I hope that, considering the facts and investigations contained in the last series in support of the particular view advanced, I shall not be considered as taking too much liberty on the present occasion, or as departing too far from the character which they ought to have, especially as I shall use every opportunity which presents itself of returning to that strong test of truth, experiment.

1319. Induction has as yet been considered in these papers only in cases of insulation; opposed to insulation is *discharge*. The action or effect which may be expressed by the general term *discharge*, may take place, as far as we are aware at present, in several modes. Thus, that which is called simply *conduction* involves no chemical action, and apparently no displacement of the particles concerned. A second mode may

be called *electrolytic discharge*; in it chemical action does occur, and particles must, to a certain degree, be displaced. A third mode, namely, that by sparks or brushes, may, because of its violent displacement of the particles of the *dielectric* in its course, be called the *disruptive discharge*; and a fourth may, perhaps, be conveniently distinguished for a time by the words *convection*, or *carrying discharge*, being that in which discharge is effected either by the carrying power of solid particles, or those of gases and liquids. Hereafter, perhaps, all these modes may appear as the result of one common principle, but at present they require to be considered apart; and I will now speak of the *first* mode, for amongst all the forms of discharge that which we express by the term conduction appears the most simple and the most directly in contrast with insulation.

¶ vii. *Conduction, or conductive discharge.*

1320. Though assumed to be essentially different, yet neither Cavendish nor Poisson attempt to explain by, or even state in, their theories, what the essential difference between insulation and conduction is. Nor have I anything, perhaps, to offer in this respect, *except* that, according to my view of induction, insulation and conduction depend upon the same molecular action of the dielectrics concerned; are only extreme degrees of *one common condition* or effect; and in any sufficient mathematical theory of electricity must be taken as cases of the same kind. Hence the importance of the endeavour to show the connection between them under my theory of the electrical relations of contiguous particles.

1321. Though the action of the insulating dielectric in the charged Leyden jar, and that of the wire in discharging it, may seem very different, they may be associated by numerous intermediate links, which carry us on from one to the other, leaving, I think, no necessary connection unsupplied. We may observe some of these in succession for information respecting the whole case.

1322. Spermaeeti has been examined and found to be a dielectric, through which induction can take place (1240. 1246.),

its specific inductive capacity being about or above 1·8 (1279.), and the inductive action has been considered in it, as in all other substances, an action of contiguous particles.

1323. But spermaceti is also a *conductor*, though in so low a degree that we can trace the process of conduction, as it were, step by step through the mass (1247.); and even when the electric force has travelled through it to a certain distance, we can, by removing the coercitive (which is at the same time the inductive) force, cause it to return upon its path and reappear in its first place (1245. 1246.). Here induction appears to be a necessary preliminary to conduction. It of itself brings the contiguous particles of the dielectric into a certain condition, which, if retained by them, constitutes *insulation*, but if lowered by the communication of power from one particle to another, constitutes *conduction*.

1324. If *glass* or *shell-lac* be the substances under consideration, the same capabilities of suffering either induction or conduction through them appear (1233. 1239. 1247.), but not in the same degree. The conduction almost disappears (1239. 1242.); the induction therefore is sustained, *i. e.* the polarized state into which the inductive force has brought the contiguous particles is retained, there being little discharge action between them, and therefore the *insulation* continues. But, what discharge there is, appears to be consequent upon that condition of the particles into which the induction throws them; and thus it is that ordinary insulation and conduction are closely associated together or rather are extreme cases of one common condition.

1325. In ice or water we have a better conductor than spermaceti, and the phenomena of induction and insulation therefore rapidly disappear, because conduction quickly follows upon the assumption of the inductive state. But let a plate of cold ice have metallic coatings on its sides, and connect one of these with a good electrical machine in work, and the other with the ground, and it then becomes easy to observe the phenomena of induction through the ice, by the electrical tension which can be obtained and continued on both the coatings (419. 426.). For although that portion of power which at one moment gave the inductive condition to the particles is at the next lowered by the consequent discharge due to the conductive act, it is

succeeded by another portion of force from the machine to restore the inductive state. If the ice be converted into water the same succession of actions can be just as easily proved, provided the water be distilled, and (if the machine be not powerful enough) a voltaic battery be employed.

1326. All these considerations impress my mind strongly with the conviction, that insulation and ordinary conduction cannot be properly separated when we are examining into their nature; that is, into the general law or laws under which their phenomena are produced. They appear to me to consist in an action of contiguous particles dependent on the forces developed in electrical excitement; these forces bring the particles into a state of tension or polarity, which constitutes both *induction* and *insulation*; and being in this state, the contiguous particles have a power or capability of communicating their forces one to the other, by which they are lowered, and discharge occurs. Every body appears to discharge (444. 987.); but the possession of this capability in a *greater or smaller degree* in different bodies, makes them better or worse conductors, worse or better insulators; and both *induction* and *conduction* appear to be the same in their principle and action (1320.), except that in the latter an effect common to both is raised to the highest degree, whereas in the former it occurs in the best cases, in only an almost insensible quantity.

1327. That in our attempts to penetrate into the nature of electrical action, and to deduce laws more general than those we are at present acquainted with, we should endeavour to bring apparently opposite effects to stand side by side in harmonious arrangement, is an opinion of long standing, and sanctioned by the ablest philosophers. I hope, therefore, I may be excused the attempt to look at the highest cases of conduction as analogous to, or even the same in kind with, those of induction and insulation.

1328. If we consider the slight penetration of sulphur (1241. 1242.) or shell-lac (1234.) by electricity, or the feeble insulation sustained by spermaceti (1279. 1240.), as essential consequences and indications of their *conducting* power, then may we look on the resistance of metallic wires to the passage of electricity through them as *insulating* power. Of the

numerous well-known cases fitted to show this resistance in what are called the perfect conductors, the experiments of Professor Wheatstone best serve my present purpose, since they were carried to such an extent as to show that *time* entered as an element into the conditions of conduction* even in metals. When discharge was made through a copper wire 2640 feet in length, and $\frac{1}{15}$ th of an inch in diameter, so that the luminous sparks at each end of the wire, and at the middle, could be observed in the same place, the latter was found to be sensibly behind the two former in time, they being by the conditions of the experiment simultaneous. Hence a proof of retardation; and what reason can be given why this retardation should not be of the same kind as that in spermaceti, or in lac, or sulphur? But as, in them, retardation is insulation, and insulation is induction, why should we refuse the same relation to the same exhibitions of force in the metals?

1329. We learn from the experiment, that if *time* be allowed the retardation is gradually overcome; and the same thing obtains for the spermaceti, the lac, and glass (1248.); give but time in proportion to the retardation, and the latter is at last vanquished. But if that be the case, and all the results are alike in kind, the only difference being in the length of time, why should we refuse to metals the previous inductive action, which is admitted to occur in the other bodies? The diminution of *time* is no negation of the action; nor is the lower degree of tension requisite to cause the forces to traverse the metal, as compared to that necessary in the cases of water, spermaceti, or lac. These differences would only point to the conclusion, that in metals the particles under induction can transfer their forces when at a lower degree of tension or polarity, and with greater facility than in the instances of the other bodies.

1330. Let us look at Mr. Wheatstone's beautiful experiment in another point of view. If, leaving the arrangement at the middle and two ends of the long copper wire unaltered, we remove the two intervening portions and replace them by wires of iron or platina, we shall have a much greater retardation of the middle spark than before. If, removing the iron,

* Philosophical Transactions, 1834, p. 583.

we were to substitute for it only five or six feet of water in a cylinder of the same diameter as the metal, we should have still greater retardation. If from water we passed to spermaeti, either directly or by gradual steps through other bodies, (even though we might vastly enlarge the bulk, for the purpose of evading the occurrence of a spark elsewhere (1331.) than at the three proper intervals,) we should have still greater retardation, until at last we might arrive, by degrees so small as to be inseparable from each other, at actual and permanent insulation. What, then, is to separate the principle of these two extremes, perfect conduction and perfect insulation, from each other; since the moment we leave in the smallest degree perfection at either extremity, we involve the element of perfection at the opposite end? Especially too, as we have not in nature the case of perfection either at one extremity or the other, either of insulation or conduction.

1331. Again, to return to this beautiful experiment in the various forms which may be given to it: the forces are not all in the wire (after they have left the Leyden jar) during the whole time (1328.) occupied by the discharge; they are disposed in part through the surrounding dielectric under the well-known form of induction; and if that dielectric be air, induction takes place from the wire through the air to surrounding conductors, until the ends of the wire are electrically related through its length, and discharge has occurred, *i. e.* for the *time* during which the middle spark is retarded beyond the others. This is well shown by the old experiment, in which a long wire is so bent that two parts (Plate VIII. fig. 115.) *a. b.* near its extremities shall approach within a short distance, as a quarter of an inch, of each other in the air. If the discharge of a Leyden jar, charged to a sufficient degree, be sent through such a wire, by far the largest portion of the electricity will pass as a spark across the air at the interval, and not by the metal. Does not the middle part of the wire, therefore, act here as an insulating medium, though it be of metal? and is not the spark through the air an indication of the tension (simultaneous with *induction*) of the electricity in the ends of this single wire? Why should not the wire and the air both be regarded as dielectrics; and the action at its commencement, and whilst there is tension, as an inductive action? If it acts through the contorted lines of the wire,

so it also does in curved and contorted lines through air (1219. 1224. 1231.), and other insulating dielectrics (1228.); and we can apparently go so far in the analogy, whilst limiting the case to the inductive action only, as to show that amongst insulating dielectrics some lead away the lines of force from others (1229.), as the wire will do from worse conductors, though in it the principal effect is no doubt due to the ready discharge between the particles whilst in a low state of tension. The retardation is for the time insulation; and it seems to me we may just as fairly compare the air at the interval *a, b.* (fig. 115.) and the wire in the circuit, as two bodies of the same kind and acting upon the same principles, as far as the first inductive phenomena are concerned, notwithstanding the different forms of discharge which ultimately follow*, as we may compare, according to Coulomb's investigations †, *different lengths* of different insulating bodies required to produce the same amount of insulating effect.

1332. This comparison is still more striking when we take into consideration the experiment of Mr. Harris, in which he stretched a fine wire across a glass globe, the air within being rarefied ‡. On sending a charge through the joint arrangement of metal and rare air, as much, if not more, electricity passed by the latter as by the former. In the air, rarefied as it was, there can be no doubt the discharge was preceded by induction (1284.); and to my mind all the circumstances indicate that the same was the case with the metal; that, in fact, both substances are dielectrics, exhibiting the same effects in consequence of the action of the same causes, the only variation being one of degree in the different substances employed.

1333. Judging on these principles, velocity of discharge through the *same wire* may be varied greatly by attending to the circumstances which cause variations of discharge through spermaeti or sulphur. Thus, for instance, it must vary with the tension or intensity of the first urging force (1234. 1240.), which tension is charge and induction. So if the two ends of the wire, in Professor Wheatstone's experiment, were immediately connected with two large insulated metallic surfaces ex-

* These will be examined hereafter (1348, &c.).

† Mémoires de l'Académie, 1785, p. 612. or Ency. Britann. First. Supp. vol. i. p. 611.

‡ Philosophical Transactions, 1834, p. 242.

posed to the air, so that the primary act of induction, after making the contact for discharge, might be in part removed from the internal portion of the wire at the first instant, and disposed for the moment on its surface jointly with the air and surrounding conductors, then I venture to anticipate that the middle spark would be more retarded than before; and if these two plates were the inner and outer coating of a large jar or a Leyden battery, then the retardation of that spark would be still greater.

1334. Cavendish was perhaps the first to show distinctly that discharge was not always by one channel*, but, if several are present, by many at once. We may make these different channels of different bodies, and by proportioning their thicknesses and lengths, may include such substances as air, lac, spermaceti, water, protoxide of iron, iron and silver, and by *one* discharge make each convey its proportion of the electric force. Perhaps the air ought to be excepted, as its discharge by conduction is questionable at present (1336.); but the others may all be limited in their mode of discharge to pure conduction. Yet several of them suffer previous induction, precisely like the induction through the air, it being a necessary preliminary to their discharging action. How can we therefore separate any one of these bodies from the others, as to the *principles and mode* of insulating and conducting, except by mere degree? All seem to me to be dielectrics acting alike, and under the same common laws.

1335. I might draw another argument in favour of the general sameness, in nature and action, of good and bad conductors (and all the bodies I refer to are conductors more or less), from the perfect equipoise in action of very different bodies when opposed to each other in magneto-electric inductive action, as formerly described (213.), but am anxious to be as brief as is consistent with the clear examination of the probable truth of my views.

1336. With regard to the possession by the gases of any conducting power of the simple kind now under consideration, the question is a very difficult one to determine at present. Experiments seem to indicate that they do insulate certain low degrees of tension perfectly, and that the effects which may have appeared to be occasioned by *conduction* have been the

* Philosophical Transactions, 1776, p. 197.

result of the carrying power of the charged particles, either of the air or of dust, in it. It is equally certain, however, that with higher degrees of tension or charge the particles discharge to one another, and that is conduction. If the gases possess the power of insulating a certain low degree of tension continuously and perfectly, such a result may be due to their peculiar physical state, and the condition of separation under which their particles are placed. But in that, or in any case, we must not forget the fine experiments of Cagniard de la Tour*, in which he has shown that liquids and their vapours can be made to pass gradually into each other, to the entire removal of any marked distinction of the two states. Thus, hot dry steam and cold water pass by insensible gradations into each other; yet the one is amongst the gases as an insulator, and the other a comparatively good conductor. As to conducting power, therefore, the transition from metals even up to gases is gradual; substances make but one series in this respect, and the various cases must come under one condition and law (444.). The specific differences of bodies as to conducting power only serves to strengthen the general argument, that conduction, like insulation, is a result of induction, and is an action of contiguous particles.

1337. I might go on now to consider induction and its concomitant, *conduction*, through mixed dielectrics, as, for instance, when a charged body, instead of acting across air to a distant uninsulated conductor, acts jointly through it and an interposed insulated conductor. In such a case, the air and the conducting body are the mixed dielectrics; and the latter assumes a polarized condition as a mass, like that which my theory assumes *each particle* of the air to possess at the same time (1679.). But I fear to be tedious in the present condition of the subject, and hasten to the consideration of other matter.

1338. To sum up, in some degree, what has been said, I look upon the first effect of an excited body upon neighbouring matters to be the production of a polarized state of their particles, which constitutes *induction*; and this arises from its action upon the particles in immediate contact with it, which again act upon those contiguous to them, and thus the forces are transferred to a distance. If the induction remain undiminished, then perfect insulation is the consequence; and the higher the

* *Annales de Chimie*, xxi. pp. 127, 178; or *Quarterly Journal of Science*, xv. 145.

polarized condition which the particles can acquire or maintain, the higher is the intensity which may be given to the acting forces. If, on the contrary, the contiguous particles, upon acquiring the polarized state, have the power to communicate their forces, then conduction occurs, and the tension is lowered, conduction being a distinct act of discharge between neighbouring particles. The lower the state of tension at which this discharge between the particles of a body takes place, the better conductor is that body. In this view, insulators may be said to be bodies whose particles can retain the polarized state; whilst conductors are those whose particles cannot be permanently polarized. If I be right in my view of induction, then I consider the reduction of these two effects (which have been so long held distinct) to an action of contiguous particles obedient to one common law, as a very important result; and, on the other hand, the identity of character which the two acquire when viewed by the theory (1326.), is additional presumptive proof in favour of the correctness of the latter.

1339. That heat has great influence over simple conduction is well known (445.), its effect being, in some cases, almost an entire change of the characters of the body (432. 1340.). Harris has, however, shown that it in no respect affects gaseous bodies, or at least air*; and Davy has taught us that, as a class, metals have their conducting power *diminished* by it†.

1340. I formerly described a substance, sulphuret of silver, whose conducting power was increased by heat (433. 437. 438.); and I have since then met with another as strongly affected in the same way: this is fluoride of lead. When a piece of that substance, which had been fused and cooled, was introduced into the circuit of a voltaic battery, it stopped the current. Being heated, it acquired conducting powers before it was visibly red hot in daylight; and even sparks could be taken against it whilst still solid. The current alone then raised its temperature (as in the case of sulphuret of silver) until it fused, after which it seemed to conduct as well as the metallic vessel containing it; for whether the wire used to complete the circuit touched the fused fluoride only, or was in contact with the platina on which it was supported, no sensible difference in the

* Philosophical Transactions, 1834, p. 230.

† Ibid. 1821, p. 431.

force of the current was observed. During all the time there was scarcely a trace of decomposing action on the fluoride, and what did occur, seemed referable to the air and moisture of the atmosphere, and not to electrolytic action.

1341. I have now very little doubt that periodide of mercury (414. 448. 691.) is a case of the same kind, and also corrosive sublimate (692.). I am also inclined to think, since making the above experiments, that the anomalous action of the protoxide of antimony, formerly observed and described (693. 801.), may be referred in part to the same cause.

1342. I have no intention at present of going into the particular relation of heat and electricity, but we may hope hereafter to discover by experiment the law which probably holds together all the above effects with those of the *evolution* and the *disappearance* of heat by the current, and the striking and beautiful results of thermo-electricity, in one common bond.

¶ viii. *Electrolytic discharge.*

1343. I have already expressed in a former paper (1164.), the view by which I hope to associate ordinary induction and electrolyzation. Under that view, the discharge of electric forces by electrolyzation is rather an effect superadded, in a certain class of bodies, to those already described as constituting induction and insulation, than one independent of and distinct from these phenomena.

1344. Electrolytes, as respects their insulating and conducting forces, belong to the general category of bodies (1320. 1334.); and if they are in the solid state (as nearly all can assume that state), they retain their place, presenting then no new phenomenon (426. &c.); or if one occur, being in so small a proportion as to be almost unimportant. When liquefied, they also belong to the same list whilst the electric intensity is below a certain degree; but at a given intensity (910. 912. 1007.), fixed for each, and very low in all known cases, they play a new part, causing discharge in proportion (783.) to the development of certain chemical effects of combination and decomposition; and at this point, move out from the general class of insulators and conductors, to form a distinct one by themselves. The former phenomena have been considered (1320. 1338.); it is the latter which have now to be revised, and used as a test of the proposed theory of induction.

1345. The theory assumes, that the particles of the dielectric (now an electrolyte) are in the first instance brought, by ordinary inductive action, into a polarized state, and raised to a certain degree of tension or intensity before discharge commences; the inductive state being, in fact, a *necessary preliminary* to discharge. By taking advantage of those circumstances which bear upon the point, it is not difficult to increase the tension indicative of this state of induction, and so make the state itself more evident. Thus, if distilled water be employed, and a long narrow portion of it placed between the electrodes of a powerful voltaic battery, we have at once indications of the intensity which can be sustained at these electrodes by the inductive action through the water as a dielectric, for sparks may be obtained, gold leaves diverged, and Leyden bottles charged at their wires. The water is in the condition of the spermaceti (1322. 1323.), a bad conductor and a bad insulator; but what it does insulate is by virtue of inductive action, and that induction is the preparation for and precursor of discharge (1338.).

1346. The induction and tension which appear at the limits of the portion of water in the direction of the current, are only the sums of the induction and tension of the contiguous particles between those limits; and the limitation of the inductive tension, to a certain degree shows (time entering in each case as an important element of the result), that when the particles have acquired a certain relative state, *discharge*, or a transfer of forces equivalent to ordinary conduction, takes place.

1347. In the inductive condition assumed by water before discharge comes on, the particles polarized are the particles of the *water*, that being the dielectric used*; but the discharge between particle and particle is not, as before, a mere interchange of their powers or forces at the polar parts, but an actual separation of them into their two elementary particles, the oxygen travelling in one direction, and carrying with it its amount of the force it had acquired during the polarization, and the hydrogen doing the same thing in the other direction, until they each meet the next approaching particle, which is in the same electrical state with that they have left, and by association of their forces with it, produce what constitutes discharge.

* See 1699—1703.—*Dec.* 1838.

This part of the action may be regarded as a carrying one (1319. 1572. 1622.), performed by the constituent particles of the dielectric. The latter is always a compound body (664. 823.); and by those who have considered the subject and are acquainted with the philosophical view of transfer which was first put forth by Grotthuss*, its particles may easily be compared to a series of metallic conductors under inductive action, which, whilst in that state, are divisible into these elementary moveable halves.

1348. Electrolytic discharge depends, of necessity, upon the non-conduction of the dielectric as a whole, and there are two steps or acts in the process: first a polarization of the molecules of the substance, and then a lowering of the forces by the separation, advance in opposite directions, and recombination of the elements of the molecules, these being, as it were, the halves of the originally polarized conductors or particles.

1349. These views of the decomposition of electrolytes and the consequent effect of discharge, which, as to the particular ease, are the same with those of Grotthuss (481.) and Davy (482.), though they differ from those of Biot (487.), De la Rive (490.), and others, seem to me to be fully in accordance not merely with the theory I have given of induction generally (1165.), but with all the known *facts* of common induction, conduction, and electrolytic discharge; and in that respect help to confirm in my mind the truth of the theory set forth. The new mode of discharge which electrolyzation presents must surely be an evidence of the *action of contiguous particles*; and as this appears to depend directly upon a previous inductive state, which is the same with common induction, it greatly strengthens the argument which refers induction in all cases to an action of contiguous particles also (1295, &c.).

1350. As an illustration of the condition of the polarized particles in a dielectric under induction, I may describe an experiment. Put into a glass vessel some clear rectified oil of turpentine, and introduce two wires passing through glass tubes where they coincide with the surface of the fluid, and terminating either in balls or points. Cut some very clean dry white silk into small particles, and put these also into the liquid:

* Annales de Chimie, lviii. 60. and lxiii. 20.

then electrify one of the wires by an ordinary machine and discharge by the other. The silk will immediately gather from all parts of the liquid, and form a band of particles reaching from wire to wire, and if touched by a glass rod will show considerable tenacity; yet the moment the supply of electricity ceases, the band will fall away and disappear by the dispersion of its parts. The *conduction* by the silk is in this case very small; and after the best examination I could give to the effects, the impression on my mind is, that the adhesion of the whole is due to the polarity which each filament acquires, exactly as the particles of iron between the poles of a horse-shoe magnet are held together in one mass by a similar disposition of forces. The particles of silk therefore represent to me the condition of the molecules of the dielectric itself, which I assume to be polar, just as that of the silk is. In all cases of conductive discharge the contiguous polarized particles of the body are able to effect a neutralization of their forces with greater or less facility, as the silk does also in a very slight degree. Further we are not able to carry the parallel, except in imagination; but if we could divide each particle of silk into two halves, and let each half travel until it met and united with the next half in an opposite state, it would then exert its carrying power (1347.), and so far represent electrolytic discharge.

1351. Admitting that electrolytic discharge is a consequence of previous induction, then how evidently do its numerous cases point to induction in curved lines (521. 1216.), and to the divergence or lateral action of the lines of inductive force (1231.), and so strengthen that part of the general argument in the former paper! If two balls of platina, forming the electrodes of a voltaic battery, are put into a large vessel of dilute sulphuric acid, the whole of the surfaces are covered with the respective gases in beautifully regulated proportions, and the mind has no difficulty in conceiving the direction of the curved lines of discharge, and even the intensity of force of the different lines, by the quantity of gas evolved upon the different parts of the surface. From this condition of the lines of inductive force arise the general effects of diffusion; the appearance of the anions or cathions round the edges and on the further side of the electrodes when in the form of plates; and the manner in which the current or discharge will

follow all the forms of the electrolyte, however contorted. Hence, also, the effects which Nobili has so well examined and described* in his papers on the distribution of currents in conducting masses. All these effects indicate the curved direction of the currents or discharges which occur in and through the dielectrics, and these are in every case *preceded* by equivalent inductive actions of the contiguous particles.

1352. Hence also the advantage, when the exciting forces are weak or require assistance, of enlarging the mass of the electrolyte; of increasing the size of the electrodes; of making the coppers surround the zines:—all is in harmony with the view of induction which I am endeavouring to examine; I do not perceive as yet one fact against it.

1353. There are many points of *electrolytic discharge* which ultimately will require to be very closely considered, though I can but slightly touch upon them. It is not that, as far as I have investigated them, they present any contradiction to the view taken (for I have carefully, though unsuccessfully, sought for such cases,) but simply want of time as yet to pursue the inquiry, which prevents me from entering upon them here.

1354. One point is, that different electrolytes or dielectrics require different initial intensities for their decomposition (912.). This may depend upon the degree of polarization which the particles require before electrolytic discharge commences. It is in direct relation to the chemical affinity of the substances concerned; and will probably be found to have a relation or analogy to the specific inductive capacity of different bodies (1252. 1296.). It thus promises to assist in causing the great truths of those extensive sciences, which are occupied in considering the forces of the particles of matter, to fall into much closer order and arrangement than they have heretofore presented.

1355. Another point is the facilitation of electrolytic conducting power or discharge by the addition of substances to the dielectric employed. This effect is strikingly shown where water is the body whose qualities are improved, but, as yet, no general law governing all the phenomena has been

* Bibliothèque Universelle, 1835, lix. 263. 416.

detected. Thus some acids, as the sulphuric, phosphoric, oxalic, and nitric, increase the power of water enormously; whilst others, as the tartaric and citric acids, give but little power; and others, again, as the acetic and boracic acids, do not produce a change sensible to the voltameter (739.). Ammonia produces no effect, but its carbonate does. The caustic alkalies and their carbonates produce a fair effect. Sulphate of soda, nitre (753.), and many soluble salts produce much effect. Percyanide of mercury and corrosive sublimate produce no effect; nor does iodine, gum, or sugar, the test being a voltameter. In many cases the added substance is acted on either directly or indirectly, and then the phenomena are more complicated; such substances are muriatic acid (758.), the soluble protochlorides (766.), and iodides (769.), nitric acid (752.), &c. In other cases the substance added is not, when alone, subject to or a conductor of the powers of the voltaic battery, and yet both gives and receives power when associated with water. M. de la Rive has pointed this result out in sulphurous acid*, iodine and bromine†; the chloride of arsenic produces the same effect. A far more striking case, however, is presented by that very influential body sulphuric acid (681.): and probably phosphoric acid also is in the same peculiar relation.

1356. It would seem in the cases of those bodies which suffer no change themselves, as sulphuric acid (and perhaps in all), that they affect water in its conducting power only as an electrolyte; for whether little or much improved, the decomposition is proportionate to the quantity of electricity passing (727. 730.), and the transfer is therefore due to electrolytic discharge. This is in accordance with the fact already stated as regards water (984.), that the conducting power is not improved for electricity of force below the electrolytic intensity of the substance acting as the dielectric; but both facts (and some others) are against the opinion which I formerly gave, that the power of salts, &c. might depend upon their assumption of the liquid state by solution in the water

* Quarterly Journal, xxvii. 407. or Bibliothèque Universelle, xl. 205. Kemp says sulphurous acid is a very good conductor, Quarterly Journal, 1831, p. 613.

† Quarterly Journal, xxiv. 465. or Annales de Chimie, xxxv. 161.

employed (410.). It occurs to me that the effect may perhaps be related to, and have its explanation in differences of specific inductive capacities.

1357. I have described in the last paper, cases, where shell-lac was rendered a conductor by absorption of ammonia (1294.). The same effect happens with muriatic acid; yet both these substances, when gaseous, are non-conductors; and the ammonia, also when in strong solution (748.). Mr. Harris has mentioned instances* in which the conducting power of metals is seriously altered by a very little alloy. These may have no relation to the former cases, but nevertheless should not be overlooked in the general investigation which the whole question requires.

1358. Nothing is perhaps more striking in that class of dielectrics which we call electrolytes, than the extraordinary and almost complete suspension of their peculiar mode of effecting discharge when they are rendered *solid* (380. &c.), even though the intensity of the induction acting through them may be increased a hundredfold or more (419.). It not only establishes a very general relation between the physical properties of these bodies and electricity acting by induction through them, but draws both their physical and chemical relations so near together, as to make us hope we shall shortly arrive at the full comprehension of the influence they mutually possess over each other.

¶ ix. *Disruptive discharge and insulation.*

1359. The next form of discharge has been distinguished by the adjective *disruptive* (1319.), as it in every case displaces more or less the particles amongst and across which it suddenly breaks. I include under it, discharge in the form of sparks, brushes, and glow (1405.), but exclude the cases of currents of air, fluids, &c., which, though frequently accompanying the former, are essentially distinct in their nature.

1360. The conditions requisite for the production of an electric spark in its simplest form are well known. An insulating dielectric must be interposed between two conducting surfaces in opposite states of electricity, and then if the

* Philosophical Transactions, 1827, p. 22.

actions be continually increased in strength, or otherwise favoured, either by exalting the electric state of the two conductors, or bringing them nearer to each other, or diminishing the density of the dielectric, a *spark* at last appears, and the two forces are for the time annihilated, for *discharge* has occurred.

1361. The conductors (which may be considered as the termini of the inductive action) are in ordinary cases most generally metals, whilst the dielectrics usually employed are common air and glass. In my view of induction, however, every dielectric becomes of importance, for as the results are considered essentially dependent on these bodies, it was to be expected that differences of action never before suspected would be evident upon close examination, and so at once give fresh confirmation of the theory, and open new doors of discovery into the extensive and varied fields of our science. This hope was especially entertained with respect to the gases, because of their high degree of insulation, their uniformity in physical condition, and great difference in chemical properties.

1362. All the effects prior to the discharge are inductive; and the degree of tension which it is necessary to attain before the spark passes is therefore, in the examination I am now making of the new view of induction, a very important point. It is the limit of the influence which the dielectric exerts in resisting discharge; it is a measure, consequently, of the conservative power of the dielectric, which in its turn may be considered as becoming a measure, and therefore a representative of the intensity of the electric forces in activity.

1363. Many philosophers have examined the circumstances of this limiting action in air, but, as far as I know, none have come near Mr. Harris as to the accuracy with, and the extent to, which he has carried on his investigations*. Some of his results I must very briefly notice, premising that they are all obtained with the use of air as the *dielectric* between the conducting surfaces.

1364. First as to the *distance* between the two balls used, or in other words, the *thickness* of the dielectric across which

* Philosophical Transactions, 1834, p. 225.

the induction was sustained. The quantity of electricity, measured by a unit jar, or otherwise on the same principle with the unit jar, in the charged or inductive ball, necessary to produce spark discharge, was found to vary exactly with the distance between the balls, or between the discharging points, and that under very varied and exact forms of experiment*.

1365. Then with respect to variation in the *pressure* or *density* of the air. The quantities of electricity required to produce discharge across a *constant* interval varied exactly with variations of the density; the quantity of electricity and density of the air being in the same simple ratio. Or, if the quantity was retained the same, whilst the interval and density of the air were varied, then these were found in the inverse simple ratio of each other, the same quantity passing across twice the distance with air rarefied to one half †.

1366. It must be remembered that these effects take place without any variation of the *inductive* force by condensation or rarefaction of the air. That force remains the same in air ‡, and in all gasses (1284. 1292.), whatever their rarefaction may be.

1367. Variations of the *temperature* of the air produced no variation of the quantity of electricity required to cause discharge across a given interval §.

Such are the general results, which I have occasion for at present, obtained by Mr. Harris, and they appear to me to be unexceptionable.

1368. In the theory of induction founded upon a molecular action of the dielectric, we have to look to the state of that body principally for the cause and determination of the above effects. Whilst the induction continues, it is assumed that the particles of the dielectric are in a certain polarized state, the tension of this state rising higher in each particle as the induction is raised to a higher degree, either by approximation of the inducing surfaces, variation of form, increase of the original force, or other means; until at last, the tension of the particles having reached the utmost degree which they can sus-

* Philosophical Transactions, 1834, p. 225.

† Ibid. pp. 237, 244.

‡ Ibid. p. 229.

§ Ibid. p. 230.

tain without subversion of the whole arrangement, discharge immediately after takes place.

1369. The theory does not assume, however, that *all* the particles of the dielectric subject to the inductive action are affected to the same amount, or acquire the same tension. What has been called the lateral action of the lines of inductive force (1231. 1297.), and the diverging and occasionally curved form of these lines is against such a notion. The idea is, that any section taken through the dielectric across the lines of inductive force, and including *all of them*, would be equal, in the sum of the forces, to the sum of the forces in any other section; and that, therefore, the whole amount of tension for each such section would be the same.

1370. Discharge probably occurs, not when all the particles have attained to a certain degree of tension, but when that particle which is most affected has been exalted to the subverting or turning point (1410.). For though *all* the particles in the line of induction resist charge, and are associated in their actions so as to give a sum of resisting force, yet when any one is brought up to the overturning point, *all* must give way in the case of a spark between ball and ball. The breaking down of that one must of necessity cause the whole barrier to be overturned, for it was at its utmost degree of resistance when it possessed the aiding power of that one particle, in addition to the power of the rest, and the power of that one is now lost. Hence *tension* or *intensity** may, according to the theory, be considered as represented by the particular condition of the particles, or the amount in them of forced variation from their normal state (1298. 1368.).

1371. The whole effect produced by a charged conductor on a distant conductor, insulated or not, is by my theory assumed to be due to an action propagated from particle to particle of the intervening and insulating dielectric, all the particles being considered as thrown for the time into a forced condition, from which they endeavoured to return to their normal or natural state. The theory, therefore, seems to supply an easy

* See Harris on proposed particular meaning of these terms, *Philosophical Transactions*, 1834, p. 222.

explanation of the influence of *distance* in affecting induction (1303. 1364.). As the distance is diminished induction increases; for there are then fewer particles in the line of inductive force to oppose their united resistance to the assumption of the forced or polarized state, and *vice versa*. Again, as the distance diminishes, discharge across happens with a lower charge of electricity; for if, as in Harris's experiments (1364.), the interval be diminished to one half, then half the electricity required to discharge across the first interval is sufficient to strike across the second; and it is evident, also, that at that time there are only half the number of interposed molecules uniting their forces to resist the discharge.

1372. The effect of enlarging the conducting surfaces which are opposed to each other in the act of induction, is, if the electricity be limited in its supply, to lower the intensity of action; and this follows as a very natural consequence from the increased area of the dielectric across which the induction is effected. For by diffusing the inductive action, which at first was exerted through one square inch of sectional area of the dielectric, over two or three square inches of such area, twice or three times the number of molecules of the dielectric are brought into the polarized condition, and employed in sustaining the inductive action, and consequently the tension belonging to the smaller number on which the limited force was originally accumulated, must fall in a proportionate degree.

1373. For the same reason diminishing these opposing surfaces must increase the intensity, and the effect will increase until the surfaces become points. But in this case, the tension of the particles of the dielectric next the points is higher than that of particles midway, because of the lateral action and consequent bulging, as it were, of the lines of inductive force at the middle distance (1369.).

1374. The more exalted effects of induction on a point *p*, or any small surface, as the rounded end of a rod, when it is opposed to a large surface, as that of a ball or plate, rather than to another point or end, the distance being in both cases the same, fall into harmonious relation with my theory (1302.). For in the latter case, the small surface *p* is affected only by those particles which are brought into the inductive condition by the

equally small surface of the opposed conductor, whereas when that is a ball or plate the lines of inductive force from the latter, are concentrated, as it were, upon the end *p*. Now though the molecules of the dielectrics against the large surface may have a much lower state of tension than those against the corresponding smaller surface, yet they are also far more numerous, and, as the lines of inductive force converge towards a point, are able to communicate to the particles contained in any cross section (1369.) nearer the small surface an amount of tension equal to their own, and consequently much higher for each individual particle; so that at the surface of the smaller conductor, the tension of a particle rises much, and if that conductor were to terminate in a point, the tension would rise to an infinite degree, except that it is limited, as before (1368.), by discharge. The nature of the discharge from small surfaces and points under induction will be resumed hereafter (1425. &c.).

1375. *Rarefaction* of the air does not alter the *intensity* of inductive action (1284. 1287.); nor is there any reason, as far as I can perceive, why it should. If the quantity of electricity and the distance remain the same, and the air be rarefied one half, then, though one half of the particles of the dielectric are removed, the other half assume a double degree of tension in their polarity, and therefore the inductive forces are balanced, and the result remains unaltered as long as the induction and insulation are sustained. But the ease of *discharge* is very different; for as there are only half the number of dielectric particles in the rarefied atmosphere, so these are brought up to the discharging intensity by half the former quantity of electricity; discharge, therefore, ensues, and such a consequence of the theory is in perfect accordance with Mr. Harris's results (1365.).

1376. The *increase* of electricity required to cause discharge over the same distance, when the pressure of the air or its density is increased, flows in a similar manner, and on the same principle (1375.), from the molecular theory.

1377. Here I think my view of induction has a decided advantage over others, especially over that which refers the retention of electricity on the surface of conductors in air to the

pressure of the atmosphere (1305.). The latter is the view which, being adopted by Poisson and Biot*, is also, I believe, that generally received; and it associates two such dissimilar things, as the ponderous air and the subtile and even hypothetical fluid or fluids of electricity, by gross mechanical relations; by the bonds of mere static pressure. My theory, on the contrary, sets out at once by connecting the electric forces with the particles of matter; it derives all its proofs, and even its origin in the first instance, from experiment; and then, without any further assumption, seems to offer at once a full explanation of these and many other singular, peculiar, and, I think, heretofore unconnected effects.

1378. An important assisting experimental argument may here be adduced, derived from the difference of specific inductive capacity of different dielectrics (1269. 1274. 1278.). Consider an insulated sphere electrified positively and placed in the centre of another and larger sphere uninsulated, a uniform dielectric, as air, intervening: The case is really that of my apparatus (1187.), and also, in effect, that of any ball electrified in a room and removed to some distance from irregularly-formed conductors. Whilst things remain in this state the electricity is distributed (so to speak) uniformly over the surface of the electrified sphere. But introduce such a dielectric as sulphur or lac, into the space between the two conductors on one side only, or opposite one part of the inner sphere, and immediately the electricity on the latter is diffused unequally (1229. 1270. 1309.), although the form of the conducting surfaces, their distances, and the *pressure* of the atmosphere remain perfectly unchanged.

1379. Fusinieri took a different view from that of Poisson, Biot, and others, of the reason why rarefaction of air caused easy diffusion of electricity. He considered the effect as due to the removal of the *obstacle* which the air presented to the expansion of the substances from which the electricity passed†. But platina balls show the phenomena in *vacuo* as well as volatile metals and other substances; besides which, when the

* Encyclopædia Britannica, Supplement, vol. iv. Article Electricity, pp. 76, 81, &c.

† Bibl. Univ. 1831. xlviii. 375.

rarefaction is very considerable, the electricity passes with scarcely any resistance, and the production of no sensible heat; so that I think Fusinieri's view of the matter is likely to gain but few assents.

1380. I have no need to remark upon the discharging or collecting power of flame or hot air. I believe, with Harris, that the mere heat does nothing (1367.), the rarefaction only being influential. The effect of rarefaction has been already considered generally (1375.); and that caused by the heat of a burning light, with the pointed form of the wick, and the carrying power of the carbonaceous particles which for the time are associated with it, are fully sufficient to account for all the effects.

1381. We have now arrived at the important question, how will the inductive tension requisite for insulation and disruptive discharge be sustained in gases, which, having the same physical state and also the *same pressure* and the *same temperature* as *air*, differ from it in specific gravity, in chemical qualities, and it may be in peculiar relations, which not being as yet recognized are purely electrical (1361.)?

1382. Into this question I can enter now only as far as is essential for the present argument, namely, that insulation and inductive tension do not depend merely upon the charged conductors employed, but also, and essentially, upon the interposed dielectric, in consequence of the molecular action of its particles (1292.).

1383. A glass vessel *a* (fig. 127.)* was ground at the top and bottom so as to be closed by two ground brass plates, *b* and *c*; *b* carried a stuffing box, with a sliding rod *d* terminated by a brass ball *s* below and a ring above. The lower plate was connected with a foot, stop-cock, and socket, *e*, *f* and *g*; and also with a brass ball *l*, which by means of a stem attached to it and entering the socket *g*, could be fixed at various heights. The metallic parts of this apparatus were not varnished, but the glass was well covered with a coat of shell-lac previously dissolved in alcohol. On exhausting the vessel at the air-pump it could be filled with any other gas than air, and,

* The drawing is to a scale of $\frac{1}{2}$.

in such cases, the gas so passed in was dried whilst entering by fused chloride of calcium.

1384. The other part of the apparatus consisted of two insulating pillars, *h* and *i*, to which were fixed two brass balls, and through these passed two sliding rods, *k* and *m*, terminated at each end by brass balls; *n* is the end of an insulated conductor, which could be rendered either positive or negative from an electrical machine; *o* and *p* are wires connecting it with the two parts previously described, and *q* is a wire which, connecting the two opposite sides of the collateral arrangements, also communicates with a good discharging train *r* (292.).

1385. It is evident that the discharge from the machine electricity may pass either between *s* and *l*, or *S* and *L*. The regulation adopted in the first experiments was to keep *s* and *l* with their distance *unchanged*, but to introduce first one gas and then another into the vessel *a*, and then balance the discharge at the one place against that at the other; for by making the interval at *u* sufficiently small, all the discharge would pass there, or making it sufficiently large it would all occur at the interval *v* in the receiver. On principle it seemed evident, that in this way the varying interval *u* might be taken as a measure, or rather indication of the resistance to discharge through the gas at the constant interval *v*. The following are the constant dimensions.

Ball <i>s</i>	0·93 of an inch.
Ball <i>S</i>	0·96 of an inch.
Ball <i>l</i>	2·02 of an inch.
Ball <i>L</i>	1·95 of an inch.
Interval <i>v</i>	0·62 of an inch.

1386. On proceeding to experiment it was found that when air or any gas was in the receiver *a*, the interval *u* was not a fixed one; it might be altered through a certain range of distance, and yet sparks pass either there or at *v* in the receiver. The extremes were therefore noted, *i. e.* the greatest distance short of that at which the discharge *always* took place at *v* in the gas, and the least distance short of that at which it *always* took place at *u* in the air. Thus, with air in the receiver, the extremes at *u* were 0·56 and 0·79 of an inch, the range of 0·23 between these distances including intervals at which sparks passed occasionally either at one place or the other.

1387. The small balls *s* and *S* could be rendered either positive or negative from the machine, and as gases were expected and were found to differ from each other in relation to this change (1399.), the results obtained under these differences of charge were also noted.

1388. The following is a Table of results; the gas named is that in the vessel *a*. The smallest, greatest, and mean interval at *u* in air is expressed in parts of an inch, the interval *v* being constantly 0.62 of an inch.

	Smallest.	Greatest.	Mean.
{ Air, <i>s</i> and <i>S</i> , pos.	0.60	0.79	0.695
{ Air, <i>s</i> and <i>S</i> , neg.	0.59	0.68	0.635
{ Oxygen, <i>s</i> and <i>S</i> , pos.	0.41	0.60	0.505
{ Oxygen, <i>s</i> and <i>S</i> , neg.	0.50	0.52	0.510
{ Nitrogen, <i>s</i> and <i>S</i> , pos.	0.55	0.68	0.615
{ Nitrogen, <i>s</i> and <i>S</i> , neg.	0.59	0.70	0.645
{ Hydrogen, <i>s</i> and <i>S</i> , pos.	0.30	0.44	0.370
{ Hydrogen, <i>s</i> and <i>S</i> , neg.	0.25	0.30	0.275
{ Carbonic acid, <i>s</i> and <i>S</i> , pos.	0.56	0.72	0.640
{ Carbonic acid, <i>s</i> and <i>S</i> , neg.	0.58	0.60	0.590
{ Olefiant gas, <i>s</i> and <i>S</i> , pos.	0.64	0.86	0.750
{ Olefiant gas, <i>s</i> and <i>S</i> , neg.	0.69	0.77	0.730
{ Coal gas, <i>s</i> and <i>S</i> , pos.	0.37	0.61	0.490
{ Coal gas, <i>s</i> and <i>S</i> , neg.	0.47	0.58	0.525
{ Muriatic acid gas, <i>s</i> and <i>S</i> , pos.	0.89	1.32	1.105
{ Muriatic acid gas, <i>s</i> and <i>S</i> , neg.	0.67	0.75	0.720

1389. The above results were all obtained at one time. On other occasions other experiments were made, which gave generally the same results as to order, though not as to numbers. Thus :

Hydrogen, <i>s</i> and <i>S</i> , pos.	0.23	0.57	0.400
Carbonic acid, <i>s</i> and <i>S</i> , pos.	0.51	1.05	0.780
Olefiant gas, <i>s</i> and <i>S</i> , pos.	0.66	1.27	0.965

I did not notice the difference of the barometer on the days of experiment*.

* Similar experiments in different gases are described at 1507. 1508.—*Dec.* 1838.

1390. One would have expected only two distances, one for each interval, for which the discharge might happen either at one or the other; and that the least alteration of either would immediately cause one to predominate constantly over the other. But that under common circumstances is not the case. With air in the receiver, the variation amounted to 0.2 of an inch nearly on the smaller interval of 0.6, and with muriatic acid gas, the variation was above 0.4 on the smaller interval of 0.9. Why is it that when a fixed interval (the one in the receiver) will pass a spark that cannot go across 0.6 of air at one time, it will immediately after, and apparently under exactly similar circumstances, not pass a spark that can go across 0.8 of air?

1391. It is probable that part of this variation will be traced to particles of dust in the air drawn into and about the circuit (1568.). I believe also that part depends upon a variable charged condition of the surface of the glass vessel *a*. That the whole of the effect is not traceable to the influence of circumstances in the vessel *a*, may be deduced from the fact, that when sparks occur between balls in free air they frequently are not straight, and often pass otherwise than by the shortest distance. These variations in air itself, and at different parts of the very same balls, shows the presence and influence of circumstances which are calculated to produce effects of the kind now under consideration.

1392. When a spark had passed at either interval, then, generally, more tended to appear at the *same* interval, as if a preparation had been made for the passing of the latter sparks. So also on continuing to work the machine quickly the sparks generally followed at the same place. This effect is probably due in part to the warmth of the air heated by the preceding spark, in part to dust, and I suspect in part to something unperceived as yet in the circumstances of discharge.

1393. A very remarkable difference, which is *constant* in its direction, occurs when the electricity communicated to the balls *s* and *S* is changed from positive to negative, or in the contrary direction. It is that the range of variation is always greater when the small balls are positive than when they are negative. This is exhibited in the following Table, drawn from the former experiments.

	Pos.	Neg.
In Air the range was . . .	0·19	0·09
Oxygen.	0·19	0·02
Nitrogen	0·13	0·11
Hydrogen	0·14	0·05
Carbonic acid.	0·16	0·02
Olefiant gas	0·22	0·08
Coal gas	0·24	0·12
Muriatic acid.	0·43	0·08

I have no doubt these numbers require considerable correction, but the general result is striking, and the differences in several cases very great.

1394. Though, in consequence of the variation of the striking distance (1386.), the interval in air fails to be a measure, as yet, of the insulating or resisting power of the gas in the vessel, yet we may for present purposes take the mean interval as representing in some degree that power. On examining these mean intervals as they are given in the third column (1388.), it will be very evident, that gases, when employed as dielectrics, have peculiar electrical relations to insulation, and therefore to induction, very distinct from such as might be supposed to depend upon their mere physical qualities of specific gravity or pressure.

1395. First, it is clear that at the *same pressure* they are not alike, the difference being as great as 37 and 110. When the small balls are charged positively, and with the same surfaces and the same pressure, muriatic acid gas has three times the insulating or restraining power (1362.) of hydrogen gas, and nearly twice that of oxygen, nitrogen, or air.

1396. Yet it is evident that the difference is not due to specific gravity, for though hydrogen is the lowest, and therefore lower than oxygen, oxygen is much beneath nitrogen, or than olefiant gas; and carbonic acid gas, though considerably heavier than olefiant gas or muriatic acid gas, is lower than either. Oxygen as a heavy, and olefiant as a light gas, are in strong contrast with each other; and if we may reason of olefiant gas from Harris's results with air (1365.), then it might be rarefied to two-thirds its usual density, or to a specific gravity of 9·3 (hydrogen being 1), and having neither the same density nor

pressure as oxygen, would have equal insulating powers with it, or equal tendency to resist discharge.

1397. Experiments have already been described (1291. 1292.) which show that the gases are sensibly alike in their inductive capacity. This result is not in contradiction with the existence of great differences in their restraining power. The same point has been observed already in regard to dense and rare air (1375.).

1398. Hence arises a new argument proving that it cannot be mere pressure of the atmosphere which prevents or governs discharge (1377. 1378.), but a specific electric quality or relation of the gaseous medium. Hence also additional argument for the theory of molecular inductive action.

1399. Other specific differences amongst the gases may be drawn from the preceding series of experiments, rough and hasty as they are. Thus the positive and negative series of mean intervals do not give the same differences. It has been already noticed that the negative numbers are lower than the positive (1393.), but, besides that, the *order* of the positive and negative results is not the same. Thus, on comparing the mean numbers (which represent for the present insulating tension,) it appears that in air, hydrogen, carbonic acid, olefiant gas and muriatic acid, the tension rose higher when the smaller ball was made positive than when rendered negative, whilst in oxygen, nitrogen, and coal gas, the reverse was the case. Now though the numbers cannot be trusted as exact, and though air, oxygen, and nitrogen should probably be on the same side, yet some of the results, as, for instance, those with muriatic acid, fully show a peculiar relation and difference amongst gases in this respect. This was further proved by making the interval in air 0.8 of an inch whilst muriatic acid gas was in the vessel *a*; for on charging the small balls *s* and *S* positively, *all* the discharge took place through the *air*; but on charging them negatively, *all* the discharge took place through the *muriatic acid gas*.

1400. So also, when the conductor *n* was connected *only* with the muriatic acid gas apparatus, it was found that the discharge was more facile when the small ball *s* was negative than when positive; for in the latter case, much of the electricity passed

off as brush discharge through the air from the connecting wire p ; but in the former case it all seemed to go through the muriatic acid.

1401. The consideration, however, of positive and negative discharge across air and other gases will be resumed in the further part of this, or in the next paper (1465. 1525.).

1402. Here for the present I must leave this part of the subject, which had for its object only to observe how far gases agreed or differed as to their power of retaining a charge on bodies acting by induction through them. All the results conspire to show that Induction is an action of contiguous molecules (1295. &c.); but besides confirming this, the first principle placed for proof in the present inquiry, they greatly assist in developing the specific properties of each gaseous dielectric, at the same time showing that further and extensive experimental investigation is necessary, and holding out the promise of new discovery as the reward of the labour required.

1403. When we pass from the consideration of dielectrics like the gases to that of bodies having the liquid and solid condition, then our reasonings in the present state of the subject assume much more of the character of mere supposition. Still I do not perceive anything adverse to the theory, in the phenomena which such bodies present. If we take three insulating dielectrics, as air, oil of turpentine and shell-lac, and use the same balls or conductors at the same intervals in these three substances, increasing the intensity of the induction until discharge take place, we shall find that it must be raised much higher in the fluid than for the gas, and higher still in the solid than for the fluid. Nor is this inconsistent with the theory; for with the liquid, though its molecules are free to move almost as easily as those of the gas, there are many more particles introduced into the given interval; and such is also the case when the solid body is employed. Besides that with the solid, the cohesive force of the body used will produce some effect; for though the production of the polarized states in the particle of a solid may not be obstructed, but, on the contrary, may in some cases be even favoured (1164. 1344.) by its solidity or other circumstances, yet solidity may well exert an influence on the

point of final subversion, (just as it prevents discharge in an electrolyte,) and so enable inductive intensity to rise to a much higher degree.

1404. In the cases of solids and liquids too, bodies may, and most probably do, possess specific differences as to their ability of assuming the polarized state, and also as to the extent to which that polarity must rise before discharge occurs. An analogous difference exists in the specific inductive capacities already pointed out in a few substances (1278.) in the last paper. Such a difference might even account for the various degrees of insulating and conducting power possessed by different bodies, and, if it should be found to exist, would add further strength to the argument in favour of the molecular theory of inductive action.

1405. Having considered these various cases of sustained insulation in non-conducting dielectrics up to the highest point which they can attain, we find that they terminate at last in *disruptive discharge*; the peculiar condition of the molecules of the dielectric which was necessary to the continuous induction, being equally essential to the occurrence of that effect which closes all the phenomena. This discharge is not only in its appearance and condition different to the former modes by which the lowering of the powers was effected (1320. 1343.), but, whilst really the same in principle, varies much from itself in certain characters, and thus presents us with the forms of *spark*, *brush*, and *glow* (1359.). I will first consider *the spark*, limiting it for the present to the case of discharge between two oppositely electrified conducting surfaces.

The electric spark or flash.

1406. The *spark* is consequent upon a discharge or lowering of the polarized inductive state of many dielectric particles, by a particular action of a few of the particles occupying a very small and limited space; all the previously polarized particles returning to their first or normal condition in the inverse order in which they left it, and uniting their powers meanwhile to produce, or rather to continue, (1417.—1436.) the discharge effect in the place where the subversion of force first occurred.

My impression is, that the few particles situated where discharge occurs are not merely pushed apart, but assume a peculiar state, a highly exalted condition for the time, *i. e.* have thrown upon them all the surrounding forces in succession, and rising up to a proportionate intensity of condition, perhaps equal to that of chemically combining atoms, discharge the powers, possibly in the same manner as they do theirs, by some operation at present unknown to us; and so the end of the whole. The ultimate effect is exactly as if a metallic wire had been put into the place of the discharging particles; and it does not seem impossible that the principles of action in both cases, may, hereafter, prove to be the same.

1407. The *path of the spark*, or of the discharge, depends on the degree of tension acquired by the particles in the line of discharge, circumstances, which in every common case are very evident and by the theory easy to understand, rendering it higher in them than in their neighbours, and, by exalting them first to the requisite condition, causing them to determine the course of the discharge. Hence the selection of the path, and the solution of the wonder which Harris has so well described* as existing under the old theory. All is prepared amongst the molecules beforehand, by the prior induction, for the path either of the electric spark or of lightning itself.

1408. The same difficulty is expressed as a principle by Nobili for voltaic electricity, almost in Mr. Harris's words, namely †, "electricity directs itself towards the point where it can most easily discharge itself," and the results of this as a principle he has well wrought out for the case of voltaic currents. But the *solution* of the difficulty, or the proximate cause of the effects, is the same; induction brings the particles up to or towards a certain degree of tension (1370.); and by those which first attain it, is the discharge first and most efficiently performed.

1409. The *moment* of discharge is probably determined by that molecule of the dielectric which, from the circumstances has its tension most quickly raised up to the maximum intensity. In all cases where the discharge passes from conductor to conductor this molecule must be on the surface of one of

* Nautical Magazine, 1834, p. 229.

† Bibliothèque Universelle, 1835, lix. 275.

them; but when it passes between a conductor and a non-conductor, it is, perhaps, not always so (1453.). When this particle has acquired its maximum tension, then the whole barrier of resistance is broken down in the line or lines of inductive action originating at it, and disruptive discharge occurs (1370.): and such an inference, drawn as it is from the theory, seems to me in accordance with Mr. Harris's facts and conclusions respecting the resistance of the atmosphere, namely, that it is not really greater at any one discharging distance than another*.

1410. It seems probable, that the tension of a particle of the same dielectric, as air, which is requisite to produce discharge, is a *constant quantity*, whatever the shape of the part of the conductor with which it is in contact, whether ball or point; whatever the thickness or depth of dielectric throughout which induction is exerted; perhaps, even, whatever the state, as to rarefaction or condensation of the dielectric; and whatever the nature of the conductor, good or bad, with which the particle is for the moment associated. In saying so much, I do not mean to exclude small differences which may be caused by the reaction of neighbouring particles on the deciding particle, and indeed, it is evident that the intensity required in a particle must be related to the condition of those which are contiguous. But if the expectation should be found to approximate to truth, what a generality of character it presents! and, in the definiteness of the power possessed by a particular molecule, may we not hope to find an immediate relation to the force which, being electrical, is equally definite and constitutes chemical affinity?

1411. Theoretically it would seem that, at the moment of discharge by the spark in one line of inductive force, not merely would all the other lines throw their forces into this one (1406.), but the lateral effect, equivalent to a repulsion of these lines (1224. 1297.) would be relieved and, perhaps, followed by a contrary action, amounting to a collapse or attraction of these parts. Having long sought for some transverse force in statical electricity, which should be the equivalent to magnetism or the transverse force of current electricity, and conceiving that it might be connected with the transverse action of the lines of inductive force already described (1297.), I was desi-

* Philosophical Transactions, 1834, pp. 227, 229.

rous, by various experiments, of bringing out the effect of such a force, and making it tell upon the phenomena of electro-magnetism and magneto-electricity*.

1412. Amongst other results, I expected and sought for the mutual affection, or even the lateral coalition of two similar sparks, if they could be obtained simultaneously side by side, and sufficiently near to each other. For this purpose, two similar Leyden jars were supplied with rods of copper projecting from their balls in a horizontal direction, the rods being about 0·2 of an inch thick, and rounded at the ends. The jars were placed upon a sheet of tinfoil, and so adjusted that their rods, *a* and *b*, were near together, in the position represented in plan at fig. 116; *c* and *d* were two brass balls connected by a brass rod and insulated: *e* was also a brass ball connected, by a wire, with the ground and with the tinfoil upon which the Leyden jars were placed. By laying an insulated metal rod across from *a* to *b*, charging the jars, and removing the rod, both the jars could be brought up to the same intensity of charge (1370.). Then, making the ball *e* approach the ball *d*, at the moment the spark passed there, two sparks passed between the rods *n*, *o*, and the ball *c*; and as far as the eye could judge, or the conditions determine, they were simultaneous.

1413. Under these circumstances two modes of discharge took place; either each end had its own particular spark to the ball, or else one end only was associated by a spark with the ball, but was at the same time related to the other end by a spark between the two.

1414. When the ball *c* was about an inch in diameter, the ends *n* and *o*, about half an inch from it, and about 0·4 of an inch from each other, the two sparks to the ball could be obtained. When, for the purpose of bringing the sparks nearer together, the ends, *n* and *o*, were brought closer to each other, then, unless very carefully adjusted, only one end had a spark with the ball, the other having a spark to it; and the least variation of position would cause either *n* or *o* to be the end which, giving the direct spark to the ball, was also the one through, or by means of which, the other discharged its electricity.

1415. On making the ball *c* smaller, I found that then it was

* See further investigations of this subject, 1658—1666, 1709—1735.—*Dec.* 1838.

needful to make the interval between the ends *n* and *o* larger in proportion to the distance between them and the ball *c*. On making *c* larger, I found I could diminish the interval, and so bring the two simultaneous separate sparks closer together, until, at last, the distance between them was not more at the widest part than 0.6 of their whole length.

1416. Numerous sparks were then passed and carefully observed. They were very rarely straight, but either curved or bent irregularly. In the average of cases they were, I think, decidedly convex towards each other; perhaps two-thirds presented more or less of this effect, the rest bulging more or less outwards. I was never able, however, to obtain sparks which, separately leaving the ends of the wires *n* and *o*, conjoined into one spark before they reached or communicated with the ball *c*. At present, therefore, though I think I saw a tendency in the sparks to unite, I cannot assert it as a fact.

1417. But there is one very interesting effect here, analogous to, and it may be in part the same with, that I was searching for: I mean the increased facility of discharge where the spark passes. For instance, in the cases where one end, as *n*, discharged the electricity of both ends to the ball *c*, fig. 116, the electricity of the other end *o*, had to pass through an interval of air 1.5 times as great as that which it might have taken, by its direct passage between the end and the ball itself. In such cases, the eye could not distinguish, even by the use of Wheatstone's means*, that the spark from the end *n*, which contained both portions of electricity, was a double spark. It could not have consisted of two sparks taking separate courses, for such an effect would have been visible to the eye; but it is just possible, that the spark of the first end *n* and its jar, passing at the smallest interval of time before that of the other *o*, had heated and expanded the air in its course, and made it so much more favourable to discharge, that the electricity of the end *o* preferred leaping across to it and taking a very circuitous route, rather than the more direct one to the ball. It must, however, be remarked, in answer to this supposition, that the one spark between *d* and *e* would, by its influence, tend to produce simultaneous discharges at *n* and *o*, and certainly did so,

* Philosophical Transactions, 1834, pp. 584, 585.

when no preponderance was given to one wire over the other, as to the previous inductive effect (1414.).

1418. The fact, however, is, that the disruptive discharge is favourable to itself. It is at the outset a case of tottering equilibrium: and if *time* be an element in discharge, in however minute a proportion (1436.), then the commencement of the act at any point favours its continuance and increase there, and portions of power will be discharged by a course which they would not otherwise have taken.

1419. The mere heating and expansion of the air itself by the first portion of electricity which passes, must have a great influence in producing this result.

1420. As to the result itself, we see its effect in every electric spark; for it is not the whole quantity which passes that determines the discharge, but merely that small portion of force which brings the deciding molecule (1370.) up to its maximum tension; then, when its forces are subverted and discharge begins, all the rest passes by the same course, from the influence of the favouring circumstances just referred to; and whether it be the electricity on a square inch, or a thousand square inches of charged glass, the discharge is complete. Hereafter we shall find the influence of this effect in the formation of brushes (1435.); and it is not impossible that we may trace it producing the jagged spark and the forked lightning.

1421. The characters of the electric spark in *different gases* vary, and the variation *may* be due simply to the effect of the heat evolved at the moment. But it may also be due to that specific relation of the particles and the electric forces which I have assumed as the basis of a theory of induction; the facts do not oppose such a view; and in that view, the variation strengthens the argument for molecular action, as it would seem to show the influence of the latter in every part of the electrical effect (1423. 1454.).

1422. The appearances of the sparks in different gases have often been observed and recorded*, but I think it not out of

* See Van Marum's description of the Teylerian machine, vol. i. p. 112., and vol. ii. p. 196.; also Ency. Britan., vol. vi., Article Electricity, pp. 505, 507.

place to notice briefly the following results : they were obtained with balls of brass, (platina surfaces would have been better,) and at common pressures. In *air*, the sparks have that intense light and bluish colour which are so well known, and often have faint or dark parts in their course, when the quantity of electricity passing is not great. In *nitrogen*, they are very beautiful, having the same general appearance as in air, but have decidedly more colour of a bluish or purple character, and I thought were remarkably sonorous. In *oxygen*, the sparks were whiter than in air or nitrogen, and I think not so brilliant. In *hydrogen*, they had a very fine crimson colour, not due to its rarity, for the character passed away as the atmosphere was rarefied (1459)*. Very little sound was produced in this gas ; but that is a consequence of its physical condition †. In *carbonic acid gas*, the colour was similar to that of the spark in air, but with a little green in it : the sparks were remarkably irregular in form, more so than in common air : they could also, under similar circumstances as to size of ball, &c., be obtained much longer than in air, the gas showing a singular readiness to cause the discharge in the form of a spark. In *muritic acid gas*, the spark was nearly white : it was always bright throughout, never presenting those dark parts which happen in air, nitrogen, and some other gases. The gas was dry, and during the whole experiment the surface of the glass globe within remained quite dry and bright. In *coal gas*, the spark was sometimes green, sometimes red, and occasionally one part was green and another red : black parts also occur very suddenly in the line of the spark, *i. e.* they are not connected by any dull part with bright portions, but the two seem to join directly one with the other.

1423. These varieties of character impress my mind with a feeling, that they are due to a direct relation of the electric powers to the particles of the dielectric through which the discharge occurs, and are not the mere results of a casual ignition or a secondary kind of action of the electricity, upon

* Van Marum says they are about four times as large in hydrogen as in air, vol. i. p. 122.

† Leslie. Cambridge Phil. Transactions, 267.

the particles which it finds in its course and thrusts aside in its passage (1454).

1424. The spark may be obtained in media which are far denser than air, as in oil of turpentine, olive oil, resin, glass, &c. : it may also be obtained in bodies which being denser likewise approximate to the condition of conductors, as spermaceti, water, &c. But in these cases, nothing occurs which, as far as I can perceive, is at all hostile to the general views I have endeavoured to advocate.

The electrical brush.

1425. The *brush* is the next form of disruptive discharge which I shall consider. There are many ways of obtaining it, or rather of exalting its characters ; and all these ways illustrate the principles upon which it is produced. If an insulated conductor, connected with the positive conductor of an electrical machine, have a metal rod 0·3 of an inch in diameter projecting from it outwards from the machine, and terminating by a rounded end or a small ball, it will generally give good brushes ; or, if the machine be not in good action, then many ways of assisting the formation of the brush can be resorted to ; thus, the hand or any *large* conducting surface may be approached towards the termination to increase inductive force (1374.) : or the termination may be smaller and of badly conducting matter, as wood : or sparks may be taken between the prime conductor of the machine and the secondary conductor to which the termination giving brushes belongs ; or, which gives to the brushes exceedingly fine characters and great magnitude, the air around the termination may be rarefied more or less, either by heat or the air pump ; the former favourable circumstances being also continued.

1426. The brush when obtained by a powerful machine on a ball about 0·7 of an inch in diameter, at the end of a long brass rod attached to the positive prime conductor, had the general appearance as to form represented in fig. 117. : a short conical bright part or root appeared at the middle part of the ball projecting directly from it, which, at a little distance from the ball, broke out suddenly into a wide brush of pale ramifi-

eations having a quivering motion, and being accompanied at the same time with a low dull chattering sound.

1427. At first the brush seems continuous, but Professor Wheatstone has shown that the whole phenomenon consists of successive intermittent discharges*. If the eye be passed rapidly, not by a motion of the head, but of the eyeball itself, across the direction of the brush, by first looking steadfastly about 10° or 15° above, and then instantly as much below it, the general brush will be resolved into a number of individual brushes, standing in a row upon the line which the eye passed over ; each elementary brush being the result of a single discharge, and the space between them representing both the time during which the eye was passing over that space, and that which elapsed between one discharge and another.

1428. The single brushes could easily be separated to eight or ten times their own width, but were not at the same time extended, *i. e.* they did not become more indefinite in shape, but, on the contrary, less so, each being more distinct in form, ramification, and character, because of its separation from the others, in its effects upon the eye. Each, therefore, was instantaneous in its existence (1436.). Each had the conical root complete (1426.).

1429. On using a smaller ball, the general brush was smaller, and the sound, though weaker, more continuous. On resolving the brush into its elementary parts, as before, these were found to occur at much shorter intervals of time than in the former case, but still the discharge was intermitting.

1430. Employing a wire with a round end, the brush was still smaller, but, as before, separable into successive discharges. The sound, though feebler, was higher in pitch, being a distinct musical note.

1431. The sound is, in fact, due to the recurrence of the noise of each separate discharge, and these, happening at intervals nearly equal under ordinary circumstances, cause a definite note to be heard, which, rising in pitch with the increased rapidity and regularity of the intermitting discharges, gives a ready and accurate measure of the intervals, and so may be used in any case when the discharge is heard, even though the appearances

* Philosophical Transactions, 1834, p. 586.

may not be seen, to determine the element of *time*. So when, by bringing the hand towards a projecting rod or ball, the pitch of the tone produced by a brushy discharge increases, the effect informs us that we have increased the induction (1374.), and by that means increased the rapidity of the alternations of charge and discharge.

1432. By using wires with finer terminations, smaller brushes were obtained, until they could hardly be distinguished as brushes; but as long as *sound* was heard, the discharge could be ascertained by the eye to be intermitting; and when the sound ceased, the light became *continuous* as a glow (1359. 1405. 1526—1543.).

1433. To those not accustomed to use the eye in the manner I have described, or, in cases where the recurrence is too quick for any unassisted eye, the beautiful revolving mirror of Professor Wheatstone* will be useful for such developments of condition as those mentioned above. Another excellent process is to produce the brush or other luminous phenomenon on the end of a rod held in the hand opposite to a charged positive or negative conductor, and then move the rod rapidly from side to side whilst the eye remains still. The successive discharges occur of course in different places, and the state of things before, at, and after a single coruscation or brush can be exceedingly well separated.

1434. The *brush* is in reality a discharge between a bad or a non-conductor and either a conductor or another non-conductor. Under common circumstances, the brush is a discharge between a conductor and air, and I conceive it to take place in something like the following manner. When the end of an electrified rod projects into the middle of a room, induction takes place between it and the walls of the room, across the dielectric, air; and the lines of inductive force accumulate upon the end in greater quantity than elsewhere, or the particles of air at the end of the rod are more highly polarized than those at any other part of the rod, for the reasons already given (1374.). The particles of air situated in sections across these lines of force are least polarized in the sections towards the walls, and most polarized in those nearer

* Philosophical Transactions, 1834, pp. 584, 585.

to the end of the wires (1369.) : thus, it may well happen, that a particle at the end of the wire is at a tension that will immediately terminate in discharge, whilst in those even only a few inches off, the tension is still beneath that point. But suppose the rod to be charged positively, a particle of air A, fig. 118. next it, being polarized, and having of course its negative force directed towards the rod and its positive force outwards ; the instant that discharge takes place between the positive force of the particle of the rod opposite the air and the negative force of the particle of air towards the rod, the whole particle of air becomes positively electrified ; and when, the next instant, the discharged part of the rod resumes its positive state by conduction from the surface of metal behind, it not only acts on the particles beyond A, by throwing A into a polarized state again, but A itself, because of its charged state, exerts a distinct inductive act towards these further particles, and the tension is consequently so much exalted between A and B, that discharge takes place there also, as well as again between the metal and A.

1435. In addition to this effect, it has been shown, that, the act of discharge having once commenced, the whole operation, like a case of unstable equilibrium, is hastened to a conclusion (1370. 1418.), the rest of the act being facilitated in its occurrence, and other electricity than that which caused the first necessary tension hurrying to the spot. When, therefore, disruptive discharge has once commenced at the root of a brush, the electric force which has been accumulating in the conductor attached to the rod, finds a more ready discharge there than elsewhere, and will at once follow the course marked out as it were for it, thus leaving the conductor in a partially discharged state, and the air about the end of the wire in a charged condition ; and the time necessary for restoring the full charge of the conductor, and the dispersion of the charged air in a greater or smaller degree, by the joint forces of repulsion from the conductor and attraction towards the walls of the room, to which its inductive action is directed, is just that time which forms the interval between brush and brush (1420. 1427. 1431. 1447.).

1436. The words of this description are long, but there is nothing in the act or the forces on which it depends to prevent

the discharge being *instantaneous*, as far as we can estimate and measure it. The consideration of *time* is, however, important in several points of view (1418.), and in reference to disruptive discharge, it seemed from theory far more probable that it might be detected in a brush than in a spark; for in a brush, the particles in the line through which the discharge passes are in very different states as to intensity, and the discharge is already complete in its act at the root of the brush, before the particles at the extremity of the ramifications have yet attained their maximum intensity.

1437. I consider *brush* discharge as, probably a successive effect in this way. Discharge begins at the root (1426. 1553.), and, extending itself in succession to all parts of the single brush, continues to go on at the root and the previously formed parts until the whole brush is complete; then, by the fall in intensity and power at the conductor, it ceases at once in all parts, to be renewed, when that power has risen again to a sufficient degree. But in a *spark*, the particles in the line of discharge being, from the circumstances, nearly alike in their intensity of polarization, suffer discharge so nearly at the same moment as to make the time quite insensible to us.

1438. Mr. Wheatstone has already made experiments which fully illustrate this point. He found that the brush generally had a sensible duration, but that with its highest capabilities he could not detect any such effect in the spark*. I repeated his experiment on the brush, though with more imperfect means, to ascertain whether I could distinguish a longer duration in the stem or root of the brush than in the extremities, and the appearances were such as to make me think an effect of this kind was produced.

1439. That the discharge breaks into several ramifications, and by them passes through portions of air alike, or nearly alike, as to polarization and the degree of tension the particles there have acquired, is a very natural result of the previous state of things, and rather to be expected than that the discharge should continue to go straight out into space in a single line amongst those particles which, being at a distance from the end of the rod, are in a lower state of tension than those which are near: and whilst we cannot but conclude, that those

* Philosophical Transactions, 1836, pp. 586, 590.

parts where the branches of a single brush appear, are more favourably circumstanced for discharge than the darker parts between the ramifications, we may also conclude, that in those parts where the light of concomitant discharge is equal, there the circumstances are nearly equal also. The single successive brushes are by no means of the same particular shape even when they are observed without displacement of the rod or surrounding objects (1427. 1433.), and the successive discharges may be considered as taking place into the mass of air around, through different roads at each brush, according as minute circumstances, such as dust, &c. (1391. 1392.) may have favoured the course by one set of particles rather than another.

1440. Brush discharge does not essentially require any current of the medium in which the brush appears: the current almost always occurs, but is a consequence of the brush, and will be considered hereafter (1562.—1610.). On holding a blunt point positively charged towards uninsulated water, a star or glow appeared on the point, a current of air passed from it, and the surface of the water was depressed; but on bringing the point so near that sonorous brushes passed, then the current of air instantly ceased, and the surface of the water became level.

1441. The discharge by a brush is not to all the particles of air that are near the electrified conductor from which the brush issues; only those parts where the ramifications pass are electrified: the air in the central dark parts between them receives no charge, and, in fact, at the time of discharge, has its electric and inductive tension considerably lowered. For consider fig. 128, to represent a single positive brush;—the induction before the discharge is from the end of the rod outwards, in diverging lines towards the distant conductors, as the walls of the room, &c., and a particle at *a* has polarity of a certain degree of tension, and tends with a certain force to become charged; but at the moment of discharge, the air in the ramifications *b* and *d*, acquiring also a positive state, opposes its influence to that of the positive conductor on *a*, and the tension of the particle at *a* is therefore diminished rather than increased. The charged particles at *b* and *d* are now inductive bodies, but their lines of inductive action are still outwards towards the walls of the room; the direction of the polarity and

the tendency of other particles to charge from these, being governed by, or in conformity with, these lines of force.

1442. The particles that are charged are probably very highly charged, but the medium being a non-conductor, they cannot communicate that state to their neighbours. They travel, therefore, under the influence of the repulsive and attractive forces, from the charged conductor towards the nearest un-insulated conductor, or the nearest body in a different state to themselves, just as charged particles of dust would travel, and are then discharged; each particle acting, in its course, as a centre of inductive force upon any bodies near which it may come. The travelling of these charged particles when they are numerous, causes wind and currents, but these will come into consideration under *carrying discharge* (1319. 1562. &c.).

1443. When air is said to be electrified, and it frequently assumes this state near electrical machines, it consists, according to my view, of a mixture of electrified and unelectrified particles, the latter being in very large proportion to the former. When we gather electricity from air, by a flame or by wires, it is either by the actual discharge of these particles, or by effects dependent on their inductive action, a case of either kind being produceable at pleasure. That the law of equality between the two forces or forms of force in inductive action is as strictly preserved in these as in other cases, is fully shown by the fact, formerly stated (1173. 1174.), that, however strongly air in a vessel might be charged positively, there was an exactly equal amount of negative force on the inner surface of the vessel itself, for no residual portion of either the one or the other electricity could be obtained.

1444. I have nowhere said, nor does it follow, that the air is charged only where the luminous brush appears. The charging may extend beyond those parts which are visible, *i. e.* particles to the right or left of the lines of light may receive electricity, the parts which are luminous being so only because much electricity is passing by them to other parts (1437.); just as in a spark discharge the light is greater as more electricity passes, though it has no necessary relation to the quantity required to commence discharge (1370. 1420.). Hence the form we see in a brush may by no means represent the whole

quantity of air electrified ; for an invisible portion, clothing the visible form to a certain depth, may, at the same time, receive its charge (1552.).

1445. Several effects which I have met with in muriatic acid gas tend to make me believe, that that gaseous body allows of a dark discharge. At the same time, it is quite clear from theory, that in some gases, the reverse of this may occur, *i. e.* that the charging of the air may not extend even so far as the light. We do not know as yet enough of the electric light to be able to state on what it depends, and it is very possible that, when electricity bursts forth into air, all the particles of which are in state of tension, light may be evolved by such as, being very near to, are not of, those which actually receive a charge at the time.

1446. The further a brush extends in a gas, the further no doubt is the charge or discharge carried forward ; but this may vary between different gases, and yet the intensity required for the first moment of discharge not vary in the same, but in some other proportion. Thus with respect to nitrogen and muriatic acid gases, the former, as far as my experiments have proceeded, produces far finer and larger brushes than the latter (1458. 1462.), but the intensity required to commence discharge is much higher for the muriatic acid than the nitrogen (1395.). Here again, therefore, as in many other qualities, specific differences are presented by different gaseous dielectrics, and so prove the special relation of the latter to the act and the phenomena of induction.

1447. To sum up these considerations respecting the character and condition of the brush, I may state that it is a spark to air ; a diffusion of electric force to matter, not by conduction, but disruptive discharge ; a dilute spark which, passing to very badly conducting matter, frequently discharges but a small portion of the power stored up in the conductor ; for as the air charged reacts on the conductor, whilst the conductor, by loss of electricity, sinks in its force (1435.), the discharge quickly ceases, until by the dispersion of the charged air and the renewal of the excited conditions of the conductor, circumstances have risen up to their first effective condition, again to cause discharge, and again to fall and rise.

1448. The brush and spark gradually pass into one another.

Making a small ball positive by a good electrical machine with a large prime conductor, and approaching a large uninsulated discharging ball towards it, very beautiful variations from the spark to the brush may be obtained. The drawings of long and powerful sparks, given by Van Marum*, Harris †, and others, also indicate the same phenomena. As far as I have observed, whenever the spark has been brushy in air of common pressures, the whole of the electricity has not been discharged, but only portions of it, more or less according to circumstances; whereas, whenever the effect has been a distinct spark throughout the whole of its course, the discharge has been perfect, provided no interruption had been made to it elsewhere, in the discharging circuit, than where the spark occurred.

1449. When an electrical brush from an inch to six inches in length or more is issuing into free air, it has the form given, fig. 117. But if the hand, a ball, or any knobbed conductor be brought near, the extremities of the coruscations turn towards it and each other, and the whole assumes various forms according to circumstances, as in figs. 119, 120, and 121. The influence of the circumstances in each case is easily traced, and I might describe it here, but that I should be ashamed to occupy the time of the Society in things so evident. But how beautifully does the curvature of the ramifications illustrate the curved form of the lines of inductive force existing previous to the discharge! for the former are consequences of the latter, and take their course, in each discharge, where the previous inductive tension had been raised to the proper degree. They represent these curves just as well as iron filings represent magnetic curves, the visible effects in both cases being the consequences of the action of the forces in *the places where* the effects appear. The phenomena, therefore, constitute additional and powerful testimony (1216. 1230.) to that already given in favour both of induction through dielectrics in curved lines (1231.), and of the lateral relation of these lines, by an effect equivalent to a repulsion producing divergence, or, as in the cases figured, the bulging form.

1450. In reference to the theory of molecular inductive ac-

* Description of the Teylerian machine, vol. i. pp. 28, 32.; vol. ii. p. 226, &c.

† Philosophical Transactions, 1834, p. 243.

tion, I may also add, the proof deducible from the long brushy ramifying spark which may be obtained between a small ball on the positive conductor of an electrical machine, and a larger one at a distance (1448. 1504.). What a fine illustration that spark affords of the previous condition of *all* the particles of the dielectric between the surfaces of discharge, and how unlike the appearances are to any which would be deduced from the theory which assumes inductive action to be action at a distance, in straight lines only ; and charge, as being electricity retained upon the surface of conductors by the mere pressure of the atmosphere !

1451. When the brush is obtained in rarefied air, the appearances vary greatly, according to circumstances, and are exceedingly beautiful. Sometimes a brush may be formed of only six or seven branches, these being broad and highly luminous, of a purple colour, and in some parts an inch or more apart :—by a spark discharge at the prime conductor (1455.) single brushes may be obtained at pleasure. Discharge in the form of a brush is favoured by rarefaction of the air, in the same manner and for the same reason as discharge in the form of a spark (1375.) ; but in every case there is previous induction and charge through the dielectric, and polarity of its particles (1437.), the induction being, as in any other instance, alternately raised by the machine and lowered by the discharge. In certain experiments the rarefaction was increased to the utmost degree, and the opposed conducting surfaces brought as near together as possible without producing glow (1529.) : the brushes then contracted in their lateral dimensions, and recurred so rapidly as to form an apparently continuous arc of light from metal to metal. Still the discharge could be observed to intermit (1427.), so that even under these high conditions, induction preceded each single brush, and the tense polarized condition of the contiguous particles was a necessary preparation for the discharge itself.

1452. The brush form of disruptive discharge may be obtained not only in air and gases, but also in much denser media. I procured it in *oil of turpentine* from the end of a wire going through a glass tube into the fluid contained in a metal vessel. The brush was small and very difficult to obtain ; the

ramifications were simple, and stretched out from each other, diverging very much. The light was exceedingly feeble, a perfectly dark room being required for its observation. When a few solid particles, as of dust or silk, were in the liquid, the brush was produced with much greater facility.

1453. The running together or coalescence of different lines of discharge (1412.) is very beautifully shown in the brush in air. This point may present a little difficulty to those who are not accustomed to see in every discharge an equal exertion of power in opposite directions, a positive brush being considered by such (perhaps in consequence of the common phrase *direction of a current*) as indicating a breaking forth in different directions of the original force, rather than a tendency to convergence and union in one line of passage. But the ordinary case of the brush may be compared, for its illustration, with that in which, by holding the knuckle opposite to highly excited glass, a discharge occurs, the ramifications of a brush then leading from the glass and converging into a spark on the knuckle. Though a difficult experiment to make, it is possible to obtain discharge between highly excited shell-lac and the excited glass of a machine: when the discharge passes, it is, from the nature of the charged bodies, brush at each end and spark in the middle, beautifully illustrating that tendency of discharge to facilitate like action, which I have described in a former page (1418.).

1454. The brush has *specific characters* in different gases, indicating a relation to the particles of these bodies even in a stronger degree than the spark (1422. 1423.). This effect is in strong contrast with the non-variation caused by the use of different substances as *conductors* from which the brushes are to originate. Thus, using such bodies as wood, card, charcoal, nitre, citric acid, oxalic acid, oxide of lead, chloride of lead, carbonate of potassa, potassa fusa, strong solution of potash, oil of vitriol, sulphur, sulphuret of antimony, and hæmatite, no variation in the character of the brushes was obtained, except that (dependent upon their effect as better or worse conductors) of causing discharge with more or less readiness and quickness from the machine*.

* Exception must, of course, be made of those cases where the root of the brush, becoming a spark, causes a little diffusion or even decomposition of the matter there, and so gains more or less of a particular colour at that part.

1455. The following are a few of the effects I observed in different gases at the positively charged surfaces, and with atmospheres varying in their pressure. The general effect of rarefaction was the same for all the gases : at first, sparks passed ; these gradually were converted into brushes, which became larger and more distinct in their ramifications, until, upon further rarefaction, the latter began to collapse and draw in upon each other, till they formed a stream across from conductor to conductor : then a few lateral streams shot out towards the glass of the vessel from the conductors ; these became thick and soft in appearance, and were succeeded by the full constant glow which covered the discharging wire. The phenomena varied with the size of the vessel (1477.), the degree of rarefaction, and the discharge of electricity from the machine. When the latter was in successive sparks, they were most beautiful, the effect of a spark from a small machine being equal to, and often surpassing, that produced by the *constant* discharge of a far more powerful one.

1456. *Air*.—Fine positive brushes are easily obtained in air at common pressures, and possess the well-known purplish light. When the air is rarefied, the ramifications are very long, filling the globe (1477.) ; the light is greatly increased, and is of a beautiful purple colour, with an occasional rose tint in it.

1457. *Oxygen*.—At common pressures, the brush is very close and compressed, and of a dull whitish colour. In rarefied oxygen, the form and appearance are better, the colour somewhat purplish, but all the characters very poor compared to those in air.

1458. *Nitrogen* gives brushes with great facility at the positive surface, far beyond any other gas I have tried : they are almost always fine in form, light, and colour, and in rarefied nitrogen are magnificent. They surpass the discharges in any other gas as to the quantity of light evolved.

1459. *Hydrogen*, at common pressures, gave a better brush than oxygen, but did not equal nitrogen ; the colour was greenish gray. In rarefied hydrogen, the ramifications were very fine in form and distinctness, but pale in colour, with a soft and velvety appearance, and not at all equal to those in nitrogen. In the rarest state of the gas, the colour of the light was a pale gray green.

1460. *Coal gas*.—The brushes were rather difficult to produce, the contrast with nitrogen being great in this respect. They were short and strong, generally of a greenish colour, and possessing much of the spark character: for, occurring on both the positive and negative terminations, often when there was a dark interval of some length between the two brushes, still the quick, sharp sound of the spark was produced, as if the discharge had been sudden through this gas, and partaking, in that respect, of the character of a spark. In rare coal gas, the brush forms were better, but the light very poor and the colour gray.

1461. *Carbonic acid gas* produces a very poor brush at common pressures, as regards either size, light, or colour; and this is probably connected with the tendency which this gas has to discharge the electricity as a spark (1422.). In rarefied carbonic acid, the brush is better in form, but weak as to light, being of a dull greenish or purplish hue, varying with the pressure and other circumstances.

1462. *Muriatic acid gas*.—It is very difficult to obtain the brush in this gas at common pressures. On gradually increasing the distance of the rounded ends, the sparks suddenly ceased when the interval was about an inch, and the discharge, which was still through the gas in the globe, was silent and dark. Occasionally a very short brush could for a few moments be obtained, but it quickly disappeared. Even when the intermitting spark current (1455.) from the machine was used, still I could only with difficulty obtain a brush, and that very short, though I used rods with rounded terminations (about 0.25 of an inch in diameter) which had before given them most freely in air and nitrogen. During the time of this difficulty with the muriatic gas, magnificent brushes were passing off from different parts of the machine into the surrounding air. On rarefying the gas, the formation of the brush was facilitated, but it was generally of a low squat form, very poor in light, and very similar on both the positive and negative surfaces. On rarefying the gas still more, a few large ramifications were obtained of a pale bluish colour, utterly unlike those in nitrogen.

1463. In all the gases, the different forms of disruptive dis-

charge may be linked together and gradually traced from one extreme to the other, *i. e.* from the spark to the glow (1405. 1526.), or, it may be, to a still further condition to be called dark discharge (1544—1560.); but it is nevertheless very surprising to see what a specific character each keeps whilst under the predominance of the general law. Thus, in muriatic acid, the brush is very difficult to obtain, and there comes in its place almost a dark discharge, partaking of the readiness of the spark action. Moreover, in muriatic acid, I have *never* observed the spark with any dark interval in it. In nitrogen, the spark readily changes its character into that of brush. In carbonic acid gas, there seems to be a facility to occasion spark discharge, whilst yet that gas is unlike nitrogen in the facility of the latter to form brushes, and unlike muriatic acid in its own facility to continue the spark. These differences add further force, first to the observations already made respecting the spark in various gases (1422. 1423.), and then, to the proofs deducible from it, of the relation of the electrical forces to the particles of matter.

1464. The peculiar characters of nitrogen in relation to the electric discharge (1422. 1458.) must, evidently, have an important influence over the form and even the occurrence of lightning. Being that gas which most readily produces coruscations, and, by them, extends discharge to a greater distance than any other gas tried, it is also that which constitutes four-fifths of our atmosphere; and as in atmospheric electrical phenomena, one, and sometimes both the inductive forces are resident on the particles of the air, which, though probably affected as to conducting power by the aqueous particles in it, cannot be considered as a good conductor; so the peculiar power possessed by nitrogen, to originate and effect discharge in the form of a brush or of ramifications, has, probably, an important relation to its electrical service in nature, as it most seriously affects the character and condition of the discharge when made. The whole subject of discharge from and through gases is of great interest, and, if only in reference to atmospheric electricity, deserves extensive and close experimental investigation.

Difference of discharge at the positive and negative conducting surfaces.

1465. I have avoided speaking of this well-known phenomenon more than was quite necessary, that I might bring together here what I have to say on the subject. When the brush discharge is observed in air at the positive and negative surfaces, there is a very remarkable difference, the true and full comprehension of which would, no doubt, be of the utmost importance to the physics of electricity; it would throw great light on our present subject, *i. e.* the molecular action of dielectrics under induction, and its consequences; and seems very open to, and accessible by, experimental inquiry.

1466. The difference in question used to be expressed in former times by saying, that a point charged positively gave brushes into the air, whilst the same point charged negatively gave a star. This is true only of bad conductors, or of metallic conductors charged intermittingly, or otherwise controlled by collateral induction. If metallic points project *freely* into the air, the positive and negative light upon them differ very little in appearance, and the difference can be observed only upon close examination.

1467. The effect varies exceedingly under different circumstances, but, as we must set out from some position, may perhaps be stated thus: if a metallic wire with a rounded termination in free air be used to produce the brushy discharge, then the brushes obtained when the wire is charged negatively are very poor and small, by comparison with those produced when the charge is positive. Or if a large metal ball connected with the electrical machine be charged *positively*, and a fine un-insulated point be gradually brought towards it, a star appears on the point when at a considerable distance, which, though it becomes brighter, does not change its form of a star until it is close up to the ball: whereas, if the ball be charged negatively, the point at a considerable distance has a star on it as before; but when brought nearer, (in my case to the distance of $1\frac{1}{2}$ inch,) a brush formed on it, extending to the negative ball; and when still nearer, (at $\frac{1}{8}$ of an inch distance,) the brush ceased, and bright sparks passed. These variations, I believe,

include the whole series of differences, and they seem to show at once, that the negative surface tends to retain its discharging character unchanged, whilst the positive surface, under similar circumstances, permits of great variation.

1468. There are several points in the character of the negative discharge to air which it is important to observe. A metal rod, 0·3 of an inch in diameter, with a rounded end projecting into the air, was charged negatively, and gave a short noisy brush (fig. 122.). It was ascertained both by sight (1427. 1433.) and sound (1431.), that the successive discharges were very rapid in their recurrence, being seven or eight times more numerous in the same period than those produced when the rod was charged positively to an equal degree. When the rod was positive, it was easy, by working the machine a little quicker, to replace the brush by a glow (1405. 1463.), but when it was negative no efforts could produce this change. Even by bringing the hand opposite the wire, the only effect was to increase the number of brush discharges in a given period, raising at the same time the sound to a higher pitch.

1469. A point opposite the negative brush exhibited a star, and as it was approximated caused the size and sound of the negative brush to diminish, and at last, to cease, leaving the negative end silent and dark, yet effective as to discharge.

1470. When the round end of a smaller wire (fig. 123.) was advanced towards the negative brush, it (becoming positive by induction) exhibited the quiet glow at 8 inches distance, the negative brush continuing. When nearer, the pitch of the sound of the negative brush rose, indicating quicker intermit- tences (1431.) ; still nearer the positive end threw off ramifi- cations and distinct brushes ; at the same time the negative brush contracted in its lateral directions and collected together, giving a peculiar narrow longish brush, in shape like a hair pen- cil, the two brushes existing at once, but very different in their form and appearance, and especially in the more rapid recur- rence of the negative discharges than of the positive. On using a smaller positive wire for the same experiment, the glow first appeared on it, and then the brush, the negative brush being affected at the same time ; and the two at one distance became exceedingly alike in appearance, and the sounds, I thought, were in unison ; at all events they were in harmony, so that the inter-

missions of discharge were either isochronous, or a simple ratio existed between the intervals. With a higher action of the machine, the wires being retained unaltered, the negative surface became dark and silent, and a glow appeared on the positive one. A still higher action changed the latter into a spark. Finer positive wires gave other variations of these effects, the description of which I must not allow myself to go into here.

1471. A thinner rod was now connected with the negative conductor in place of the larger one (1468.), its termination being gradually diminished to a blunt point, as in fig. 124; and it was beautiful to observe that, notwithstanding the variation of the brush, the same general order of effects was produced. The end gave a small sonorous negative brush, which the approach of the hand or a large conducting surface did not alter, until it was so near as to produce a spark. A fine point opposite to it was luminous at a distance; being nearer it did not destroy the light and sound of the negative brush, but only tended to have a brush produced on itself, which, at a still less distance, passed into a spark joining the two surfaces.

1472. When the distinct negative and positive brushes are produced simultaneously in relation to each other in air, the former almost always has a contracted form, as in fig. 125., very much indeed resembling the figure which the positive brush itself has when influenced by the lateral vicinity of positive parts acting by induction. Thus a brush issuing from a point in the re-entering angle of a positive conductor has the same compressed form (fig. 126.).

1473. The character of the negative brush is not affected by the chemical nature of the substances of the conductors (1454.) but only by their possession of the conducting power in a greater or smaller degree.

1474. Rarefaction of common air about a negative ball or blunt point facilitated the development of the negative brush, the effect being, I think, greater than on a positive brush, though great on both. Extensive ramifications could be obtained from a ball or end electrified negatively to the plate of the air-pump on which the jar containing it stood.

1475. A very important variation of the relative forms and conditions of the positive and negative brush takes place on varying the dielectric in which they are produced. The differ-

ence is so very great that it points to a specific relation of this form of discharge to the particular gas in which it takes place, and opposes the idea that gases are but obstructions to the discharge, acting one like another and merely in proportion to their pressure (1377.).

1476. In *air*, the superiority of the positive brush is well known (1467. 1472.). In *nitrogen*, it is as great or even greater than in air (1458.). In *hydrogen*, the positive brush loses a part of its superiority, not being so good as in nitrogen or air; whilst the negative brush does not seem injured (1459.). In *oxygen*, the positive brush is compressed and poor (1457); whilst the negative did not become less: the two were so alike that the eye frequently could not tell one from the other, and this similarity continued when the oxygen was gradually rarefied. In *coal gas*, the brushes are difficult of production as compared to nitrogen (1460.), and the positive not much superior to the negative in its character, either at common or low pressures. In *carbonic acid gas*, this approximation of character also occurred. In *muriatic acid gas*, the positive brush was very little better than the negative, and both difficult to produce (1462.) as compared with the facility in nitrogen or air.

1477. These experiments were made with rods of brass about a quarter of an inch thick having rounded ends, these being opposed in a glass globe 7 inches in diameter, containing the gas to be experimented with. The electric machine was used to communicate directly, sometimes the positive, and sometimes the negative, state, to the rod in connection with it.

1478. Thus we see that, notwithstanding there is a general difference in favour of the superiority of the positive brush over the negative, that difference is at its maximum in nitrogen and air; whilst in carbonic acid, muriatic acid, coal gas, and oxygen, it diminishes, and at last almost disappears. So that in this particular effect, as in all others yet examined, the evidence is in favour of that view which refers the results to a direct relation of the electric forces with the molecules of the matter concerned in the action (1421. 1423. 1463.). Even when special phenomena arise under the operation of the general law, the theory adopted seems fully competent to meet the case.

1479. Before I proceed further in tracing the probable

cause of the difference between the positive and negative brush discharge, I wish to know the results of a few experiments which are in course of preparation: and thinking this Series of Researches long enough, I shall here close it with the expectation of being able in a few weeks to renew the inquiry, and entirely redeem my pledge (1306.).

*Royal Institution,
December 23rd, 1837.*

THIRTEENTH SERIES.

§ 18. *On Induction (continued).* ¶ ix. *Disruptive discharge (continued)—Peculiarities of positive and negative discharge either as spark or brush—Glow discharge—Dark discharge.* ¶ x. *Convection, or carrying discharge.* ¶ xi. *Relation of a vacuum to electrical phenomena.* § 19. *Nature of the electrical current.*

Received February 22,—Read March 15, 1838.

¶ ix. *Disruptive discharge (continued).*

1480. LET us now direct our attention to the general difference of the positive and negative disruptive discharge, with the object of tracing, as far as possible, the cause of that difference, and whether it depends on the charged conductors principally, or on the interposed dielectric; and as it appears to be great in air and nitrogen (1476.), let us observe the phenomena in air first.

1481. The general case is best understood by a reference to surfaces of considerable size rather than to points, which involve (as a secondary effect) the formation of currents (1562.). My investigation, therefore, was carried on with balls and terminations of different diameters, and the following are some of the principal results.

1482. If two balls of very different dimensions, as for instance one half an inch, and the other three inches, in diameter, be arranged at the ends of rods so that either can be electrified by a machine and made to discharge by sparks to the other, which is at the same time uninsulated; then, as is well known, far longer sparks are obtained when the small ball is positive and the large ball negative, than when the small ball is negative and the large ball positive. In the former case, the sparks are 10 or 12 inches in length; in the latter, an inch or an inch and a half only.

1483. But previous to the description of further experi-

ments, I will mention two words, for which with many others I am indebted to a friend, and which I think it would be expedient to introduce and use. It is important in ordinary inductive action, to distinguish at which charged surface the induction originates and is sustained: *i. e.* if two or more metallic balls, or other masses of matter, are in inductive relation, to express which are charged originally, and which are brought by them into the opposite electrical condition. I propose to call those bodies which are originally charged, *inductric* bodies; and those which assume the opposite state, in consequence of the induction, *inducteous* bodies. This distinction is not needful because there is any difference between the sums of the *inductric* and the *inducteous* forces; but principally because, when a ball A is inductric, it not merely brings a ball B, which is opposite to it, into an inducteous state, but also many other surrounding conductors, though some of them may be a considerable distance off, and the consequence is, that the balls do not bear the same precise relation to each other when, first one, and then the other, is made the inductric ball; though, in each case, the *same ball* be made to assume the *same state*.

1484. Another liberty which I may also occasionally take in language I will explain and limit. It is that of calling a particular spark or brush, *positive* or *negative*, according as it may be considered as *originating* at a positive or a negative surface. We speak of the brush as positive or negative when it shoots out from surfaces previously in those states; and the experiments of Mr. Wheatstone go to prove that it *really begins* at the charged surface, and from thence extends into the air (1437. 1438.) or other dielectric. According to my view, *sparks* also originate or are determined at one particular spot (1370.), namely, that where the tension first rises up to the maximum degree; and when this can be determined, as in the simultaneous use of large and small balls, in which case the discharge begins or is determined by the latter, I would call that discharge which passes *at once*, a positive spark, if it was at the positive surface that the maximum intensity was first obtained; or a negative spark, if that necessary intensity was first obtained at the negative surface.

1485. An apparatus was arranged, as in fig. 129 (Plate VIII.) : A and B, were brass balls of very different diameters attached to metal rods, moving through sockets on insulating pillars, so that the distance between the balls could be varied at pleasure. The large ball A, 2 inches in diameter, was connected with an insulated brass conductor, which could be rendered positive or negative directly from a cylinder machine : the small ball B, 0.25 of an inch in diameter, was connected with a discharging train (292.) and perfectly uninsulated. The brass rods sustaining the balls were 0.2 of an inch in thickness.

1486. When the large ball was *positive* and inductive (1483.), negative sparks occurred until the interval was 0.49 of an inch ; then mixed brush and spark between that and 0.51 ; and from 0.52 and upwards, negative brush alone. When the large ball was made *negative* and inductive, then positive spark alone occurred until the interval was as great as 1.15 inches ; spark and brush from that up to 1.55 ; and to have the positive brush alone, it required an interval of at least 1.65 inches.

1487. The balls A and B were now changed for each other. Then making the small ball B inductive *positively*, the positive sparks alone continued only up to 0.67 ; spark and brush occurred from 0.68 up to 0.72 ; and positive brush alone from 0.74 and upwards. Rendering the small ball B inductive and *negative*, negative sparks alone occurred up to 0.40 ; then spark and brush at 0.42 ; whilst from 0.44 and upwards the noisy negative brush alone took place.

1488. We thus find a great difference as the balls are rendered inductive or inductuous ; the small ball rendered *positive* inductuously giving a spark nearly twice as long as that produced when it was charged positive inductively, and a corresponding difference, though not, under the circumstances, to the same extent, was manifest, when it was rendered *negative*.*

1489. Other results are, that the small ball rendered positive gives a much longer spark than when it is rendered negative, and that the small ball rendered negative gives a brush

* For similar experiments on different gases, see 1518.—*Dec.* 1838,

more readily than when positive, in relation to the effect produced by increasing the distance between the two balls.

1490. When the interval was below 0.4 of an inch, so that the small ball should give sparks, whether positive or negative, I could not observe that there was any constant difference, either in their ready occurrence or the number which passed in a given time. But when the interval was such that the small ball when negative gave a brush, then the discharges from it, as separate negative brushes, were far more numerous than the corresponding discharges from it when rendered positive, whether those positive discharges were as sparks or brushes.

1491. It is, therefore, evident that, when a ball is discharging electricity in the form of brushes, the brushes are far more numerous, and each contains or carries off far less electric force when the electricity so discharged is negative, than when it is positive.

1492. In all such experiments as those described, the point of change from spark to brush is very much governed by the working state of the electrical machine and the size of the conductor connected with the discharging ball. If the machine be in strong action and the conductor large, so that much power is accumulated quickly for each discharge, then the interval is greater at which the sparks are replaced by brushes; but the general effect is the same.*

1493. These results, though indicative of very striking and peculiar relations of the electric force or forces, do not show the relative degrees of charge which the small ball acquires before discharge occurs, *i. e.* they do not tell whether it acquires a higher condition in the negative, or in the positive state, immediately preceding that discharge. To illustrate this important point I arranged two places of discharge as represented, fig. 130. A and D are brass balls 2 inches in diameter, B and C are smaller brass balls 0.25 of an inch in diameter; the forks L and R supporting them were of brass wire 0.2 of an inch in diameter: the space between the large and small ball on the same fork was 5 inches, that the two places of discharge *n* and *o* might be sufficiently removed from each other's influence.

* For similar experiments in different gases, see 1510—1517.—*Dec.* 1838.

The fork L was connected with a projecting cylindrical conductor, which could be rendered positive or negative at pleasure, by an electrical machine, and the fork R was attached to another conductor, but thrown into an uninsulated state by connection with a discharging train (292.). The two intervals or places of discharge n and o could be varied at pleasure, their extent being measured by the occasional introduction of a diagonal scale. It is evident, that, as the balls A and B connected with the same conductor are always charged at once, and that discharge may take place to either of the balls connected with the discharging train, the intervals of discharge n and o may be properly compared to each other, as respects the influence of large and small balls when charged positively and negatively in air.

1494. When the intervals n and o were each made = 0.9 of an inch, and the balls A and B inductive *positively*, the discharge was all at n from the small ball of the conductor to the large ball of the discharging train, and mostly by positive brush, though once by a spark. When the balls A and B were made inductric *negatively*, the discharge was still from the same small ball, at n , by a constant negative brush.

1495. I diminished the intervals n and o to 0.6 of an inch. When A and B were inductric *positively*, all the discharge was at n as a positive brush: when A and B were inductric *negatively*, still all the discharge was at n , as a negative brush.

1496. The facility of discharge at the positive and negative small balls, therefore, did not appear to be very different. If a difference had existed, there were always two small balls, one in each state, that the discharge might happen at that most favourable to the effect. The only difference was, that one was in the inductric, and the other in the inductive state, but whichever happened for the time to be in that state, whether positive or negative, had the advantage.

1497. To counteract this interfering influence, I made the interval $n = 0.79$ and interval $o = 0.58$ of an inch. Then, when the balls A and B were *inductric positive*, the discharge was about equal at both intervals. When, on the other hand, the balls A and B were inductric *negative*, there was discharge, still at both, but most at n , as if the small ball *negative* could discharge a little easier than the same ball *positive*.

1498. The small balls and terminations used in these and similar experiments may very correctly be compared, in their action, to the same balls and ends when electrified in free air at a much greater distance from conductors, than they were in those cases from each other. In the first place, the discharge, even when as a spark, is, according to my view, determined, and, so to speak, begins at a spot on the surface of the small ball (1374.), occurring when the intensity there has risen up to a certain maximum degree (1370.); this determination of discharge at a particular spot first, being easily traced from the spark into the brush, by increasing the distance, so as, at last, even to render the time evident which is necessary for the production of the effect (1436. 1438.). In the next place, the large balls which I have used might be replaced by larger balls at a still greater distance, and so, by successive degrees, may be considered as passing into the sides of the rooms; these being under general circumstances the inducteous bodies, whilst the small ball rendered either positive or negative is the inductric body.

1499. But, as has long been recognised, the small ball is only a blunt end, and, electrically speaking, a point only a small ball; so that when a point or blunt end is throwing out its brushes into the air, it is acting exactly as the small balls have acted in the experiments already described, and by virtue of the same properties and relations.

1500. It may very properly be said with respect to the experiments, that the large negative ball is as essential to the discharge as the small positive ball, and also that the large negative ball shows as much superiority over the large positive ball (which is inefficient in causing a spark from its opposed small negative ball) as the small positive ball does over the small negative ball; and probably when we understand the real cause of the difference, and refer it rather to the condition of the particles of the dielectric than to the sizes of the conducting balls, we may find much importance in such an observation. But for the present, and whilst engaged in investigating the point, we may admit, what is the fact, that the forces are of higher intensity at the surfaces of the smaller balls than at those of the larger (1372. 1374.); that the former, therefore, determine the discharge, by first rising up to that exalted con-

dition which is necessary for it; and that, whether brought to this condition by induction towards the walls of a room or the large balls I have used, these may fairly be compared one with the other in their influence and actions.

1501. The conclusions I arrive at are: first, that when two equal small conducting surfaces equally placed in air are electrified, one positively and the other negatively, that which is negative can discharge to the air at a tension a little lower than that required for the positive ball: second, that when discharge does take place, much more passes at each time from the positive than from the negative surface (1491.). The last conclusion is very abundantly proved by the optical analysis of the positive and negative brushes already described (1468.), the latter set of discharges being found to recur five or six times oftener than the former*.

1502. If, now, a small ball be made to give brushes or brushy sparks by a powerful machine, we can, in some measure, understand and relate the difference perceived when it is rendered positive or negative. It is known to give when positive a much larger and more powerful spark than when negative, and with greater facility (1482.); in fact, the spark, although it takes away so much more electricity at once, commences at a tension higher only in a small degree, if at all. On the other hand, if rendered negative, though discharge may commence at a lower degree, it continues but for a very short period, very little electricity passing away each time. These circumstances are directly related; for the extent to which the positive spark can reach, and the size and extent of the positive brush, are consequences of the capability which exists of much electricity passing off at one discharge from the positive surface (1468. 1501.).

1503. But to refer these effects only to the form and size of the conductor, would, according to my notion of induction, be a very imperfect mode of viewing the whole question (1523. 1600.). I apprehend that the effects are due altogether to the mode in which the particles of the interposed dielectric polarize, and I have already given some experimental indications of

* A very excellent mode of examining the relation of small positive and negative surfaces would be by the use of drops of gum water, solutions, or other liquids. See onwards (1581. 1593.).

the differences presented by different electrics in this respect (1475. 1476.). The modes of polarization, as I shall have occasion hereafter to show, may be very diverse in different dielectrics. With respect to common air, what seems to be the consequence of a superiority in the positive force at the surface of the small ball, may be due to the more exalted condition of the negative polarity of the particles of air, or of the nitrogen in it (the negative part being, perhaps, more compressed, whilst the positive part is more diffuse, or *vice versá* (1687. &c.)) ; for such a condition could determine certain effects at the positive ball which would not take place to the same degree at the negative ball, just as well as if the positive ball had possessed some special and independent power of its own.

1504. The opinion, that the effects are more likely to be dependent upon the dielectric than the ball, is supported by the character of the two discharges. If a small positive ball be throwing off brushes with ramifications ten inches long, how can the ball affect that part of a ramification which is five inches from it? Yet the portion beyond that place has the same character as that preceding it, and no doubt has that character impressed by the same general principle and law. Looking upon the action of the contiguous particles of a dielectric as fully proved, I see, in such a ramification, a propagation of discharge from particle to particle, each doing for the one next it what was done for it by the preceding particle, and what was done for the first particle by the charged metal against which it was situated.

1505. With respect to the general condition and relations of the positive and negative brushes in dense or rare air, or in other media and gases, if they are produced at different times and places, they are of course independent of each other. But when they are produced from opposed ends or balls at the same time, in the same vessel of gas (1470. 1477.), they are frequently related ; and circumstances may be so arranged that they shall be isochronous, occurring in equal numbers in equal times ; or shall occur in multiples, *i. e.* with two or three negatives to one positive ; or shall alternate, or be quite irregular. All these variations I have witnessed ; and when it is considered that the air in the vessel, and also the glass of the vessel, can

take a momentary charge, it is easy to comprehend their general nature and cause.

1506. Similar experiments to those in air (1485. 1493.) were made in different gases, the results of which I will describe as briefly as possible. The apparatus is represented fig. 131., consisting of a bell-glass eleven inches in diameter at the widest part, and ten and a half inches high up to the bottom of the neck. The balls are lettered, as in fig. 130., and are in the same relation to each other; but A and B were on separate sliding wires, which, however, were generally joined by a cross wire, *w*, above, and that connected with the brass conductor, which received its positive or negative charge from the machine. The rods of A and B were graduated at the part moving through the stuffing-box, so that the application of a diagonal scale applied there, told what was the distance between these balls and those beneath them. As to the position of the balls in the jar, and their relation to each other, C and D were three and a quarter inches apart, their height above the pump plate five inches, and the distance between any of the balls and the glass of the jar one inch and three quarters at least, and generally more. The balls A and D were two inches in diameter, as before (1493.); the balls B and C only 0.15 of an inch in diameter.

Another apparatus was occasionally used in connection with that just described, being an open discharger (fig. 132.), by which a comparison of the discharge in air and that in gases could be obtained. The balls E and F, each 0.6 of an inch in diameter, were connected with sliding rods and other balls, and were insulated. When used for comparison, the brass conductor was associated at the same time with the balls A and B of figure 131 and ball E of this apparatus (fig. 132); whilst the balls C, D and F were connected with the discharging train.

1507. I will first tabulate the results as to the *restraining power* of the gases over discharge. The balls A and C (fig. 131.) were thrown out of action by distance, and the effects at B and D, or the interval *n* in the gas, compared with those at the interval *p* in the air, between E and F (fig. 132.). The Table sufficiently explains itself. It will be understood that all discharge was in the air, when the interval there was less

than that expressed in the first or third columns of figures ; and all the discharge in the gas, when the interval in air was greater than that in the second or fourth column of figures. At intermediate distances the discharge was occasionally at both places, *i. e.* sometimes in the air, sometimes in the gas.

Constant interval <i>n</i> between B and D = 1 inch.	Interval <i>p</i> in parts of an inch.			
	When the small ball B was inductive and <i>positive</i> the discharge was all		When the small ball B was inductive and <i>negative</i> the discharge was all	
	at <i>p</i> in air before.	at <i>n</i> in the gas after.	at <i>p</i> in air before.	at <i>n</i> in the gas after.
In Air	$p =$ 0.40	$p =$ 0.50	$p =$ 0.28	$p =$ 0.33
In Nitrogen	0.30	0.65	0.31	0.40
In Oxygen	0.33	0.52	0.27	0.30
In Hydrogen	0.20	0.40	0.22	0.24
In Coal gas	0.20	0.90	0.20	0.27
In Carbonic acid	0.64	1.30	0.30	0.45

1508. These results are the same generally, as far as they go, as those of the like nature in the last series (1388.), and confirm the conclusion that different gases restrain discharge in very different proportions. They are probably not so good as the former ones, for the glass jar not being varnished, acted irregularly, sometimes taking a certain degree of charge as a non-conductor, and at other times acting as a conductor in the conveyance and derangement of that charge. Another cause of difference in the ratios is, no doubt, the relative sizes of the discharge balls in air; in the former case they were of very different size, here they were alike.

1509. In future experiments intended to have the character of accuracy, the influence of these circumstances ought to be ascertained, and, above all things, the gases themselves ought to be contained in vessels of metal, and not of glass.

1510. The next set of results are those obtained when the intervals *n* and *o* (fig. 131.) were made equal to each other, and relate to the greater facility of discharge at the small ball, when rendered positive or negative (1493.).

1511. In *air*, with the intervals = 0.4 of an inch, A and B being inductive and positive, discharge was nearly equal at *n* and *o*; when A and B were inductive and negative, the discharge was mostly at *n* by negative brush. When the intervals

were = 0·8 of an inch, with A and B inductric positively, all discharge was at n by positive brush; with A and B inductric negatively, all the discharge was at n by a negative brush. It is doubtful, therefore, from these results, whether the negative ball has any greater facility than the positive.

1512. *Nitrogen*.—Intervals n and o = 0·4 of an inch: A, B inductric positive, discharge at both intervals, most at n , by positive sparks; A, B inductric negative, discharge equal at n and o . The intervals made = 0·8 of an inch: A, B inductric positive, discharge all at n by positive brush; A, B inductric negative, discharge most at o by positive brush. In this gas, therefore, though the difference is not decisive, it would seem that the positive small ball caused the most ready discharge.

1513. *Oxygen*.—Intervals n and o = 0·4 of an inch: A, B inductric positive, discharge nearly equal; inductric negative, discharge mostly at n by negative brush. Made the intervals = 0·8 of an inch: A, B inductric positive, discharge both at n and o ; inductric negative, discharge all at o by negative brush. So here the negative small ball seems to give the most ready discharge.

1514. *Hydrogen*.—Intervals n and o = 0·4 of an inch: A, B inductric positive, discharge nearly equal; inductric negative, discharge mostly at o . Intervals = 0·8 of an inch: A and B inductric positive, discharge mostly at n , as positive brush; inductric negative, discharge mostly at o , as positive brush. Here the positive discharge seems most facile.

1515. *Coal gas*.— n and o = 0·4 of an inch: A, B inductric positive, discharge nearly all at o by negative spark: A, B inductric negative, discharge nearly all at n by negative spark. Intervals = 0·8 of an inch, and A, B inductric positive, discharge mostly at o by negative brush: A, B inductric negative, discharge all at n by negative brush. Here the negative discharge most facile.

1516. *Carbonic acid gas*.— n and o = 0·4 of an inch: A, B inductric positive, discharge nearly all at o , or negative: A, B inductric negative, discharge nearly all at n , or negative. Intervals = 0·8 of an inch: A, B inductric positive, discharge mostly at o , or negative: A, B inductric negative, discharge all at n , or negative. In this case the negative had a decided advantage in facility of discharge.

1517. Thus, if we may trust this form of experiment, the

negative small ball has a decided advantage in facilitating disruptive discharge over the positive small ball in some gases, as in carbonic acid gas and coal gas, (1399.), whilst in others that conclusion seems more doubtful; and in others, again, there seems a probability that the positive small ball may be superior. All these results were obtained at very nearly the same pressure of the atmosphere.

1518. I made some experiments in these gases whilst in the air jar (fig. 131.), as to the change from spark to brush, analogous to those in the open air already described (1486. 1487.). I will give, in a Table, the results as to when brush began to appear mingled with the spark; but the after results were so varied, and the nature of the discharge in different gases so different, that to insert the results obtained without further investigation, would be of little use. At intervals less than those expressed the discharge was always by spark.

	Discharge between balls B and D.		Discharge between balls A and C.	
	Small ball B inductric <i>pos.</i>	Small ball B inductric <i>neg.</i>	Large ball A inductric <i>pos.</i>	Large ball A inductric <i>neg.</i>
Air	0.55	0.30	0.40	0.75
Nitrogen	0.30	0.40	0.52	0.41
Oxygen	0.70	0.30	0.45	0.32
Hydrogen	0.20	0.10		
Coal gas	0.13	0.30	0.30	0.14
Carbonic acid	0.82	0.43	1.60	{ above 1.80; had not space.

1519. It is to be understood that sparks occurred at much higher intervals than these; the table only expresses that distance beneath which all discharge was as spark. Some curious relations of the different gases to discharge are already discernible, but it would be useless to consider them until illustrated by further experiments.

1520. I ought not to omit noticing here, that Professor Belli of Milan has published a very valuable set of experiments on the relative dissipation of positive and negative electricity in the air*; he finds the latter far more ready, in this respect, than the former.

* Bibliothèque Universelle, 1836, September, p. 152.

1521. I made some experiments of a similar kind, but with sustained high charges ; the results were less striking than those of Signore Belli, and I did not consider them as satisfactory. I may be allowed to mention, in connexion with the subject, an interfering effect which embarrassed me for a long time. When I threw positive electricity from a given point into the air, a certain intensity was indicated by an electrometer on the conductor connected with the point, but as the operation continued this intensity rose several degrees ; then making the conductor negative with the same point attached to it, and all other things remaining the same, a certain degree of tension was observed in the first instance, which also gradually rose as the operation proceeded. Returning the conductor to the positive state, the tension was at first low, but rose as before ; and so also when again made negative.

1522. This result appeared to indicate that the point which had been giving off one electricity, was, by that, more fitted for a short time to give off the other. But on closer examination I found the whole depended upon the inductive reaction of that air, which being charged by the point, and gradually increasing in quantity before it, as the positive or negative issue was continued, diverted and removed a part of the inductive action of the surrounding wall, and thus apparently affected the powers of the point, whilst really it was the dielectric itself that was causing the change of tension.

1523. The results connected with the different conditions of positive and negative discharge will have a far greater influence on the philosophy of electrical science than we at present imagine, especially if, as I believe, they depend on the peculiarity and degree of polarized condition which the molecules of the dielectrics concerned acquire (1503. 1600.) Thus, for instance, the relation of our atmosphere and the earth within it, to the occurrence of spark or brush, must be especial and not accidental (1464.). It would not else consist with other meteorological phenomena, also of course dependent on the special properties of the air, and which being themselves in harmony the most perfect with the functions of animal and vegetable life, are yet restricted in their actions, not by loose regulations, but by laws the most precise.

1524. Even in the passage through air of the voltaic current

we see the peculiarities of positive and negative discharge at the two charcoal points; and if these discharges are made to take place simultaneously to mercury, the distinction is still more remarkable, both as to the sound and the quantity of vapour produced.

1525. It seems very possible that the remarkable difference recently observed and described by my friend Professor Daniell*, namely, that when a zinc and a copper ball, the same in size, were placed respectively in copper and zinc spheres, also the same in size, and excited by electrolytes or dielectrics of the same strength and nature, the zinc ball far surpassed the zinc sphere in action, may also be connected with these phenomena; for it is not difficult to conceive how the polarity of the particles shall be affected by the circumstance of the positive surface, namely the zinc, being the larger or the smaller of the two inclosing the electrolyte. It is even possible, that with different electrolytes or dielectrics the ratio may be considerably varied, or in some cases even inverted.

Glow discharge.

1526. That form of disruptive discharge which appears as a *glow* (1359. 1405.), is very peculiar and beautiful: it seems to depend on a quick and almost continuous charging of the air close to, and in contact with, the conductor.

1527. *Diminution of the charging surface* will produce it. Thus, when a rod 0·3 of an inch in diameter, with a rounded termination, was rendered positive in free air, it gave fine brushes from the extremity, but occasionally these disappeared, and a quiet phosphorescent continuous glow took their place, covering the whole of the end of the wire, and extending a very small distance from the metal into the air. With a rod 0·2 of an inch in diameter the glow was more readily produced. With still smaller rods, and also with blunt conical points, it occurred still more readily; and with a fine point I could not obtain the brush in free air, but only this glow. The positive glow and the positive star are, in fact, the same.

1528. *Increase of power in the machine* tends to produce the glow; for rounded terminations which will give only brushes

* Philosophical Transactions, 1838, p. 47.

when the machine is in weak action, will readily give the glow when it is in good order.

1529. *Rarefaction of the air* wonderfully favours the glow phenomena. A brass ball, two and a half inches in diameter, being made positively inductive in an air-pump receiver, became covered with glow over an area of two inches in diameter, when the pressure was reduced to 4·4 inches of mercury. By a little adjustment the ball could be covered all over with this light. Using a brass ball 1·25 inches in diameter, and making it inducteously positive by an inductive negative point, the phenomena, at high degrees of rarefaction, were exceedingly beautiful. The glow came over the positive ball, and gradually increased in brightness, until it was at last very luminous; and it also stood up like a low flame, half an inch or more in height. On touching the sides of the glass jar this lambent flame was affected, assumed a ring form, like a crown on the top of the ball, appeared flexible, and revolved with a comparatively slow motion, *i. e.* about four or five times in a second. This ring-shape and revolution are beautifully connected with the mechanical currents (1576.) taking place within the receiver. These glows in rarefied air are often highly exalted in beauty by a spark discharge at the conductor (1551. *Note.*).

1530. To obtain a *negative glow* in air at common pressures is difficult. I did not procure it on the rod 0·3 of an inch in diameter by my machine, nor on much smaller rods; and it is questionable as yet, whether, even on fine points, what is called the negative star is a very reduced and minute, but still intermitting brush, or a glow similar to that obtained on a positive point.

1531. In rarefied air the negative glow can easily be obtained. If the rounded ends of two metal rods, about 0·2 of an inch in diameter, are introduced into a globe or jar (the air within being rarefied), and being opposite to each other, are about four inches apart, the glow can be obtained on both rods, covering not only the ends, but an inch or two of the part behind. On using *balls* in the air-pump jar, and adjusting the distance and exhaustion, the negative ball could be covered with glow, whether it were the inductive or the inducteous surface.

1532. When rods are used it is necessary to be aware that, if placed concentrically in the jar or globe, the light on one rod

is often reflected by the sides of the vessel on to the other rod, and makes it apparently luminous, when really it is not so. This effect may be detected by shifting the eye at the time of observation, or avoided by using blackened rods.

1533. It is curious to observe the relation of *glow*, *brush*, and *spark* to each other, as produced by positive or negative surfaces; thus, beginning with spark discharge, it passes into brush much sooner when the surface at which the discharge commences (1484.) is negative, than it does when positive; but proceeding onwards in the order of change, we find that the positive brush passes into *glow* long before the negative brush does. So that, though each presents the three conditions in the same general order, the series are not precisely the same. It is probable that, when these points are minutely examined, as they must be shortly, we shall find that each different gas or dielectric presents its own peculiar results, dependent upon the mode in which its particles assume polar electric condition.

1534. The glow occurs in all gases in which I have looked for it. These are air, nitrogen, oxygen, hydrogen, coal gas, carbonic acid, muriatic acid, sulphurous acid and ammonia. I thought also that I obtained it in oil of turpentine, but if so it was very dull and small.

1535. The glow is always accompanied by a wind proceeding either directly out from the glowing part, or directly towards it; the former being the most general case. This takes place even when the glow occurs upon a ball of considerable size: and if matters be so arranged that the ready and regular access of air to a part exhibiting the glow be interfered with or prevented, the glow then disappears.

1536. I have never been able to analyse or separate the glow into visible elementary intermitting discharges (1427. 1433.), nor to obtain the other evidence of intermitting action, namely an audible sound (1431.). The want of success, as respects trials made by ocular means, may depend upon the large size of the glow preventing the separation of the visible images: and, indeed, if it does intermit, it is not likely that all parts intermit at once with a simultaneous regularity.

1537. All the effects tend to show, that *glow* is due to a continuous charge or discharge of air; in the former case being accompanied by a current from, and in the latter by one to, the

place of the glow. As the surrounding air comes up to the charged conductor, on attaining that spot at which the tension of the particles is raised to the sufficient degree (1370. 1410.), it becomes charged, and then moves off, by the joint action of the forces to which it is subject; and, at the same time that it makes way for other particles to come and be charged in turn, actually helps to form that current by which they are brought into the necessary position. Thus, through the regularity of the forces, a constant and quiet result is produced; and that result is, the charging of successive portions of air, the production of a current, and of a continuous glow.

1538. I have frequently been able to make the termination of a rod, which, when left to itself, would produce a brush, produce in preference a glow, simply by aiding the formation of a current of air at its extremity; and, on the other hand, it is not at all difficult to convert the glow into brushes, by affecting the current of air (1574. 1579.) or the inductive action near it.

1539. The transition from glow, on the one hand, to brush and spark, on the other, and, therefore, their connexion, may be established in various ways. Those circumstances which tend to facilitate the charge of the air by the excited conductor, and also those which tend to keep the tension at the same degree notwithstanding the discharge, assist in producing the glow; whereas those which tend to resist the charge of the air or other dielectric, and those which favour the accumulation of electric force prior to discharge, which, sinking by that act, has to be exalted before the tension can again acquire the requisite degree, favour intermitting discharge, and, therefore, the production of brush or spark. Thus, rarefaction of the air, the removal of large conducting surfaces from the neighbourhood of the glowing termination, the presentation of a sharp point towards it, help to sustain or produce the glow: but the condensation of the air, the presentation of the hand or other large surface, the gradual approximation of a discharging ball, tend to convert the glow into brush or even spark. All these circumstances may be traced and reduced, in a manner easily comprehensible, to their relative power of assisting to produce, either a *continuous* discharge to the air, which gives the glow; or an *interrupted* one, which produces the brush, and, in a more exalted condition, the spark.

1540. The rounded end of a brass rod, 0·3 of an inch in diameter, was covered with a positive glow by the working of an electrical machine: on stopping the machine, so that the charge of the connected conductor should fall, the glow changed for a moment into brushes just before the discharge ceased altogether, illustrating the necessity for a certain high continuous charge, for a certain sized termination. Working the machine so that the intensity should be just low enough to give continual brushes from the end in free air, the approach of a fine point changed these brushes into a glow. Working the machine so that the termination presented a continual glow in free air, the gradual approach of the hand caused the glow to contract at the very end of the wire, then to throw out a luminous point, which, becoming a foot stalk (1426.) finally produced brushes with large ramifications. All these results are in accordance with what is stated above (1539.).

1541. Greasing the end of a rounded wire will immediately make it produce brushes instead of glow. A ball having a blunt point which can be made to project more or less beyond its surface, at pleasure, can be made to produce every gradation from glow, through brush, to spark.

1542. It is also very interesting and instructive to trace the transition from spark to glow, through the intermediate condition of stream, between ends in a vessel containing air more or less rarefied; but I fear to be prolix.

1543. All the effects show, that the glow is in its nature exactly the same as the luminous part of a brush or ramification, namely a charging of air; the only difference being, that the glow has a continuous appearance from the constant renewal of the same action in the same place, whereas the ramification is due to a momentary, independent and intermitting action of the same kind.

Dark discharge.

1544. I will now notice a very remarkable circumstance in the luminous discharge accompanied by negative glow, which may, perhaps, be correctly traced hereafter into discharges of much higher intensity. Two brass rods, 0·3 of an inch in diameter, entering a glass globe on opposite sides, had their ends

brought into contact, and the air about them very much rarefied. A discharge of electricity from the machine was then made through them, and whilst that was continued the ends were separated from each other. At the moment of separation a continuous glow came over the end of the negative rod, the positive termination remaining quite dark. As the distance was increased, a purple stream or haze appeared on the end of the positive rod, and proceeded directly outwards towards the negative rod; elongating as the interval was enlarged, but never joining the negative glow, there being always a short dark space between. This space, of about $\frac{1}{16}$ th or $\frac{1}{20}$ th of an inch, was apparently invariable in its extent and its position, relative to the negative rod; nor did the negative glow vary. Whether the negative end were inductive or inductiveous, the same effect was produced. It was strange to see the positive purple haze diminish or lengthen as the ends were separated, and yet this dark space and the negative glow remain unaltered (fig. 133.).

1545. Two balls were then used in a large air pump receiver, and the air rarefied. The usual transitions in the character of the discharge took place; but whenever the luminous stream, which appears after the spark and the brush have ceased, was itself changed into glow at the balls, the dark space occurred, and that whether the one or the other ball was made inductive, or positive, or negative.

1546. Sometimes when the negative ball was large, the machine in powerful action, and the rarefaction high, the ball would be covered over half its surface with glow, and then, upon a hasty observation, would seem to exhibit no dark space: but this was a deception, arising from the overlapping of the convex termination of the negative glow and the concave termination of the positive stream. More careful observation and experiment have convinced me, that when the negative glow occurs, it never visibly touches the luminous part of the positive discharge, but that the dark space is always there.

1547. This singular separation of the positive and negative discharge, as far as concerns their luminous character, under circumstances which one would have thought very favourable to their coalescence, is probably connected with their differences when in the form of brush, and is perhaps even de-

pendent on the same cause. Further, there is every likelihood that the dark parts which occur in feeble sparks are also connected with these phenomena*. To understand them would be very important, for it is quite clear that in many of the experiments, indeed in all that I have quoted, discharge is taking place across the dark part of the dielectric to an extent quite equal to what occurs in the luminous part. This difference in the result would seem to imply a distinction in the modes by which the two electric forces are brought into equilibrium in the respective parts; and looking upon all the phenomena as giving additional proofs, that it is to the condition of the particles of the dielectric we must refer for the principles of induction and discharge, so it would be of great importance if we could know accurately in what the difference of action in the dark and the luminous parts consisted.

1548. The dark discharge through air (1552.), which in the case mentioned is very evident (1544.), leads to the inquiry, whether the particles of air are generally capable of effecting discharge from one to another without becoming luminous; and the inquiry is important, because it is connected with that degree of tension which is necessary to originate discharge (1368. 1370.). Discharge between *air and conductors* without luminous appearances are very common; and non-luminous discharges by carrying currents of air and other fluids (1562. 1595.) are also common enough: but these are not cases in point, for they are not discharges between insulating particles.

1549. An arrangement was made for discharge between two balls (1485.) (fig. 129.) but, in place of connecting the inductive ball directly with the discharging train, it was put in communication with the inside coating of a Leyden jar, and the discharging train with the outside coating. Then working the machine, it was found that whenever sonorous and luminous discharge occurred at the balls A B, the jar became charged; but that when these did not occur, the jar acquired no charge: and such was the case when small rounded terminations were used in place of the balls, and also in whatever manner they were arranged. Under these circumstances, therefore, discharge even between the air and conductors was always luminous.

* See Professor Johnson's experiments. Silliman's Journal, xxv. p. 57.

1550. But in other cases, the phenomena are such as to make it almost certain, that dark discharge can take place across air. If the rounded end of a metal rod, 0·15 of an inch in diameter, be made to give a good negative brush, the approach of a smaller end or a blunt point opposite to it will, at a certain distance, cause a diminution of the brush, and a glow will appear on the positive inductive wire, accompanied by a current of air passing from it. Now, as the air is being charged both at the positive and negative surfaces, it seems a reasonable conclusion, that the charged portions meet somewhere in the interval, and there discharge to each other, without producing any luminous phenomena. It is possible, however, that the air electrified positively at the glowing end may travel on towards the negative surface, and actually form that atmosphere into which the visible negative brushes dart, in which case dark discharge need not, of necessity, occur. But I incline to the former opinion, and think, that the diminution in size of the negative brush, as the positive glow comes on to the end of the opposed wire, is in favour of that view.

1551. Using rarefied air as the dielectric, it is very easy to obtain luminous phenomena as brushes, or glow, upon both conducting balls or terminations, whilst the interval is dark, and that, when the action is so momentary that I think we cannot consider currents as effecting discharge across the dark part. Thus if two balls, about an inch in diameter, and 4 or more inches apart, have the air rarefied about them, and are then interposed in the course of discharge, an interrupted or spark current being produced at the machine*, each termination may be made to show luminous phenomena, whilst more or less of the interval is quite dark. The discharge will pass as suddenly as a retarded spark (295. 334.), *i. e.* in an interval of time almost inappreciably small, and in such a case, I think it must have passed across the dark part as true disruptive discharge, and not by convection.

1552. Hence I conclude that dark disruptive discharge may occur (1547. 1550.) ; and also, that, in the luminous brush, the

* By spark current I mean one passing in a series of spark between the conductor of the machine and the apparatus: by a continuous current one that passes through metallic conductors, and in that respect without interruption at the same place.

visible ramifications may not show the full extent of the disruptive discharge (1444. 1452.), but that each may have a dark outside, enveloping, as it were, every part through which the discharge extends. It is probable, even, that there are such things as dark discharges analogous in form to the brush and the spark, but not luminous in any part (1445.).

1553. The occurrence of dark discharge in any case shows at how low a tension disruptive discharge may occur (1548.), and indicates that the light of the ultimate brush or spark is in no relation to the intensity required (1368. 1370.). So to speak, the discharge begins in darkness, and the light is a mere consequence of the quantity which, after discharge has commenced, flows to that spot and there finds its most facile passage (1418. 1435.). As an illustration of the growth generally of discharge, I may remark that, in the experiments on the transition in oxygen of the discharge from spark to brush (1518.), every spark was immediately preceded by a short brush.

1554. The phenomena relative to dark discharge in other gases, though differing in certain characters from those in air, confirm the conclusions drawn above. The two rounded terminations (1544.) (fig. 133.), were placed in *muriatic acid gas* (1445. 1463.) at the pressure of 6.5 inches of mercury, and a continuous machine current of electricity sent through the apparatus: bright sparks occurred until the interval was about or above an inch, when they were replaced by squat brushy intermitting glows upon both terminations, with a dark part between. When the current at the machine was in spark, then each spark caused a discharge across the muriatic acid gas, which, with a certain interval, was bright; with a larger interval, was straight across and flamy, like a very exhausted and sudden, but not a dense sharp spark; and with a still larger interval, produced a feeble brush on the inductive positive end, and a glow on the inductive negative end, the dark part being between (1544.); and at such times, the spark at the conductor, instead of being sudden and sonorous, was dull and quiet (334.).

1555. On introducing more muriatic acid gas, until the pressure was 29.97 inches, the same terminations gave bright sparks within at small distances; but when they were about an inch or more apart, the discharge was generally with very small

brushes and glow, and frequently with no light at all, though electricity had passed through the gas. Whenever the bright spark did pass through the muriatic acid gas at this pressure, it was bright throughout, presenting no dark or dull space.

1556. In *coal gas*, at common pressures, when the distance was about an inch, the discharge was accompanied by short brushes on the ends, and a dark interval of half an inch or more between them, notwithstanding the discharge had the sharp quick sound of a dull spark, and could not have depended in the dark part on *convection* (1562.).

1557. This gas presents several curious points in relation to the bright and dark parts of spark discharge. When bright sparks passed between the rod ends 0·3 of an inch in diameter (1544.), very sudden dark parts would occur next to the brightest portions of the spark. Again, with these ends and also with balls (1422.), the bright sparks would be sometimes red, sometimes green, and occasionally green and red in different parts of the same spark. Again, in the experiments described (1518.), at certain intervals a very peculiar pale, dull, yet sudden discharge would pass, which, though apparently weak, was very direct in its course, and accompanied by a sharp snapping noise, as if quick in its occurrence.

1558. *Hydrogen* frequently gave peculiar sparks, one part being bright red, whilst the other was a dull pale gray, or else the whole spark was dull and peculiar.

1559. *Nitrogen* presented a very remarkable discharge, between two balls of the respective diameters of 0·15 and 2 inches (1506. 1518.), the smaller one being rendered negative either directly or inductively. The peculiar discharge occurs at intervals between 0·42 and 0·68, and even at 1·4 inches when the large ball was inductive positively; it consisted of a little brushy part on the small negative ball, then a dark space, and lastly a dull straight line on the large positive ball (fig. 134.). The position of the dark space was very constant, and is probably in direct relation to the dark space described when negative glow was produced (1544.). When by any circumstance a bright spark was determined, the contrast with the peculiar spark described was very striking; for it always had a faint purple part, but the place of this part was constantly near the positive ball.

1560. Thus dark discharge appears to be decidedly established. But its establishment is accompanied by proofs that it occurs in different degrees and modes in different gases. Hence then another specific action, added to the many (1296. 1398. 1399. 1423. 1454. 1503.) by which the electrical relations of insulating dielectrics are distinguished and established, and another argument in favour of that molecular theory of induction, which is at present under examination*.

1561. What I have had to say regarding disruptive discharge has extended to some length, but I hope will be excused in consequence of the importance of the subject. Before concluding my remarks, I will again intimate in the form of a query, whether we have not reason to consider the tension or retention and after discharge in air or other insulating dielectrics, as the same thing with retardation and discharge in a metal wire, differing only, but almost infinitely, in degree (1334. 1336.). In other words, can we not, by a gradual chain of association, carry up discharge from its occurrence in air, through spermaceti and water, to solutions, and then on to chlorides, oxides and metals, without any essential change in its character; and, at the same time, connecting the insensible conduction of air, through muriatic acid gas and the dark discharge, with the better conduction of spermaceti, water, and the all but perfect conduction of the metals, associate the phenomena at both extremes? and may it not be, that the retardation and ignition of a wire are effects exactly correspondent in their nature to the retention of charge and spark in air? If so, here again the two extremes in property amongst dielectrics will be found to be in intimate relation, the whole difference probably depending upon the mode and degree in which their particles polarize under the influence of inductive actions (1338. 1603. 1610.).

¶ x. *Convection, or carrying discharge.*

1562. The last kind of discharge which I have to consider is that effected by the motion of charged particles from place to

* I cannot resist referring here by a note to Biot's philosophical view of the nature of the light of the electric discharge, *Annales de Chimie*, lxi. p. 321.

place. It is apparently very different in its nature to any of the former modes of discharge (1319.), but, as the result is the same, may be of great importance in illustrating, not merely the nature of discharge itself, but also of what we call the electric current. It often, as before observed, in cases of brush and glow (1440. 1535.), joins its effect to that of disruptive discharge, to complete the act of neutralization amongst the electric forces.

1563. The particles which being charged, then travel, may be either of insulating or conducting matter, large or small. The consideration in the first place of a large particle of conducting matter may perhaps help our conceptions.

1564. A copper boiler 3 feet in diameter was insulated and electrified, but so feebly, that dissipation by brushes or disruptive discharge did not occur at its edges or projecting parts in a sensible degree. A brass ball, 2 inches in diameter, suspended by a clean white silk thread, was brought towards it, and it was found that, if the ball was held for a second or two near any part of the charged surface of the boiler, at such distance (two inches more or less) as not to receive any direct charge from it, it became itself charged, although insulated the whole time; and its electricity was the *reverse* of that of the boiler.

1565. This effect was the strongest opposite the edges and projecting parts of the boiler, and weaker opposite the sides, or those extended portions of the surface which, according to Coulomb's results, have the weakest charge. It was very strong opposite a rod projecting a little way from the boiler. It occurred when the copper was charged negatively as well as positively: it was produced also with small balls down to 0.2 of an inch and less in diameter, and also with smaller charged conductors than the copper. It is, indeed, hardly possible in some cases to carry an insulated ball within an inch or two of a charged plane or convex surface without its receiving a charge of the contrary kind to that of the surface.

1566. This effect is one of induction between the bodies, not of communication. The ball, when related to the positive charged surface by the intervening dielectric, has its opposite sides brought into contrary states, that side towards the boiler being negative and the outer side positive. More inductive

action is directed towards it than would have passed across the same place if the ball had not been there, for several reasons ; amongst others, because, being a conductor, the resistance of the particles of the dielectric, which otherwise would have been there, is removed (1298.) ; and also, because the reacting positive surface of the ball being projected further out from the boiler than when there is no introduction of conducting matter, is more free therefore to act through the rest of the dielectric towards surrounding conductors, and so favours the exaltation of that inductive polarity which is directed in its course. It is, as to the exaltation of force upon its outer surface beyond that upon the inductive surface of the boiler, as if the latter were itself protuberant in that direction. Thus it acquires a state like, but higher than, that of the surface of the boiler which causes it ; and sufficiently exalted to discharge at its positive surface to the air, or to affect small particles, as it is itself affected by the boiler, and they flying to it, take a charge and pass off ; and so the ball, as a whole, is brought into the contrary inductive state. The consequence is, that, if free to move, its tendency, under the influence of all the forces, to approach the boiler is increased, whilst it at the same time becomes more and more exalted in its condition, both of polarity and charge, until at a certain distance, discharge takes place, it acquires the same state as the boiler, is repelled, and passing to that conductor most favourably circumstanced to discharge it, there resumes its first indifferent condition.

1567. It seems to me, that the manner in which inductive bodies affect uncharged floating or moveable conductors near them, is very frequently of this nature, and generally so when it ends in a carrying operation (1562. 1602.). The manner in which, whilst the dominant inductive body cannot give off its electricity to the air, the inductive body *can* effect the discharge of the same kind of force, is curious, and, in the case of elongated or irregularly shaped conductors, such as filaments or particles of dust, the effect will often be very ready, and the consequent attraction immediate.

1568. The effect described is also probably influential in causing those variations in spark discharge referred to in the last series (1386. 1390. 1391.): for if a particle of dust were drawn towards the axis of induction between the balls, it would

tend, whilst at some distance from that axis, to commence discharge at itself, in the manner described (1566.), and that commencement might so far facilitate the act (1417. 1420.) as to make the complete discharge, as spark, pass through the particle, though it might not be the shortest course from ball to ball. So also, with equal balls at equal distances, as in the experiments of comparison already described (1493. 1506.), a particle being between one pair of balls would cause discharge there in preference; or even if a particle were between each, difference of size or shape would give one for the time a predominance over the other.

1569. The power of particles of dust to carry off electricity in cases of high tension is well known, and I have already mentioned some instances of the kind in the use of the inductive apparatus (1201.). The general operation is very well shown by large light objects, as the toy called the electrical spider; or, if smaller ones are wanted for philosophical investigation, by the smoke of a glowing green wax taper, which, presenting a successive stream of such particles, makes their course visible.

1570. On using oil of turpentine as the dielectric, the action and course of small conducting carrying particles in it can be well observed. A few short pieces of thread will supply the place of carriers, and their progressive action is exceedingly interesting.

1571. A very striking effect was produced on oil of turpentine, which, whether it was due to the carrying power of the particles in it, or to any other action of them, is perhaps as yet doubtful. A portion of that fluid in a glass vessel had a large uninsulated silver dish at the bottom, and an electrified metal rod with a round termination dipping into it at the top. The insulation was very good, and the attraction and other phenomena striking. The rod end, with a drop of gum water attached to it, was then electrified in the fluid; the gum water soon spun off in fine threads, and was quickly dissipated through the oil of turpentine. By the time that four drops had in this way been commingled with a pint of the dielectric, the latter had lost by far the greatest portion of its insulating power; no sparks could be obtained in the fluid; and all the phenomena dependent upon insulation had sunk to a low degree. The fluid was very slightly turbid. Upon being filtered through

paper only, it resumed its first clearness, and now insulated as well as before. The water, therefore, was merely diffused through the oil of turpentine, not combined with or dissolved in it: but whether the minute particles acted as carriers, or whether they were not rather gathered together in the line of highest inductive tension (1350.), and there, being drawn into elongated forms by the electric forces, combined their effects to produce a band of matter having considerable conducting power, as compared with the oil of turpentine, is as yet questionable.

1572. The analogy between the action of solid conducting carrying particles and that of the charged particles of fluid insulating substances, acting as dielectrics, is very evident and simple; but in the latter case the result is, necessarily, currents in the mobile media. Particles are brought by inductive action into a polar state; and the latter, after rising to a certain tension (1370.), is followed by the communication of a part of the force originally on the conductor; the particles consequently become charged, and then, under the joint influence of the repellent and attractive forces, are urged towards a discharging place, or to that spot where these inductive forces are most easily compensated by the contrary inductive forces.

1573. Why a point should be so exceedingly favourable to the production of currents in a fluid insulating dielectric, as air, is very evident. It is at the extremity of the point that the intensity necessary to charge the air is first acquired (1374.); it is from thence that the charged particle recedes; and the mechanical force which it impresses on the air to form a current is in every way favoured by the shape and position of the rod, of which the point forms the termination. At the same time, the point, having become the origin of an active mechanical force, does, by the very act of causing that force, namely, by discharge, prevent any other part of the rod from acquiring the same necessary condition, and so preserves and sustains its own predominance.

1574. The very varied and beautiful phenomena produced by sheltering or enclosing the point, illustrate the production of the current exceedingly well, and justify the same conclu-

sions; it being remembered that in such cases the effect upon the discharge is of two kinds. For the current may be interfered with by stopping the access of fresh uncharged air, or retarding the removal of that which has been charged, as when a point is electrified in a tube of insulating matter closed at one extremity; or the *electric condition* of the point itself may be altered by the relation of other parts in its neighbourhood, also rendered electric, as when the point is in a metal tube, by the metal itself, or when it is in the glass tube, by a similar action of the charged parts of the glass, or even by the surrounding air which has been charged, and which cannot escape.

1575. Whenever it is intended to observe such inductive phenomena in a fluid dielectric as have a direct relation to, and dependence upon, the fluidity of the medium, such, for instance, as discharge from points, or attractions and repulsions, &c., then the mass of the fluid should be great, and in such proportion to the distance between the inductive and inductive surfaces as to include all the *lines of inductive force* (1369.) between them; otherwise, the effects of currents, attraction, &c., which are the resultants of all these forces, cannot be obtained. The phenomena which occur in the open air, or in the middle of a globe filled with oil of turpentine, will not take place in the same media if confined in tubes of glass, shell-lac, sulphur, or other such substances, though they be excellent insulating dielectrics; nor can they be expected; for in such cases, the polar forces, instead of being all dispersed amongst fluid particles, which tend to move under their influence, are now associated in many parts with particles that, notwithstanding their tendency to motion, are constrained by their solidity to remain quiescent.

1576. The varied circumstances under which, with conductors differently formed and constituted, currents can occur, all illustrate the same simplicity of production. A *ball*, if the intensity be raised sufficiently on its surface, and that intensity be greatest on a part consistent with the production of a current of air up to and off from it, will produce the effect like a point (1537.); such is the case whenever the glow occurs upon a ball, the current being essential to that phenomenon. If as large a sphere as can well be employed with the production of glow be used,

the glow will appear at the place where the current leaves the ball, and that will be the part directly opposite to the connection of the ball and rod which supports it; but by increasing the tension elsewhere, so as to raise it above the tension upon that spot, which can easily be effected inductively, then the place of the glow and the direction of the current will also change, and pass to that spot which for the time is most favourable for their production (1591.).

1577. For instance, approaching the hand towards the ball will tend to cause brush (1539.), but by increasing the supply of electricity the condition of glow may be preserved; then on moving the hand about from side to side the position of the glow will very evidently move with it.

1578. A point brought towards a glowing ball would at twelve or fourteen inches distance make the glow break into brush, but when still nearer glow was reproduced, probably dependent upon the discharge of wind or air passing from the point to the ball, and this glow was very obedient to the motion of the point, following it in every direction.

1579. Even a current of wind could affect the place of the glow; for a varnished glass tube being directed sideways towards the ball, air was sometimes blown through it at the ball, and sometimes not. In the former case, the place of the glow was changed a little, as if it were blown away by the current, and this is just the result which might have been anticipated. All these effects illustrate beautifully the general causes and relations, both of the glow and the current of air accompanying it (1574.)

1580. Flame facilitates the production of a current in the dielectric surrounding it. Thus, if a ball which would not occasion a current in the air have a flame, whether large or small, formed on its surface, the current is produced with the greatest ease; but not the least difficulty can occur in comprehending the effective action of the flame in this case, if its relation, as part of the surrounding dielectric, to the electrified ball, be but for a moment considered (1375. 1380.).

1581. Conducting fluid terminations, instead of rigid points, illustrate in a very beautiful manner the formation of the currents, with their effects and influence in exalting the conditions

under which they were commenced. Let the rounded end of a brass rod, 0·3 of an inch or thereabouts in diameter, point downwards in free air; let it be amalgamated, and have a drop of mercury suspended from it; and then let it be powerfully electrized. The mercury will present the phenomenon of *glow*; a current of air will rush along the rod, and set off from the mercury directly downwards; and the form of the metallic drop will be slightly effected, the convexity at a small part near the middle and lower part becoming greater, whilst it diminishes all round at places a little removed from this spot. The change is from the form of *a* (fig. 135.) to that of *b*, and is due almost, if not entirely, to the mechanical force of the current of air sweeping over its surface.

1582. As a comparative observation, let it be noticed, that a ball gradually brought towards it converts the glow into brushes, and ultimately sparks pass from the most projecting part of the mercury. A point does the same, but at much smaller distances.

1583. Take next a drop of strong solution of muriate of lime; being electrified, a part will probably be dissipated, but a considerable portion, if the electricity be not too powerful, will remain, forming a conical drop (fig. 136.), accompanied by a strong current. If glow be produced, the drop will be smooth on the surface. If a short low brush is formed, a minute tremulous motion of the liquid will be visible; but both effects coincide with the principal one to be observed, namely, the regular and successive charge of air, the formation of a wind or current, and the form given by that current to the fluid drop. If a discharge ball be gradually brought toward the cone, sparks will at last pass, and these will be from the apex of the cone to the approached ball, indicating a considerable degree of conducting power in this fluid.

1584. With a drop of water, the effects were of the same kind, and were best obtained when a portion of gum water or of syrup hung from a ball (fig. 137.) When the machine was worked slowly, a fine large quiet conical drop, with concave lateral outline, and a small rounded end, was produced, on which the glow appeared, whilst a steady wind issued, in a direction from the point of the cone, of sufficient force to depress the surface of uninsulated water held opposite to the termination. When the machine was worked more rapidly some of the water

was driven off; the smaller pointed portion left was roughish on the surface, and the sound of successive brush discharges was heard. With still more electricity, more water was dispersed; that which remained was elongated and contracted, with an alternating motion; a stronger brush discharge was heard, and the vibrations of the water and the successive discharges of the individual brushes were simultaneous. When water from beneath was brought towards the drop, it did not indicate the same regular strong contracted current of air as before; and when the distance was such that sparks passed, the water beneath was *attracted* rather than driven away, and the current of air *ceased*.

1585. When the discharging ball was brought near the drop in its first quiet glowing state (1582.), it converted that glow into brushes, and caused the vibrating motion of the drop. When still nearer, sparks passed, but they were always from the metal of the rod, over the surface of the water, to the point, and then across the air to the ball. This is a natural consequence of the deficient conducting power of the fluid (1584. 1585.).

1586. Why the drop vibrated, changing its form between the periods of discharging brushes, so as to be more or less acute at particular instants, to be most acute when the brush issued forth, and to be isochronous in its action, and how the quiet glowing liquid drop, on assuming the conical form, facilitated, as it were, the first action, are points, as to theory, so evident, that I will not stop to speak of them. The principal thing to observe at present is, the formation of the carrying current of air, and the manner in which it exhibits its existence and influence by giving form to the drop.

1587. That the drop, when of water, or a better conductor than water, is formed into a cone principally by the current of air, is shown amongst other ways (1594.) thus. A sharp point being held opposite the conical drop, the latter soon lost its pointed form; was retracted and became round; the current of air from it ceased, and was replaced by one from the point beneath, which, if the latter were held near enough to the drop, actually blew it aside, and rendered it concave in form.

1588. It is hardly necessary to say what happened with still worse conductors than water, as oil, or oil of turpentine; the

fluid itself was then spun out into threads and carried off, not only because the air rushing over its surface, helped to sweep it away, but also because its insulating particles assumed the same charged state as the particles of air, and, not being able to discharge to them in a much greater degree than the air particles themselves could do, were carried off by the same causes which urged these in their course. A similar effect with melted sealing-wax on a metal-point forms an old and well-known experiment.

1589. A drop of gum water in the exhausted receiver of the air-pump was not sensibly affected in its form when electrified. When air was let in, it began to show change of shape when the pressure was ten inches of mercury. At the pressure of fourteen or fifteen inches the change was more sensible, and as the air increased in density the effects increased, until they were the same as those in the open atmosphere. The diminished effect in the rare air I refer to the relative diminished energy of its current; that diminution depending, in the first place, on the lower electric condition of the electrified ball in the rarefied medium, and in the next, on the attenuated condition of the dielectric, the cohesive force of water in relation to rarefied air being something like that of mercury to dense air (1581.), whilst that of water in dense air may be compared to that of mercury in oil of turpentine (1597.).

1590. When a ball is covered with a thick conducting fluid, as treacle or syrup, it is easy by inductive action to determine the wind from almost any part of it (1577.); the experiment, which before was of rather difficult performance, being rendered facile in consequence of the fluid enabling that part, which at first was feeble in its action, to rise into an exalted condition by assuming a pointed form.

1591. To produce the current, the electric intensity must rise and continue at *one spot*, namely, at the origin of the current, higher than elsewhere, and then, air having a uniform and ready access, the current is produced. If no current be allowed (1574.), then discharge may take place by brush or spark. But whether it be by brush or spark, or wind, it seems very probable that the initial intensity or tension at which a particle of a given gaseous dielectric charges, or commences discharge,

is, under the conditions before expressed, always the same (1410.).

1592. It is not supposed that all the air which enters into motion is electrified; on the contrary, much that is not charged is carried on into the stream. The part which is really charged may be but a small proportion of that which is ultimately set in motion (1442.).

1593. When a drop of gum water (1584.) is made *negative*, it presents a larger cone than when made positive; less of the fluid is thrown off, and yet, when a ball is approached, sparks can hardly be obtained, so pointed is the cone, and so free the discharge. A point held opposite to it did not cause the retraction of the cone to such an extent as when it was positive. All the effects are so different from those presented by the positive cone, that I have no doubt such drops would present a very instructive method of investigating the difference of positive and negative discharge in air and other dielectrics (1480. 1501.).

1594. That I may not be misunderstood (1587.), I must observe here that I do not consider the cones produced as the result *only* of the current of air or other insulating dielectric over their surface. When the drop is of badly conducting matter, a part of the effect is due to the electrified state of the particles, and this part constitutes almost the whole when the matter is melted sealing-wax, oil of turpentine, and similar insulating bodies (1588.). But even when the drop is of good conducting matter, as water, solutions, or mercury, though the effect above spoken of will then be insensible (1607.), still it is not the mere current of air or other dielectric which produces all the change of form; for a part is due to those attractive forces by which the charged drop, if free to move, would travel along the line of strongest induction, and not being free to move, has its form elongated until the sum of the different forces tending to produce this form is balanced by the cohesive attraction of the fluid. The effect of the attractive forces are well shown when treacle, gum water, or syrup is used; for the long threads which spin out, at the same time that they form the axes of the currents of air, which may still be considered as determined at their points, are like flexible conductors, and

show by their directions in what way the attractive forces draw them.

1595. When the phenomena of currents are observed in dense insulating dielectrics, they present us with extraordinary degrees of mechanical force. Thus, if a pint of well-rectified and filtered (1571.) oil of turpentine be put into a glass vessel, and two wires be dipped into it in different places, one leading to the electrical machine, and the other to the discharging train, on working the machine the fluid will be thrown into violent motion throughout its whole mass, whilst at the same time it will rise two, three, or four inches up the machine wire, and dart off in jets from it into the air.

1596. If very clean uninsulated mercury be at the bottom of the fluid, and the wire from the machine be terminated either by a ball or a point, and also pass through a glass tube extending both above and below the surface of the oil of turpentine, the currents can be better observed, and will be seen to rush down the wire, proceeding directly from it towards the mercury, and there, diverging in all directions, will ripple its surface strongly, and mounting up at the sides of the vessel, will return to re-enter upon their course.

1597. A drop of mercury being suspended from an amalgamated brass ball, preserved its form almost unchanged in air (1581.) ; but when immersed in the oil of turpentine it became very pointed, and even particles of the metal could be spun out and carried off by the currents of the dielectric. The form of the liquid metal was just like that of the syrup in air (1584.) the point of the cone being quite as fine, though not so long. By bringing a sharp uninsulated point towards it, it could also be effected in the same manner as the syrup drop in air (1587.), though not so readily, because of the density and limited quantity of the dielectric.

1598. If the mercury at the bottom of the fluid be connected with the electrical machine, whilst a rod is held in the hand terminating in a ball three quarters of an inch, less or more, in diameter, and the ball be dipped into the electrified fluid, very striking appearances ensue. When the ball is raised again so as to be at a level nearly out of the fluid, large portions of the latter will seem to cling to it (fig. 138.). If it be raised higher, a column of the oil of turpentine will still connect it with that

in the basin below (fig. 139.). If the machine be excited into more powerful action, this will become more bulky, and may then also be raised higher, assuming the form (fig. 140); and all the time that these effects continue, currents and counter-currents, sometimes running very close together, may be observed in the raised column of fluid.

1599. It is very difficult to decide by sight the direction of the currents in such experiments as these. If particles of silk are introduced they cling about the conductors; but using drops of water and mercury the course of the fluid dielectric seems well indicated. Thus, if a drop of water be placed at the end of a rod (1571.) over the uninsulated mercury, it is soon swept away in particles streaming downwards towards the mercury. If another drop be placed on the mercury beneath the end of the rod, it is quickly dispersed in all directions in the form of streaming particles, the attractive forces drawing it into elongated portions, and the currents carrying them away. If a drop of mercury be hung from a ball used to raise a column of the fluid (1598.), then the shape of the drop seems to show currents travelling in the fluid in the direction indicated by the arrows (fig. 141.).

1600. A very remarkable effect is produced on these phenomena, connected with positive and negative charge and discharge, namely, that a ball charged positively raises a much higher and larger column of the oil of turpentine than when charged negatively. There can be no doubt that this is connected with the difference of positive and negative action already spoken of (1480. 1525.), and tends much to strengthen the idea that such difference is referable to the particles of the dielectric rather than to the charged conductors, and is dependent upon the mode in which these particles polarize (1503. 1523.).

1601. Whenever currents travel in insulating dielectrics they really effect discharge; and it is important to observe, though a very natural result, that it is indifferent which way the current or particles travel, as with reversed direction their state is reversed. The change is easily made, either in air or oil of turpentine, between two opposed rods, for an insulated ball being placed in connexion with either rod and brought near its

extremity, will cause the current to set towards it from the opposite end.

1602. The two currents often occur at once, as when both terminations present brushes, and frequently when they exhibit the glow (1531.). In such cases, the charged particles, or many of them, meet and mutually discharge each other (1548. 1612.). If a smoking wax taper be held at the end of an insulating rod towards a charged prime conductor, it will very often happen that two currents will form, and be rendered visible by its vapour, one passing as a fine filament of smoky particles directly to the charged conductor, and the other passing as directly from the same taper wick outwards, and from the conductor; the principles of inductive action and charge, which were referred to in considering the relation of a carrier ball and a conductor (1566.), being here also called into play.

1603. The general analogy and, I think I may say, identity of action found to exist as to insulation and conduction (1338. 1561.) when bodies, the best and the worst in the classes of insulators or conductors, were compared, led me to believe that the phenomena of *convection* in badly conducting media were not without their parallel amongst the best conductors, such even as the metals. Upon consideration, the cones produced by Davy* in fluid metals, as mercury and tin, seemed to be cases in point, and probably also the elongation of the metallic medium through which a current of electricity was passing, described by Ampère (1113.) †; for it is not difficult to conceive, that the diminution of convective effect, consequent upon the high conducting power of the metallic media used in these experiments, might be fully compensated for by the enormous quantity of electricity passing. In fact it is impossible not to expect *some* effect, whether sensible or not, of the kind in question, when such a current is passing through a fluid offering a sensible resistance to the passage of the electricity, and, thereby giving proof of a certain degree of insulating power (1328.).

1604. I endeavoured to connect the convective currents in air, oil of turpentine, &c. and those in metals, by intermediate cases, but found this not easy to do. On taking bodies, for in-

* Philosophical Transactions, 1823, p. 155.

† Bibliothèque Universelle, xxi. 47.

stances, which, like water, acids, solutions, fused salts or chlorides, &c., have intermediate conducting powers, the minute quantity of electricity which the common machine can supply (371. 861.) is exhausted instantly, so that the cause of the phenomenon is kept either very low in intensity, or the instant of time during which the effect lasts is so small, that one cannot hope to observe the result sought for. If a voltaic battery be used, these bodies are all electrolytes, and the evolution of gas, or the production of other changes, interferes and prevents observation of the effect required.

1605. There are, nevertheless, some experiments which illustrate the connection. Two platina wires, forming the electrodes of a powerful voltaic battery, were placed side by side, near each other, in distilled water, hermetically sealed up in a strong glass tube, some minute vegetable fibres being present in the water. When, from the evolution of gas and the consequent increased pressure, the bubbles formed on the electrodes were so small as to produce but feebly ascending currents, then it could be observed that the filaments present were attracted and repelled between the two wires, as they would have been between two oppositely charged surfaces in air or oil of turpentine, moving so quickly as to displace and disturb the bubbles and the currents which these tended to form. Now I think it cannot be doubted, that under similar circumstances, and with an abundant supply of electricity, of sufficient tension also, convective currents might have been formed; the attractions and repulsions of the filaments were, in fact, the elements of such currents (1572.), and therefore water, though almost infinitely above air or oil of turpentine as a conductor, is a medium in which similar currents can take place.

1606. I had an apparatus made (fig. 142.) in which *a* is a plate of shell-lac, *b* a fine platina wire passing through it, and having only the section of the wire exposed above; *c* a ring of bibulous paper resting on the shell-lac, and *d* distilled water retained by the paper in its place, and just sufficient in quantity to cover the end of the wire *b*; another wire, *e*, touched a piece of tinfoil lying in the water, and was also connected with a discharging train; in this way it was easy, by rendering *b* either positive or negative, to send a current of electricity by its extremity into the fluid, and so away by the wire *e*.

1607. On connecting *b* with the conductor of a powerful electrical machine, not the least disturbance of the level of the fluid over the end of the wire during the working of the machine could be observed; but at the same time there was not the smallest indication of electrical charge about the conductor or of the machine, so complete was the discharge. I conclude that the quantity of electricity passed in a *given time* had been too small, when compared with the conducting power of the fluid to produce the desired effect.

1608. I then charged a large Leyden battery (291.), and discharged it through the wire *b*, interposing, however, a wet thread, two feet long, to prevent a spark in the water, and to reduce what would else have been a sudden violent discharge into one of more moderate character, enduring for a sensible length of time (334.). I now did obtain a very brief elevation of the water over the end of the wire; and though a few minute bubbles of gas were at the same time formed there, so as to prevent me from asserting that the effect was unequivocally the same as that obtained by DAVY in the metals, yet, according to my best judgement, it was partly, and I believe principally, of that nature.

1609. I employed a voltaic battery of 100 pair of four-inch plates for experiments of a similar nature with electrolytes. In these cases the shell-lac was cupped, and the wire *b* 0.2 of an inch in diameter. Sometimes I used a positive amalgamated zinc wire in contact with dilute sulphuric acid; at others, a negative copper wire in a solution of sulphate of copper; but, because of the evolution of gas, the precipitation of copper, &c., I was not able to obtain decided results. It is but right to mention, that when I made use of mercury, endeavouring to repeat DAVY'S experiment, the battery of 100 pair was not sufficient to produce the elevations*.

1610. The latter experiments (1609.) may therefore be considered as failing to give the hoped-for proof, but I have much confidence in the former (1605. 1608.), and in the considerations (1603.) connected with them. If I have rightly viewed

* In the experiments at the Royal Institution, Sir H. Davy used, I think, 500 or 600 pairs of plates. Those at the London Institution were made with the apparatus of Mr. Pepys (consisting of an enormous single pair of plates) described in the Philosophical Transactions for 1823, p. 187.

them, and we may be allowed to compare the currents at points and surfaces in such extremely different bodies as air and the metals, and admit that they are effects of the *same* kind, differing only in degree and in proportion to the insulating or conducting power of the dielectric used, what great additional argument we obtain in favour of that theory, which in the phenomena of insulation and conduction also, as in these, would link *the same* apparently dissimilar substances together (1336. 1561.); and how completely the general view, which refers all the phenomena to the direct action of the molecules of matter, seems to embrace the various isolated phenomena as they successively come under consideration!

1611. The connection of this convective or carrying effect, which depends upon a certain degree of insulation, with conduction; *i. e.* the occurrence of both in so many of the substances referred to, as, for instance, the metals, water, air, &c., would lead to many very curious theoretical generalizations, which I must not indulge in here. One point, however, I shall venture to refer to. Conduction appears to be essentially an action of contiguous particles, and the considerations just stated, together with others formerly expressed (1326. 1336, &c.), lead to the conclusion, that all bodies conduct, and by the same process, air as well as metals; the only difference being in the necessary degree of force or tension between the particles which must exist before the act of conduction or transfer from one particle to another can take place.

1612. The question then arises, what is this limiting condition which separates, as it were, conduction and insulation from each other? Does it consist in a difference between the two contiguous particles, or the contiguous poles of these particles, in the nature and amount of positive and negative force, no communication or discharge occurring unless that difference rises up to a certain degree, variable for different bodies, but always the same for the same body? Or is it true that, however small the difference between two such particles, if *time* be allowed, equalization of force will take place, even with the particles of such bodies as air, sulphur, or lac? In the first case, insulating power in any particular body would be proportionate

to the degree of the assumed necessary difference of force ; in the second, to the *time* required to equalize equal degrees of difference in different bodies. With regard to airs, one is almost led to expect a permanent difference of force ; but in all other bodies, time seems to be quite sufficient to ensure, ultimately, complete conduction. The difference in the modes by which insulation may be sustained, or conduction effected, is not a mere fanciful point, but one of great importance, as being essentially connected with the molecular theory of induction, and the manner in which the particles of bodies assume and retain their polarized state.

¶ xi. *Relation of a vacuum to electrical phenomena.*

1613. It would seem strange, if a theory which refers all the phenomena of insulation and conduction. *i. e.* all electrical phenomena, to the action of contiguous particles, were to omit to notice the assumed possible case of a *vacuum*. Admitting that a vacuum can be produced, it would be a very curious matter indeed to know what its relation to electrical phenomena would be ; and as shell-lac and metal are directly opposed to each other, whether a vacuum would be opposed to them both, and allow neither of induction or conduction across it. Mr. Morgan* has said that a vacuum does not conduct. Sir H. Davy concluded from his investigations, that as perfect a vacuum as could be made † did conduct, but does not consider the prepared spaces which he used as absolute vacua. In such experiments I think I have observed the luminous discharge to be principally on the inner surface of the glass ; and it does not appear at all unlikely, that, if the vacuum refused to conduct, still the surface of glass next it might carry on that action.

1614. At one time, when I thought inductive force was exerted in right lines, I hoped to illustrate this important question by making experiments on induction with metallic mirrors (used only as conducting vessels) exposed towards a very clear sky at night time, and of such concavity that nothing but the firmament could be visible from the lowest part of the concave

* Philosophical Transactions, 1785, p. 272.

† Ibid. 1822, p. 64.

n, fig. 143. Such mirrors, when electrified, as by connexion with a Leyden jar, and examined by a carrier ball, readily gave electricity at the lowest part of their concavity if in a room ; but I was in hopes of finding that, circumstanced as before stated, they would give little or none at the same spot, if the atmosphere above really terminated in a vacuum. I was disappointed in the conclusion, for I obtained as much electricity there as before ; but on discovering the action of induction in curved lines (1231.), found a full and satisfactory explanation of the result.

1615. My theory, as far as I have ventured it, does not pretend to decide upon the consequences of a vacuum. It is not at present limited sufficiently, or rendered precise enough, either by experiments relating to spaces void of matter, or those of other kinds, to indicate what would happen in the vacuum case. I have only as yet endeavoured to establish, what all the facts seem to prove, that when electrical phenomena, as those of induction, conduction, insulation, and discharge occur, they depend on, and are produced by the action of *contiguous* particles of matter, the next existing particle being considered as the contiguous one ; and I have further assumed, that these particles are polarized ; that each exhibits the two forces, or the force in two directions (1295. 1298.) ; and that they act at a distance, only by acting on the *contiguous* and intermediate particles.

1616. But assuming that a perfect vacuum were to intervene in the course of the lines of inductive action (1304), it does not follow from this theory, that the particles on opposite sides of such a vacuum could not act on each other. Suppose it possible for a positively electrified particle to be in the centre of a vacuum an inch in diameter, nothing in my present views forbids that the particle should act at the distance of half an inch on all the particles forming the inner superficies of the bounding sphere, and with a force consistent with the well known law of the squares of the distance. But suppose the sphere of an inch were full of insulating matter, the electrified particle would not then, according to my notion, act directly on the distant particles, but on those in immediate association with it, employing *all* its power in polarizing them ; producing in them negative force equal in amount to its own positive force and directed to-

wards the latter, and positive force of equal amount directed outwards and acting in the same manner upon the layer of particles next in succession. So that ultimately, those particles in the surface of a sphere of half an inch radius, which were acted on *directly* when that sphere was a vacuum, will now be acted on *indirectly* as respects the central particle or source of action, *i. e.* they will be polarized in the same way, and with the same amount of force.

§ 19. *Nature of the electric current.*

1617. The word *current* is so expressive in common language, that when applied in the consideration of electrical phenomena we can hardly divest it sufficiently of its meaning, or prevent our minds from being prejudiced by it (283. 511.). I shall use it in its common electrical sense, namely, to express generally a certain condition and relation of electrical forces supposed to be in progression.

1618. A current is produced both by excitement and discharge; and whatsoever the variation of the two general causes may be, the effect remains the same. Thus excitement may occur in many ways, as by friction, chemical action, influence of heat, change of condition, induction, &c.; and discharge has the forms of conduction, electrolyzation, disruptive discharge, and convection; yet the current connected with these actions, when it occurs, appears in all cases to be the same. This constancy in the character of the current, notwithstanding the particular and great variations which may be made in the mode of its occurrence, is exceedingly striking and important; and its investigation and development promise to supply the most open and advantageous road to a true and intimate understanding of the nature of electrical forces.

1619. As yet the phenomena of the current have presented nothing in opposition to the view I have taken of the nature of induction as an action of contiguous particles. I have endeavoured to divest myself of prejudices and to look for contradictions, but I have not perceived any in conductive, electrolytic, convective, or disruptive discharge.

1620. Looking at the current as a *cause*, it exerts very extraordinary and diverse powers, not only in its course and on the bodies in which it exists, but collaterally, as in inductive or magnetic phenomena.

1621. *Electrolytic action*.—One of its direct actions is the exertion of pure chemical force, this being a result which has now been examined to a considerable extent. The effect is found to be *constant* and *definite* for the quantity of electric force discharged (783, &c.); and beyond that, the *intensity* required is in relation to the intensity of the affinity or forces to be overcome (904. 906. 911.). The current and its consequences are here proportionate; the one may be employed to represent the other; no part of the effect of either is lost or gained; so that the case is a strict one, and yet it is the very case which most strikingly illustrates the doctrine that induction is an action of contiguous particles (1164. 1343.).

1622. The process of electrolytic discharge appears to me to be in close analogy, and perhaps in its nature identical with another process of discharge, which at first seems very different from it, I mean *convection* (1347. 1572.). In the latter case the particles may travel for yards across a chamber; they may produce strong winds in the air, so as to move machinery; and in fluids, as oil of turpentine, may even shake the hand, and carry heavy metallic bodies about*; and yet I do not see that the force, either in kind or action, is at all different to that by which a particle of hydrogen leaves one particle of oxygen to go to another, or by which a particle of oxygen travels in the contrary direction.

1623. Travelling particles of the air can effect chemical changes just as well as the contact of a fixed platina electrode, or that of a combining electrode, or the ions of a decomposing electrolyte (453. 471.); and in the experiment formerly described, where eight places of decomposition were rendered active by one current (469.), and where charged particles of air in motion were the only electrical means of connecting these

* If a metallic vessel three or four inches deep, containing oil of turpentine, be insulated and electrified, and a rod with a ball (an inch or more in diameter) at the end have the ball immersed in the fluid whilst the end is held in the hand, the mechanical force generated when the ball is moved to and from the sides of the vessel will soon be evident to the experimenter.

parts of the current, it seems to me that the action of the particles of the electrolyte and of the air were essentially the same. A particle of air was rendered positive; it travelled in a certain determinate direction, and coming to an electrolyte, communicated its powers; an equal amount of positive force was accordingly acquired by another particle (the hydrogen), and the latter, so charged, travelled as the former did, and in the same direction, until it came to another particle, and transferred its power and motion, making that other particle active. Now, though the particle of air travelled over a visible and occasionally a large space, whilst the particle of the electrolyte moved over an exceedingly small one; though the air particle might be oxygen, nitrogen, or hydrogen, receiving its charge from force of high intensity, whilst the electrolytic particle of hydrogen had a natural aptness to receive the positive condition with extreme facility; though the air particle might be charged with very little electricity at a very high intensity by one process, whilst the hydrogen particle might be charged with much electricity at a very low intensity by another process; these are not differences of kind, as relates to the final discharging action of these particles, but only of degree; not essential differences which make things unlike, but such differences as give to things, similar in their nature, that great variety which fits them for their office in the system of the universe.

1624. So when a particle of air, or of dust in it, electrified at a negative point, moves on through the influence of the inductive forces (1572.) to the next positive surface, and after discharge passes away, it seems to me to represent exactly that particle of oxygen which, having been rendered negative in the electrolyte, is urged by the same disposition of inductive forces, and going to the positive platina electrode, is there discharged, and then passes away, as the air or dust did before it.

1625. *Heat* is another direct effect of the *current* upon substances in which it occurs, and it becomes a very important question, as to the relation of the electric and heating forces, whether the latter is always definite in amount*. There are many cases, even amongst bodies which conduct without change, that at present are irreconcilable with the assumption that it

* See De la Rive's Researches, Bib. Universelle, 1829. xl. p. 40.

is* ; but there are also many which indicate that, when proper limitations are applied, the heat produced is definite. Harris has shown this for a given length of current in a metallic wire, using common electricity† ; and De la Rive has proved the same point for voltaic electricity by his beautiful application of Breguet's thermometer‡.

1626. When the production of heat is observed in electrolytes under decomposition, the results are still more complicated. But important steps have been taken in the investigation of this branch of the subject by De la Rive § and others ; and it is more than probable that, when the right limitations are applied, constant and definite results will here also be obtained.

1627. It is a most important part of the character of the current, and essentially connected with its very nature, that it is always the same. The two forces are everywhere in it. There is never one current of force or one fluid only. Any one part of the current may, as respects the presence of the two forces there, be considered as precisely the same with any other part ; and the numerous experiments which imply their possible separation, as well as the theoretical expressions which, being used daily, assume it, are, I think in contradiction with facts (511. &c.). It appears to me to be as impossible to assume a current of positive or a current of negative force alone, or of the two at once with any predominance of one over the other, as it is to give an absolute charge to matter (516. 1169. 1177.).

1628. The establishment of this truth, if, as I think, it be a truth, or on the other hand the disproof of it, is of the greatest consequence. If, as a first principle, we can establish, that the centres of the two forces, or elements of force, never can be separated to any sensible distance, or at all events not further than the space between two contiguous particles (1615.), or if we can establish the contrary conclusion, how much more clear

* Amongst others, Davy, *Philosophical Transactions*, 1821, p. 438. Pelletier's important results, *Annales de Chimie*, 1834, lvi. p. 371, and Becquerel's non-heating current, *Bib. Universelle*, 1835, lx. 218.

† *Philosophical Transactions*, 1824, pp. 225. 228.

‡ *Annales de Chimie*, 1836, lxii. 177.

§ *Bib. Universelle*, 1829, xl. 49 ; and Ritchie, *Phil. Trans.* 1832, p. 296.

is our view of what lies before us, and how much less embarrassed the ground over which we have to pass in attaining to it, than if we remain halting between two opinions! And if, with that feeling, we rigidly test every experiment which bears upon the point, as far as our prejudices will let us (1161.), instead of permitting them with a theoretic expression to pass too easily away, are we not much more likely to attain the real truth, and from that proceed with safety to what is at present unknown?

1629. I say these things, not, I hope, to advance a particular view, but to draw the strict attention of those who are able to investigate and judge of the matter, to what must be a turning point in the theory of electricity; to a separation of two roads, one only of which can be right; and I hope I may be allowed to go a little further into the facts which have driven me to the view I have just given.

1630. When a wire in the voltaic circuit is heated, the temperature frequently rises first, or most at one end. If this effect were due to any relation of positive or negative as respects the current, it would be exceedingly important. I therefore examined several such cases; but when, keeping the contacts of the wire and its position to neighbouring things unchanged, I altered the direction of the current, I found that the effect remained unaltered, showing that it depended, not upon the direction of the current, but on other circumstances. So there is here no evidence of a difference between one part of the circuit and another.

1631. The same point, *i. e.* uniformity in every part, may be illustrated by what may be considered as the inexhaustible nature of the current when producing particular effects; for these effects depend upon transfer only, and do not consume the power. Thus a current which will heat one inch of platina wire will heat a hundred inches (853. note). If a current be sustained in a constant state, it will decompose the fluid in one voltameter only, or in twenty others if they be placed in the circuit, in each to an amount equal to that in the single one.

1632. Again, in cases of disruptive discharge, as in the spark, there is frequently a dark part (1422.) which, by Professor Johnson, has been called the neutral point*; and this has given

* Silliman's Journal, 1834, xxv. p. 57.

rise to the use of expressions implying that there are two electricities existing separately, which, passing to that spot, there combine and neutralize each other*. But if such expressions are understood as correctly indicating that positive electricity alone is moving between the positive ball and that spot, and negative electricity only between the negative ball and that spot, then what strange conditions these parts must be in; conditions, which to my mind are every way unlike those which really occur! In such a case, one part of a current would consist of positive electricity only, and that moving in one direction; another part would consist of negative electricity only, and that moving in the other direction; and a third part would consist of an accumulation of the two electricities, not moving in either direction, but mixing up together, and being in a relation to each other utterly unlike any relation which could be supposed to exist in the two former portions of the discharge. This does not seem to me to be natural. In a current, whatever form the discharge may take, or whatever part of the circuit or current is referred to, as much positive force as is there exerted in one direction, so much negative force is there exerted in the other. If it were not so we should have bodies electrified not merely positive and negative, but on occasions in a most extraordinary manner, one being charged with five, ten, or twenty times as much of both positive and negative electricity in equal quantities as another. At present, however, there is no known fact indicating such states.

1633. Even in cases of convection, or carrying discharge, the statement that the current is everywhere the same must in effect be true (1627.); for how, otherwise could the results formerly described occur? When currents of air constituted the mode of discharge between the portions of paper moistened with iodide of potassium or sulphate of soda (465. 469.), decomposition occurred; and I have since ascertained that, whether a current of positive air issued from a spot, or one of negative air passed towards it, the effect of the evolution of iodine or of acid was the same, whilst the reversed currents produced alkali. So also in the magnetic experiments (307.) whether the discharge was effected by the introduction of a wire, or the occurrence of a spark, or the passage of convective currents either one way

* Thomson on Heat and Electricity, p. 471.

or the other, (depending on the electrified state of the particles) the result was the same, being in all cases dependent upon the perfect current.

1634. Hence, the section of a current compared with other sections of the same current must be a constant quantity, if the actions exerted be of the same kind; or if of different kinds, then the forms under which the effects are produced are equivalent to each other, and experimentally convertible at pleasure. It is in sections, therefore, we must look for identity of electrical force, even to the sections of sparks and carrying actions, as well as those of wires and electrolytes.

1635. In illustration of the utility and importance of establishing that which may be the true principle, I will refer to a few cases. The doctrine of unipolarity, as formerly stated, and I think generally understood*, is evidently inconsistent with my view of a current (1627.); and the later singular phenomena of poles and flames described by Erman and others † partake of the same inconsistency of character. If a unipolar body could exist, *i. e.* one that could conduct the one electricity and not the other, what very new characters we should have a right to expect in the currents of single electricities passing through them, and how greatly ought they to differ, not only from the common current which is supposed to have both electricities travelling in opposite directions in equal amount at the same time, but also from each other! The facts, which are excellent, have, however, gradually been more correctly explained by Becquerel ‡, Andrews §, and others; and I understand that Professor Ohms || has perfected the work, in his close examination of all

* Erman, *Annales de Chimie*, 1807, lxi. p. 115. Davy's *Elements*, p. 168. Biot, *Ency. Brit. Supp.* iv. p. 444. Becquerel, *Traité*, i. p. 167. De la Rive, *Bib. Univ.* 1837. vii. 392.

† Erman, *Annales de Chimie*, 1824, xxv. 278. Becquerel, *Ibid.* xxxvi. p. 329.

‡ Becquerel, *Annales de Chimie*, 1831, xlvi. p. 283.

§ Andrews, *Philosophical Magazine*, 1836, ix. 182.

|| Schweigger's *Jahrbuch der Chemie*, &c. 1830. Heft 8. Not understanding German, it is with extreme regret I confess I have not access, and cannot do justice, to the many most valuable papers in experimental electricity published in that language. I take this opportunity also of stating another circumstance which occasions me great trouble, and, as I find by experience, may make me seemingly regardless of the labours of others:—it is a gradual loss of memory for some years past; and now, often when I read a memoir, I re-

the phenomena; and after showing that similar phenomena can take place with good conductors, proves that with soap, &c. many of the effects are the mere consequences of the bodies evolved by electrolytic action.

1636. I conclude, therefore, that the *facts* upon which the doctrine of unipolarity was founded are not adverse to that unity and indivisibility of character which I have stated the current to possess, any more than the phenomena of the pile itself, (which might well bear comparison with those of unipolar bodies,) are opposed to it. Probably the effects which have been called effects of unipolarity, and the peculiar differences of the positive and negative surface when discharging into air, gases, or other dielectrics (1480. 1525.) which have been already referred to, may have considerable relation to each other*.

1637. M. de la Rive has recently described a peculiar and remarkable effect of heat on a current when passing between electrodes and a fluid †. It is, that if platina electrodes dip into acidulated water, no change is produced in the passing current by making the positive electrode hotter or colder; whereas making the negative electrode hotter increased the deflexion of a galvanometer affected by the current, from 12° to 30° and even 45°, whilst making it colder diminished the current in the same high proportions.

1638. That one electrode should have this striking relation to heat whilst the other remained absolutely without, seem to me as incompatible with what I conceived to be the character of a current as unipolarity (1627. 1635.), and it was therefore with some anxiety that I repeated the experiment. The electrodes which I used were platina; the electrolyte, water containing about one sixth of sulphuric acid by weight: the voltaic battery consisted of two pairs of amalgamated zinc and platina plates in dilute sulphuric acid, and the galvanometer in the circuit was one with two needles, and gave when the arrangement was complete a deflexion of 10° or 12°.

member that I have seen it before, and would have rejoiced if at the right time I could have recollected and referred to it in the progress of my own papers.—M. F.

* See also Hare in Silliman's Journal, 1833, xxiv. 246.

† Bibliothèque Universelle, 1837, vii. 388.

1639. Under these circumstances heating either electrode increased the current; heating both produced still more effect. When both were heated, if either were cooled, the effect on the current fell in proportion. The proportion of effect due to heating this or that electrode varied, but on the whole heating the negative seemed to favour the passage of the current somewhat more than heating the positive. Whether the application of heat were by a flame applied underneath, or one directed by a blowpipe from above, or by a hot iron or coal, the effect was the same.

1640. Having thus removed the difficulty out of the way of my views regarding a current, I did not pursue this curious experiment further. It is probable, that the difference between my results and those of M. de la Rive may depend upon the relative values of the currents used; for I employed only a weak one resulting from two pairs of plates two inches long and half an inch wide, whilst M. de la Rive used four pairs of plates of sixteen square inches in surface.

1641. Electric discharges in the atmosphere in the form of balls of fire have occasionally been described. Such phenomena appear to me to be incompatible with all that we know of electricity and its modes of discharge. As *time* is an element in the effect (1418. 1436.) it is possible perhaps that an electric discharge might really pass as a ball from place to place; but as every thing shows that its velocity must be almost infinite, and the time of its duration exceedingly small, it is impossible that the eye should perceive it as anything else than a line of light. That phenomena of balls of fire may appear in the atmosphere, I do not mean to deny; but that they have anything to do with the discharge of ordinary electricity, or are at all related to lightning or atmospheric electricity, is much more than doubtful.

1642. All these considerations, and many others, help to confirm the conclusion, drawn over and over again, that the current is an indivisible thing; an axis of power, in every part of which both electric forces are present in equal amount* (517.

* I am glad to refer here to the results obtained by Mr. Christie with mag-

1627.). With conduction and electrolyzation, and even discharge by spark, such a view will harmonize without hurting any of our preconceived notions; but as relates to convection, a more startling result appears, which must therefore be considered.

1643. If two balls A and B be electrified in opposite states and held within each other's influence, the moment they move towards each other, a current, or those effects which are understood by the word current, will be produced. Whether A move towards B, or B move in the opposite direction towards A, a current, and in both cases having the same *direction*, will result. If A and B move from each other, then a *current* in the opposite direction, or equivalent effects, will be produced.

1644. Or, as charge exists only by induction (1178. 1299.), and a body when electrified is necessarily in relation to other bodies in the opposite state; so, if a ball be electrified positively in the middle of a room and be then moved in any direction, effects will be produced, as if a *current* in the same direction (to use the conventional mode of expression) had existed: or, if the ball be negatively electrified, and then moved, effects as if a current in a direction contrary to that of the motion had been formed, will be produced.

1645. I am saying of a single particle or of two what I have before said, in effect, of many (1633.). If the former account of currents be true, then that just stated must be a necessary result. And, though the statement may seem startling at first, it is to be considered that, according to my theory of induction, the charged conductor or particle is related to the distant conductor in the opposite state, or that which terminates the extent of the induction, by all the intermediate particles (1165. 1295.), these becoming polarized exactly as the particles of a solid electrolyte do when interposed between the two electrodes. Hence the conclusion regarding the unity and identity of the current in the case of convection, jointly with the former cases, is not so strange as it might at first appear.

1646. There is a very remarkable phenomenon or effect of the electrolytic discharge, first pointed out, I believe, by Mr. neto-electricity, *Philosophical Transactions*, 1833, p. 113. note. As regards the current in a wire, they confirm everything that I am contending for.

Porrett, of the accumulation of fluid under decomposing action in the current on one side of an interposed diaphragm*. It is a mechanical result; and as the liquid passes from the positive towards the negative electrode in all the known cases, it seems to establish a relation to the polar condition of the dielectric in which the current exists (1164. 1525.). It has not as yet been sufficiently investigated by experiment; for De la Rive says †, it requires that the water should be a bad conductor, as, for instance, distilled water, the effect not happening with strong solutions; whereas, Dutrochet says ‡ the contrary is the case, and that, the effect is not directly due to the electric current.

1647. Becquerel, in his *Traité de l'Electricité*, has brought together the considerations which arise for and against the opinion, that the effect generally is an electric effect §. Though I have no decisive fact to quote at present, I cannot refrain from venturing an opinion, that the effect is analogous both to combination and convection (1623.), being a case of carrying due to the relation of the diaphragm and the fluid in contact with it, through which the electric discharge is jointly effected; and further, that the peculiar relation of positive and negative small and large surfaces already referred to (1482. 1503, 1525.), may be the direct cause of the fluid and the diaphragm travelling in contrary but determinate directions. A very valuable experiment has been made by M. Becquerel with particles of clay ||, which will probably bear importantly on this point.

1648. *As long as* the terms *current* and *electro-dynamic* are used to express those relations of the electric forces in which progression of either fluids or effects are supposed to occur (283.), *so long* will the idea of velocity be associated with them; and this will, perhaps, be more especially the case if the hypothesis of a fluid or fluids be adopted.

1649. Hence has arisen the desire of estimating this velocity either directly or by some effect dependent on it; and amongst

* *Annals of Philosophy*, 1816, viii. p. 75.

† *Annales de Chimie*, 1835, xxviii. p. 196.

‡ *Annales de Chimie*, 1832, xlix. p. 423.

§ Vol. iv. pp. 192, 197.

|| *Traité de l'Electricité*, i. p. 285.

the endeavours to do this correctly, may be mentioned especially those of Dr. Watson* in 1748, and of Professor Wheatstone† in 1834; the electricity in the early trials being supposed to travel from end to end of the arrangement, but in the later investigations a distinction occasionally appearing to be made between the transmission of the effect and of the supposed fluid by the motion of whose particles that effect is produced.

1650. Electrolytic action has a remarkable bearing upon this question of the velocity of the current, especially as connected with the theory of an electric fluid or fluids. In it there is an evident transfer of power with the transfer of each particle of the anion or cation present, to the next particles of the cation or anion; and as the amount of power is definite, we have in this way a means of localizing as it were the force, identifying it by the particle and dealing it out in successive portions, which leads, I think, to very striking results.

1651. Suppose, for instance, that water is undergoing decomposition by the powers of a voltaic battery. Each particle of hydrogen as it moves one way, or of oxygen as it moves in the other direction, will transfer a certain amount of electrical force associated with it in the form of chemical affinity (822. 852. 918.) onwards through a distance, which is equal to that through which the particle itself has moved. This transfer will be accompanied by a corresponding movement in the electrical forces throughout every part of the circuit formed (1627. 1634.), and its effects may be estimated, as, for instance, by the heating of a wire (853.) at any particular section of the current however distant. If the water be a cube of an inch in the side, the electrodes touching, each by a surface of one square inch, and being an inch apart, then, by the time that a tenth of it, or 25·25 grains, is decomposed, the particles of oxygen and hydrogen throughout the mass may be considered as having moved relatively to each other in opposite directions, to the amount of the tenth of an inch; *i. e.* that two particles at first in combination will after the motion be the tenth of an inch apart. Other motions which occur in the fluid will not at all interfere with this result; for they have no power of accelerating or retarding the electric discharge, and possess in fact no relation to it.

* Philosophical Transactions, 1748.

† Ibid. 1834, p. 583.

1652. The quantity of electricity in 25·25 grains of water is, according to an estimate of the force which I formerly made (861.), equal to above 24 millions of charges of a large Leyden battery; or it would have kept any length of a platina wire $\frac{1}{164}$ of an inch in diameter red hot for an hour and a half (853.). This result, though given only as an approximation, I have seen no reason as yet to alter, and it is confirmed generally by the experiments and results of M. Pouillet*. According to Mr. Wheatstone's experiments, the influence or effects of the current would appear at a distance of 576,000 miles in a second †. We have, therefore, in this view of the matter, on the one hand, an enormous quantity of power equal to a most destructive thunder storm appearing instantly at the distance of 576,000 miles from its source, and on the other, a quiet effect, in producing which the power had taken an hour and a half to travel through the tenth of an inch: yet these are the equivalents to each other, being effects observed at the sections of one and the same current (1634.).

1653. It is time that I should call attention to the lateral or transverse forces of the *current*. The great things which have been achieved by Oersted, Arago, Ampère, Davy, De la Rive, and others, and the high degree of simplification which has been introduced into their arrangement by the theory of Ampère, have not only done their full service in advancing most rapidly this branch of knowledge, but have secured to it such attention that there is no necessity for urging on its pursuit. I refer of course to magnetic action and its relations; but though this is the only recognised lateral action of the current, there is great reason for believing that others exist and would by their discovery reward a close search for them (951.).

1654. The magnetic or transverse action of the current seems to be in a most extraordinary degree independent of those variations or modes of action which it presents directly in its course; it consequently is of the more value to us, as it gives us a higher relation of the power than any that might have varied with each mode of discharge. This discharge,

* Becquerel, *Traité de l'Electricité*, v. p. 278.

† *Philosophical Transactions*, 1834, p. 589.

whether it be by conduction through a wire with infinite velocity (1652.), or by electrolyzation with its corresponding and exceeding slow motion (1651.), or by spark, and probably even by convection, produces a transverse magnetic action always the same in kind and direction.

1655. It has been shown by several experimenters, that whilst the discharge is of the *same kind* the amount of lateral or magnetic force is very constant (216. 366. 367. 368. 376.). But when we wish to compare discharge of different kinds, for the important purpose of ascertaining whether the same amount of current will in its *different forms* produce the same amount of transverse action, we find the data very imperfect. Davy noticed, that when the electric current was passing through an aqueous solution it affected a magnetic needle*, and Dr. Ritchie says, that the current in the electrolyte is as magnetic as that in a metallic wire†, and has caused water to revolve round a magnet as a wire carrying the current would revolve.

1656. Disruptive discharge produces its magnetic effects : a strong spark, passed transversely to a steel needle, will magnetise it as well as if the electricity of the spark were conducted by a metallic wire occupying the line of discharge ; and Sir H. Davy has shown that the discharge of a voltaic battery in vacuo is affected and has motion given to it by approximated magnets ‡.

1657. Thus the three very different modes of discharge, namely, conduction, electrolyzation, and disruptive discharge, agree in producing the important transverse phenomenon of magnetism. Whether convection or carrying discharge will produce the same phenomenon has not been determined, and the few experiments I have as yet had time to make do not enable me to answer in the affirmative.

1658. Having arrived at this point in the consideration of the current and in the endeavour to apply its phenomena as tests of the truth or fallacy of the theory of induction which I have ventured to set forth, I am now very much tempted to indulge in a few speculations respecting its lateral action and its possi-

* Philosophical Transactions, 1821, p. 426.

† Ibid. 1832, p. 294.

‡ Philosophical Transactions, 1821, p. 427.

ble connexion with the transverse condition of the lines of ordinary induction (1165. 1304.)*. I have long sought and still seek for an effect or condition which shall be to statical electricity what magnetic force is to current electricity (1411.) ; for as the lines of discharge are associated with a certain transverse effect, so it appeared to me impossible but that the lines of tension or of inductive action, which of necessity precede that discharge, should also have their correspondent transverse condition or effect (951.).

1659. According to the beautiful theory of Ampère, the transverse force of a current may be represented by its attraction for a similar current and its repulsion of a contrary current. May not then the equivalent transverse force of static electricity be represented by that lateral tension or repulsion which the lines of inductive action appear to possess (1304.) ? Then again, when current or discharge occurs between two bodies, previously under inductrical relations to each other, the lines of inductive force will weaken and fade away, and, as their lateral repulsive tension diminishes, will contract and ultimately disappear in the line of discharge. May not this be an effect identical with the attractions of similar currents ? *i. e.* may not the passage of static electricity into current electricity, and that of the lateral tension of the lines of inductive force into the lateral attraction of lines of similar discharge, have the same relation and dependences, and run parallel to each other ?

1660. The phenomena of induction amongst currents which I had the good fortune to discover some years ago (6. &c. 1048.) may perchance here form a connecting link in the series of effects. When a current is first formed, it tends to produce a current in the contrary direction in all the matter around it ; and if that matter have conducting properties and be fitly circumstanced, such a current is produced. On the contrary, when the original current is stopped, one in the same direction tends to form all around it, and, in conducting matter properly arranged, will be excited.

1661. Now though we perceive the effects only in that portion of matter which, being in the neighbourhood, has conducting properties, yet hypothetically it is probable, that the non-conducting matter has also its relations to, and is affected by,

* Refer for further investigations to 1709.—1736.—*Dec.* 1838.

the disturbing cause, though we have not yet discovered them. Again and again the relation of conductors and non-conductors has been shown to be one not of opposition in kind, but only of degree (1334. 1603.) ; and therefore, for this, as well as for other reasons, it is probable, that what will affect a conductor will affect an insulator also ; producing perhaps what may deserve the term of the electrotonic state (60. 242. 1114.).

1662. It is the feeling of the necessity of some lateral connexion between the lines of electric force (1114.) ; of some link in the chain of effects as yet unrecognised, that urges me to the expression of these speculations. The same feeling has led me to make many experiments on the introduction of insulating dielectrics having different inductive capacities (1270. 1277.) between magnetic poles and wires carrying currents, so as to pass across the lines of magnetic force. I have employed such bodies both at rest and in motion, without, as yet, being able to detect any influence produced by them ; but I do by no means consider the experiments as sufficiently delicate, and intend, very shortly, to render them more decisive*.

1663. I think the hypothetical question may at present be put thus : can such considerations as those already generally expressed (1658.) account for the transverse effects of electrical currents ? are two such currents in relation to each other merely by the inductive condition of the particles of matter between them, or are they in relation by some higher quality and condition (1654.), which, acting at a distance and not by the intermediate particles, has, like the force of gravity, no relation to them ?

1664. If the latter be the case, then, when electricity is acting upon and in matter, its direct and its transverse action are essentially different in their nature ; for the former, if I am correct, will depend upon the contiguous particles, and the latter will not. As I have said before, this may be so, and I incline to that view at present ; but I am desirous of suggesting considerations why it may not, that the question may be thoroughly sifted.

1665. The transverse power has a character of polarity impressed upon it. In the simplest forms it appears as attraction

* See onwards 1711.—1726.—Dec. 1838.

or repulsion, according as the currents are in the same or different directions : in the current and the magnet it takes up the condition of tangential forces ; and in magnets and their particles produces poles. Since the experiments have been made which have persuaded me that the polar forces of electricity, as in induction and electrolytic action (1298. 1343.), show effects at a distance only by means of the polarized contiguous and intervening particles, I have been led to expect that *all polar forces* act in the same general manner ; and the other kinds of phenomena which one can bring to bear upon the subject seem fitted to strengthen that expectation. Thus in crystallizations the effect is transmitted from particle to particle ; and in this manner, in acetic acid or freezing water a crystal a few inches or even a couple of feet in length will form in less than a second, but progressively and by a transmission of power from particle to particle. And, as far as I remember, no case of polar action, or partaking of polar action, except the one under discussion, can be found which does not act by contiguous particles*. It is apparently of the nature of polar forces that such should be the case, for the one force either finds or develops the contrary force near to it, and has, therefore, no occasion to seek for it at a distance.

1666. But leaving these hypothetical notions respecting the nature of the lateral action out of sight, and returning to the direct effects, I think that the phenomena examined and reasoning employed in this and the two preceding papers tend to confirm the view first taken (1164.), namely, that ordinary inductive action and the effects dependent upon it are due to an action of the contiguous particles of the dielectric interposed between the charged surfaces or parts which constitute, as it were, the terminations of the effect. The great point of distinction and power (if it have any) in the theory is, the making the dielectric of essential and specific importance, instead of leaving it as it were a mere accidental circumstance or the simple representative of space, having no more influence over the phenomena than the space occupied by it. I have still certain other results and views respecting the nature of the electrical forces and exei-

* I mean by contiguous particles those which are next to each other, not that there is *no* space between them. See (1616.).

tation, which are connected with the present theory ; and, unless upon further consideration they sink in my estimation, I shall very shortly put them into form as another series of these electrical researches.

Royal Institution,
February 14th, 1838.

FOURTEENTH SERIES.

§ 20. *Nature of the electric force or forces.* § 21. *Relation of the electric and magnetic forces.* § 22. *Note on electrical excitation.*

Received June 21, 1838.—Read June 21, 1838.

§ 20. *Nature of the electric force or forces.*

1667. THE theory of induction set forth and illustrated in the three preceding series of experimental researches does not assume anything new as to the nature of the electric force or forces, but only as to their distribution. The effects may depend upon the association of one electric fluid with the particles of matter, as in the theory of Franklin, Epinus, Cavendish, and Mossotti; or they may depend upon the association of two electric fluids, as in the theory of Dufay and Poisson; or they may not depend upon anything which can properly be called the electric fluid, but on vibrations or other affections of the matter in which they appear. The theory is unaffected by such differences in the mode of viewing the nature of the forces; and though it professes to perform the important office of stating *how* the powers are arranged (at least in inductive phenomena), it does not, as far as I can yet perceive, supply a single experiment which can be considered as a distinguishing test of the truth of any one of these various views.

1668. But, to ascertain how the forces are arranged, to trace them in their various relations to the particles of matter, to determine their general laws, and also the specific differences which occur under these laws, is as important as, if not more so than, to know whether the forces reside in a fluid or not; and with the hope of assisting in this research, I shall offer some further developments, theoretical and experimental, of the conditions under which I suppose the particles of matter are placed when exhibiting inductive phenomena.

1669. The theory assumes that all the *particles*, whether of insulating or conducting matter, are as wholes conductors.

1670. That not being polar in their normal state, they can become so by the influence of neighbouring charged particles, the polar state being developed at the instant, exactly as in an insulated conducting *mass* consisting of many particles.

1671. That the particles when polarized are in a forced state, and tend to return to their normal or natural condition.

1672. That being as wholes conductors, they can readily be charged, either *bodily* or *polarly*.

1673. That particles which being contiguous* are also in the line of inductive action can communicate or transfer their polar forces one to another *more or less* readily.

1674. That those doing so less readily require the polar forces to be raised to a higher degree before this transference or communication takes place.

1675. That the *ready* communication of forces between contiguous particles constitutes *conduction*, and the *difficult* communication *insulation*; conductors and insulators being bodies whose particles naturally possess the property of communicating their respective forces easily or with difficulty; having these differences just as they have differences of any other natural property.

1676. That ordinary induction is the effect resulting from the action of matter charged with excited or free electricity upon insulating matter, tending to produce in it an equal amount of the contrary state.

1677. That it can do this only by polarizing the particles contiguous to it, which perform the same office to the next, and these again to those beyond; and that thus the action is propagated from the excited body to the next conducting mass, and there renders the contrary force evident in consequence of the effect of communication which supervenes in the conducting mass upon the polarization of the particles of that body (1675.).

1678. That therefore induction can only take place through or across insulators; that induction is insulation, it being the necessary consequence of the state of the particles and the mode in which the influence of electrical forces is transferred or transmitted through or across such insulating media.

* See note to 1164.—*Dec.* 1838.

1679. The particles of an insulating dielectric whilst under induction may be compared to a series of small magnetic needles, or more correctly still to a series of small insulated conductors. If the space round a charged globe were filled with a mixture of an insulating dielectric, as oil of turpentine or air, and small globular conductors, as shot, the latter being at a little distance from each other so as to be insulated, then these would in their condition and action exactly resemble what I consider to be the condition and action of the particles of the insulating dielectric itself (1337.). If the globe were charged, these little conductors would all be polar; if the globe were discharged, they would all return to their normal state, to be polarized again upon the recharging of the globe. The state developed by induction through such particles on a mass of conducting matter at a distance would be of the contrary kind, and exactly equal in amount to the force in the inductive globe. There would be a lateral diffusion of force (1224. 1297.), because each polarized sphere would be in an active or tense relation to all those contiguous to it, just as one magnet can affect two or more magnetic needles near it, and these again a still greater number beyond them. Hence would result the production of curved lines of inductive force if the inductive body in such a mixed dielectric were an uninsulated metallic ball (1219. &c.) or other properly shaped mass. Such curved lines are the consequences of the two electric forces arranged as I have assumed them to be: and, that the inductive force can be directed in such curved lines is the strongest proof of the presence of the two powers and the polar condition of the dielectric particles.

1680. I think it is evident, that in the case stated, action at a distance can only result through an action of the contiguous conducting particles. There is no reason why the inductive body should polarize or affect *distant* conductors and leave those *near* it, namely the particles of the dielectric, unaffected: and everything in the form of fact and experiment with conducting masses or particles of a sensible size contradicts such a supposition.

1681. A striking character of the electric power is that it is limited and exclusive, and that the two forces being always present are exactly equal in amount. The forces are related in one of two ways, either as in the natural normal condition of an

uncharged insulated conductor; or as in the charged state, the latter being a case of induction.

1682. Cases of induction are easily arranged so that the two forces being limited in their direction shall present no phenomena or indications external to the apparatus employed. Thus, if a Leyden jar, having its external coating a little higher than the internal, be charged and then its charging ball and rod removed, such jar will present no electrical appearances so long as its outside is uninsulated. The two forces which may be said to be in the coatings, or in the particles of the dielectric contiguous to them, are entirely engaged to each other by induction through the glass; and a carrier ball (1181.) applied either to the inside or outside of the jar will show no signs of electricity. But if the jar be insulated, and the charging ball and rod, in an uncharged state and suspended by an insulating thread of white silk, be restored to their place, then the part projecting above the jar will give electrical indications and charge the carrier, and at the same time the *outside* coating of the jar will be found in the opposite state and inductive towards external surrounding objects.

1683. These are simple consequences of the theory. Whilst the charge of the inner coating could induce only through the glass towards the outer coating, and the latter contained no more of the contrary force than was equivalent to it, no induction external to the jar could be perceived; but when the inner coating was extended by the rod and ball so that it could induce through the air towards external objects, then the tension of the polarized glass molecules would, by their tendency to return to the normal state, fall a little, and a portion of the charge passing to the surface of this new part of the inner conductor, would produce inductive action through the air towards distant objects, whilst at the same time a part of the force in the outer coating previously directed inwards would now be at liberty, and indeed be constrained to induce outwards through the air, producing in that outer coating what is sometimes called, though I think very improperly, free charge. If a small Leyden jar be converted into that form of apparatus usually known by the name of the electric well, it will illustrate this action very completely.

1684. The terms *free charge* and *dissimulated electricity* convey therefore erroneous notions if they are meant to imply

any difference as to the mode or kind of action. The charge upon an insulated conductor in the middle of a room is in the same relation to the walls of that room as the charge upon the inner coating of a Leyden jar is to the outer coating of the same jar. The one is not more *free* or more *dissimulated* than the other; and when sometimes we make electricity appear where it was not evident before, as upon the outside of a charged jar, when, after insulating it, we touch the inner coating, it is only because we divert more or less of the inductive force from one direction into another; for not the slightest change is in such circumstances impressed upon the character or action of the force.

1685. Having given this general theoretical view, I will now notice particular points relating to the nature of the assumed electric polarity of the insulating dielectric particles.

1686. The polar state may be considered in common induction as a forced state, the particles tending to return to their normal condition. It may probably be raised to a very high degree by approximation of the inductive and inducteous bodies or by other circumstances; and the phenomena of electrolyzation (861. 1652. 1706.) seem to imply that the quantity of power which can thus be accumulated on a single particle is enormous. Hereafter we may be able to compare corpuscular forces, as those of gravity, cohesion, electricity, and chemical affinity, and in some way or other from their effects deduce their relative equivalents; at present we are not able to do so, but there seems no reason to doubt that their electrical, which are at the same time their chemical forces (891. 918.), will be by far the most energetic.

1687. I do not consider the powers when developed by the polarization as limited to two distinct points or spots on the surface of each particle to be considered as the poles of an axis, but as resident on large portions of that surface, as they are upon the surface of a conductor of sensible size when it is thrown into a polar state. But it is very probable, notwithstanding, that the particles of different bodies may present specific differences in this respect, the powers not being equally diffused though equal in quantity; other circumstances also, as form and quality, giving to each a peculiar polar relation. It is perhaps to the existence of some such differences as these that

we may attribute the specific actions of the different dielectrics in relation to discharge (1394. 1508.). Thus with respect to oxygen and nitrogen singular contrasts were presented when spark and brush discharge were made to take place in these gases, as may be seen by reference to the Table in paragraph 1518 of the Thirteenth Series; for with nitrogen, when the small negative or the large positive ball was rendered inductive, the effects corresponded with those which in oxygen were produced when the small positive or the large negative ball was rendered inductive.

1688. In such solid bodies as glass, lac, sulphur, &c., the particles appear to be able to become polarized in all directions, for a mass when experimented upon so as to ascertain its inductive capacity in three or more directions (1690.), gives no indication of a difference. Now as the particles are fixed in the mass, and as the direction of the induction through them must change with its change relative to the mass, the constant effect indicates that they can be polarized electrically in any direction. This accords with the view already taken of each particle as a whole being a conductor (1669.), and, as an experimental fact, helps to confirm that view.

1689. But though particles may thus be polarized in *any* direction under the influence of powers which are probably of extreme energy (1686.), it does not follow that each particle may not tend to polarize to a greater degree, or with more facility, in one direction than another; or that different kinds may not have specific differences in this respect, as they have differences of conducting and other powers (1296. 1326. 1395.). I sought with great anxiety for a relation of this nature; and selecting crystalline bodies as those in which all the particles are symmetrically placed, and therefore best fitted to indicate any result which might depend upon variation of the direction of the forces to the direction of the particles in which they were developed, experimented very carefully with them. I was the more strongly stimulated to this inquiry by the beautiful electrical condition of the crystalline bodies tourmaline and boracite, and hoped also to discover a relation between electric polarity and that of crystallization, or even of cohesion itself (1316.). My experiments have not established any connexion of the kind sought for. But as I think it of equal importance to show either that there is or is not such a relation, I shall briefly describe the results.

1690. The form of experiment was as follows. A brass ball 0.73 of an inch in diameter, fixed at the end of a horizontal brass rod, and that at the end of a brass cylinder, was by means of the latter connected with a large Leyden battery (291.) by perfect metallic communications, the object being to keep that ball, by its connexion with the charged battery in an electrified state, very nearly uniform, for half an hour at a time. This was the inductive ball. The inductive ball was the carrier of the torsion electrometer (1229. 1314.) ; and the dielectric between them was a cube cut from a crystal, so that two of its faces should be perpendicular to the optical axis, whilst the other four were parallel to it. A small projecting piece of shell-lac was fixed on the inductive ball at that part opposite to the attachment of the brass rod, for the purpose of preventing actual contact between the ball and the crystal cube. A coat of shell-lac was also attached to that side of the carrier ball which was to be towards the cube, being also that side

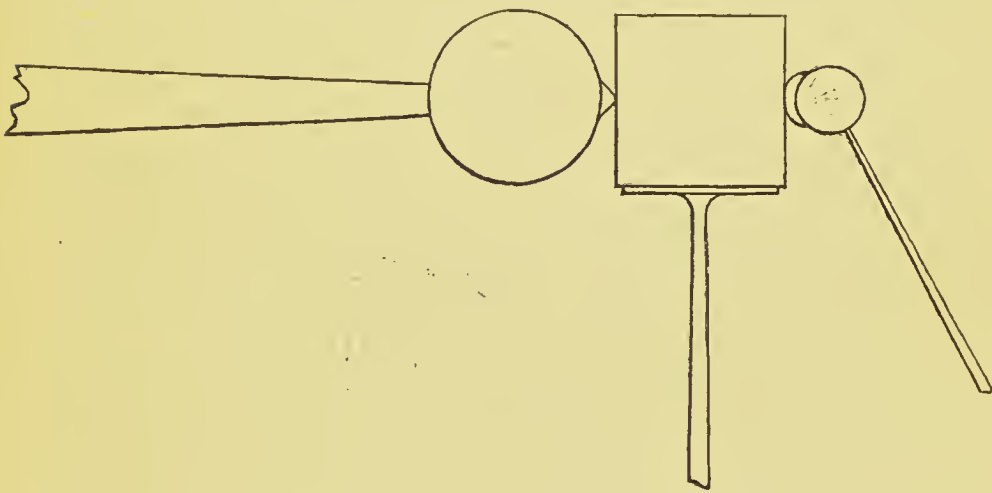

which was furthest from the repelled ball in the electrometer when placed in its position in that instrument. The cube was covered with a thin coat of shell-lac dissolved in alcohol, to prevent the deposition of damp upon its surface from the air. It was supported upon a small table of shell-lac fixed on the top of a stem of the same substance, the latter being of sufficient strength to sustain the cube, and yet flexible enough from its length to act as a spring, and allow the cube to bear, when in its place, against the shell-lac on the inductive ball.

1691. Thus it was easy to bring the inductive ball always to the same distance from the inductive ball, and to uninsulate and insulate it again in its place; and then, after measuring the force in the electrometer (1181.), to return it to its place opposite to the inductive ball for a second observation. Or it was easy by revolving the stand which supported the cube to bring four of its faces in succession towards the inductive ball, and so observe the force when the lines of inductive action (1304.) coincided with, or were transverse to, the direction of the optical axis of the crystal. Generally from twenty to twenty-eight observations were made in succession upon the four vertical faces of a cube, and then an average expression of the inductive force was obtained, and compared with similar averages obtained at other times, every precaution being taken to secure accurate results.

1692. The first cube used was of *rock crystal*; it was 0·7 of an inch in the side. It presented a remarkable and constant difference, the average of not less than 197 observations, giving 100 for the specific inductive capacity in the direction coinciding with the optical axis of the cube, whilst 93·59 and 93·31 were the expressions for the two transverse directions.

1693. But with a second cube of rock crystal corresponding results were not obtained. It was 0·77 of an inch in the side. The average of many experiments gave 100 for the specific inductive capacity coinciding with the direction of the optical axis, and 98·6 and 99·92 for the two other directions.

1694. Lord Ashley, whom I have found ever ready to advance the cause of science, obtained for me the loan of three globes of rock crystal belonging to Her Grace the Duchess of Sutherland for the purposes of this investigation. Two had such fissures as to render them unfit for the experiments (1193. 1698.). The third, which was very superior, gave me no indications of any difference in the inductive force for different directions.

1695. I then used cubes of Iceland spar. One 0·5 of an inch in diameter gave 100 for the axial direction, and 98·66 and 95·74 for the two cross directions. The other, 0·8 of an inch in the side, gave 100 for the axial direction, whilst 101·73 and 101·86 were the numbers for the cross direction.

1696. Besides these differences there were others, which I do not think it needful to state, since the main point is not con-

firmed. For though the experiments with the first cube raised great expectation, they have not been generalized by those which followed. I have no doubt of the results as to that cube, but they cannot as yet be referred to crystallization. There are in the cube some faintly coloured layers parallel to the optical axis, and the matter which colours them may have an influence; but then the layers are also nearly parallel to a cross direction, and if at all influential should show some effect in that direction also, which they did not.

1697. In some of the experiments one half or one part of a cube showed a superiority to another part, and this I could not trace to any charge the different parts had received. It was found that the varnishing of the cubes prevented any communication of charge to them, except (in a few experiments) a small degree of the negative state, or that which was contrary to the state of the inductive ball (1564. 1566.).

1698. I think it right to say that, as far as I could perceive, the insulating character of the cubes used was perfect, or at least so nearly perfect, as to bear a comparison with shell-lac, glass, &c. (1255.). As to the cause of the differences, other than regular crystalline structure, there may be several. Thus minute fissures in the crystal insensible to the eye may be so disposed as to produce a sensible electrical difference (1193.). Or the crystallization may be irregular; or the substance may not be quite pure; and if we consider how minute a quantity of matter will alter greatly the conducting power of water, it will seem not unlikely that a little extraneous matter diffused through the whole or part of a cube, may produce effects sufficient to account for all the irregularities of action that have been observed.

1699. An important inquiry regarding the electrical polarity of the particles of an insulating dielectric, is, whether it be the molecules of the particular substance acted on, or the component or ultimate particles, which thus act the part of insulated conducting polarizing portions (1669.).

1700. The conclusion I have arrived at is, that it is the molecules of the substance which polarize as wholes (1347.); and that however complicated the composition of a body may be, all those particles or atoms which are held together by chemical affinity to form one molecule of the resulting body,

act as one conducting mass or particle when inductive phenomena and polarization are produced in the substance of which it is a part.

1701. This conclusion is founded on several considerations. Thus if we observe the insulating and conducting power of elements when they are used as dielectrics, we find some, as sulphur, phosphorus, chlorine, iodine, &c., whose particles insulate, and therefore polarize in a high degree; whereas others, as the metals, give scarcely any indication of possessing a sensible proportion of this power (1328.), their particles freely conducting one to another. Yet when these enter into combination they form substances having no direct relation apparently, in this respect, to their elements; for water, sulphuric acid, and such compounds formed of insulating elements, conduct by comparison freely; whilst oxide of lead, flint glass, borate of lead, and other metallic compounds containing very high proportions of conducting matter, insulate excellently well. Taking oxide of lead therefore as the illustration, I conceive that it is not the particles of oxygen and lead which polarize separately under the act of induction, but the molecules of oxide of lead which exhibit this effect, all the elements of one particle of the resulting body, being held together as parts of one conducting individual by the bonds of chemical affinity; which is but another term for electrical force (918.).

1702. In bodies which are electrolytes we have still further reason for believing in such a state of things. Thus when water, chloride of tin, iodide of lead, &c. in the solid state are between the electrodes of the voltaic battery, their particles polarize as those of any other insulating dielectric do (1164.); but when the liquid state is conferred on these substances, the polarized particles divide, the two halves, each in a highly charged state, travelling onwards until they meet other particles in an opposite and equally charged state, with which they combine, to the neutralization of their chemical, *i. e.* their electrical forces, and the reproduction of compound particles, which can again polarize as wholes, and again divide to repeat the same series of actions (1347.).

1703. But though electrolytic particles polarize as wholes, it would appear very evident that in them it is not a matter of entire indifference *how* the particle polarizes (1689.), since, when free to move (380, &c.) the polarities are ultimately dis-

tributed in reference to the elements ; and sums of force equivalent to the polarities, and very definite in kind and amount, separate, as it were, from each other, and travel onwards with the elementary particles. And though I do not pretend to know what an atom is, or how it is associated or endowed with electrical force, or how this force is arranged in the cases of combination and decomposition, yet the strong belief I have in the electrical polarity of particles when under inductive action, and the bearing of such an opinion on the general effects of induction, whether ordinary or electrolytic, will be my excuse, I trust, for a few hypothetical considerations.

1704. In electrolyzation it appears that the polarized particles would (because of the gradual change which has been induced upon the chemical, *i. e.* the electrical forces of their elements (918.)) rather divide than discharge to each other without division (1348.); for if their division, *i. e.* their decomposition and recombination, be prevented by giving them the solid state, then they will insulate electricity perhaps a hundredfold more intense than that necessary for their electrolyzation (419, &c.). Hence the tension necessary for direct conduction in such bodies appears to be much higher than that for decomposition (419. 1164. 1344.).

1705. The remarkable stoppage of electrolytic conduction by solidification (380. 1358.), is quite consistent with these views of the dependence of that process on the polarity which is common to all insulating matter when under induction, though attended by such peculiar electro-chemical results in the case of electrolytes. Thus it may be expected that the first effect of induction is so to polarize and arrange the particles of water that the positive or hydrogen pole of each shall be from the positive electrode and towards the negative electrode, whilst the negative or oxygen pole of each shall be in the contrary direction ; and thus when the oxygen and hydrogen of a particle of water have separated, passing to and combining with other hydrogen and oxygen particles, unless these new particles of water could turn round they could not take up that position necessary for their successful electrolytic polarization. Now solidification, by fixing the water particles and preventing them from assuming that essential preliminary position, prevents also their electrolysis (413.) ; and so the transfer of forces in that manner being prevented (1347. 1703.), the substance acts as an

ordinary insulating dielectric (for it is evident by former experiments (419. 1704.) that the insulating tension is higher than the electrolytic tension), induction through it rises to a higher degree, and the polar condition of the molecules as wholes, though greatly exalted, is still securely maintained.

1706. When decomposition happens in a fluid electrolyte, I do not suppose that all the molecules in the same sectional plane (1634.) part with and transfer their electrified particles or elements at once. Probably the *discharge force* for that plane is summed up on one or a few particles, which decomposing, travelling and recombining, restore the balance of forces, much as in the case of spark disruptive discharge (1406.); for as those molecules resulting from particles which have just transferred power must by their position (1705.) be less favourably circumstanced than others, so there must be some which are most favourably disposed, and these, by giving way first, will for the time lower the tension and produce discharge.

1707. In former investigations of the action of electricity (821, &c.) it was shown, from many satisfactory cases, that the quantity of electric power transferred onwards was in proportion to and was definite for a given quantity of matter moving as anion or cation onwards in the electrolytic line of action; and there was strong reason to believe that each of the particles of matter then dealt with, had associated with it a definite amount of electrical force, constituting its force of chemical affinity, the chemical equivalents and the electro-chemical equivalents being the same (836.). It was also found with few, and I may now perhaps say with no exceptions (1341.), that only those compounds containing elements in single proportions could exhibit the characters and phenomena of electrolytes (697.); oxides, chlorides, and other bodies containing more than one proportion of the electro negative element refusing to decompose under the influence of the electric current.

1708. Probable reasons for these conditions and limitations arise out of the molecular theory of induction. Thus when a liquid dielectric, as chloride of tin, consists of molecules, each composed of a single particle of each of the elements, then as these can convey equivalent opposite forces by their separation in opposite directions, both decomposition and transfer can result. But when the molecules, as in the bichloride of tin, consist of one particle or atom of one element, and two of the other,

then the simplicity with which the particles may be supposed to be arranged and to act, is destroyed. And, though it may be conceived that when the molecules of bichloride of tin are polarized as wholes by the induction across them, the positive polar force might accumulate on the one particle of tin whilst the negative polar force accumulated on the two particles of chlorine associated with it, and that these might respectively travel right and left to unite with other two of chlorine and one of tin, in analogy with what happens in cases of compounds consisting of single proportions, yet this is not altogether so evident or probable. For when a particle of tin combines with two of chlorine, it is difficult to conceive that there should not be some relation of the three in the resulting molecule analogous to fixed position, the one particle of metal being perhaps symmetrically placed in relation to the two of chlorine: and, it is not difficult to conceive of such particles that they could not assume that position dependent both on their polarity and the relation of their elements, which appears to be the first step in the process of electrolyzation (1345. 1705.).

§. 21. *Relation of the electric and magnetic forces.*

1709. I have already ventured a few speculations respecting the probable relation of magnetism, as the transverse force of the current, to the divergent or transverse force of the lines of inductive action belonging to static electricity (1658, &c.).

1710. In the further consideration of this subject it appeared to me to be of the utmost importance to ascertain, if possible, whether this lateral action which we call magnetism, or sometimes the induction of electrical currents (26. 1048, &c.), is extended to a distance *by the action of the intermediate particles* in analogy with the induction of static electricity, or the various effects, such as conduction, discharge, &c., which are dependent on that induction; or, whether its influence at a distance is altogether independent of such intermediate particles (1662.).

1711. I arranged two magneto-electric helices with iron cores end to end, but with an interval of an inch and three quarters between them, in which interval was placed the end or pole of a bar magnet. It is evident, that on moving the magnetic pole from one core towards the other, a current would tend to form

in both helices, in the one because of the lowering, and in the other because of the strengthening of the magnetism induced in the respective soft iron cores. The helices were connected together, and also with a galvanometer, so that these two currents should coincide in direction, and tend by their joint force to deflect the needle of the instrument. The whole arrangement was so effective and delicate, that moving the magnetic pole about the eighth of an inch to and fro two or three times, in periods equal to those required for the vibrations of the galvanometer needle, was sufficient to cause considerable vibration in the latter; thus showing readily the consequence of strengthening the influence of the magnet on the one core and helix, and diminishing it on the other.

1712. Then without disturbing the distances of the magnet and cores, plates of substances were interposed. Thus calling the two cores A and B, a plate of shell-lac was introduced between the magnetic pole and A for the time occupied by the needle in swinging one way; then it was withdrawn for the time occupied in the return swing; introduced again for another equal portion of time; withdrawn for another portion, and so on eight or nine times; but not the least effect was observed on the needle. In other cases the plate was alternated, *i. e.* it was introduced between the magnet and A for one period of time, withdrawn and introduced between the magnet and B for the second period, withdrawn and restored to its first place for the third period, and so on, but with no effect on the needle.

1713. In these experiments *shell-lac* in plates 0·9 of an inch in thickness, *sulphur* in a plate 0·9 of an inch in thickness, and *copper* in a plate 0·7 of an inch in thickness were used without any effect. And I conclude that bodies, contrasted by the extremes of conducting and insulating power, and opposed to each other as strongly as metals, air, and sulphur, show no difference with respect to magnetic forces when placed in their lines of action, at least under the circumstances described.

1714. With a plate of iron, or even a small piece of that metal, as the head of a nail, a very different effect was produced, for then the galvanometer immediately showed its sensibility, and the perfection of the general arrangement.

1715. I arranged matters so that a plate of *copper* 0·2 of an inch in thickness, and ten inches in diameter, should have the part near the edge interposed between the magnet and the core,

in which situation it was first rotated rapidly, and then held quiescent alternately, for periods according with that required for the swinging of the needle; but not the least effect upon the galvanometer was produced.

1716. A plate of shell-lac 0.6 of an inch in thickness was applied in the same manner, but whether rotating or not it produced no effect.

1717. Occasionally the plane of rotation was directly across the magnetic curve: at other times it was made as oblique as possible; the direction of the rotation being also changed in different experiments, but not the least effect was produced.

1718. I now removed the helices with their soft iron cores, and replaced them by two *flat helices* wound upon card-board, each containing forty-two feet of silked copper wire, and having no associated iron. Otherwise the arrangement was as before, and exceedingly sensible; for a very slight motion of the magnet between the helices produced an abundant vibration of the galvanometer needle.

1719. The introduction of plates of shell-lac, sulphur, or copper into the intervals between the magnet and these helices (1713.), produced not the least effect, whether the former were quiescent or in rapid revolution (1715.). So here no evidence of the influence of the intermediate particles could be obtained (1710.).

1720. The magnet was then removed and replaced by a flat helix, corresponding to the two former, the three being parallel to each other. The middle helix was so arranged that a voltaic current could be sent through it at pleasure. The former galvanometer was removed, and one with a double coil employed, one of the lateral helices being connected with one coil, and the other helix with the other coil, in such manner that when a voltaic current was sent through the middle helix its inductive action (26.) on the lateral helices should cause currents in them, having contrary directions in the coils of the galvanometer. By a little adjustment of the distances these induced currents were rendered exactly equal, and the galvanometer needle remained stationary notwithstanding their frequent production in the instrument. I will call the middle coil C, and the external coils A and B.

1721. A plate of copper 0.7 of an inch thick and six inches square, was placed between coils C and B, their respective di-

stances remaining unchanged; and then a voltaic current from twenty pairs of 4-inch plates was sent through the coil C, and intermitted, in periods fitted to produce an effect on the galvanometer (1712.), if any difference had been produced in the effect of C on A and B. But notwithstanding the presence of air in one interval and copper in the other, the inductive effect was exactly alike on the two coils, and as if air had occupied both intervals. So that notwithstanding the facility with which any induced currents might form in the thick copper plate, the coil outside of it was just as much affected by the central helix C as if no such conductor as the copper had been there (65.).

1722. Then, for the copper plate was substituted one of sulphur 0.9 of an inch thick; still the results were exactly the same, *i. e.* there was no action at the galvanometer.

1723. Thus it appears that when a voltaic current in one wire is exerting its inductive action to produce a contrary or a similar current in a neighbouring wire, according as the primary current is commencing or ceasing, it makes not the least difference whether the intervening space is occupied by such insulating bodies as air, sulphur, and shell-lac, or such conducting bodies as copper, and the other non-magnetic metals.

1724. A correspondent effect was obtained with the like forces when resident in a magnet thus. A single flat helix (1718.) was connected with a galvanometer, and a magnetic pole placed near to it; then by moving the magnet to and from the helix, or the helix to and from the magnet, currents were produced indicated by the galvanometer.

1725. The thick copper plate (1721.) was afterwards interposed between the magnetic pole and the helix; nevertheless on moving these two and fro, effects, exactly the same in direction and amount, were obtained as if the copper had not been there. So also on introducing a plate of sulphur into the interval, not the least influence on the currents produced by motion of the magnet or coils could be obtained.

1726. These results, with many others which I have not thought it needful to describe, would lead to the conclusion that (judging by the *amount* of effect produced at a distance by forces transverse to the electric current, *i. e.* magnetic forces), the intervening matter, and therefore the intervening particles, have nothing to do with the phenomena; or in other words, that though the inductive force of static electricity

is transmitted to a distance by the action of the intermediate particles (1164. 1666.), the transverse inductive force of currents, which can also act at a distance, is not transmitted by the intermediate particles in a similar way.

1727. It is however very evident that such a conclusion cannot be considered as proved. Thus when the metal copper is between the pole and the helix (1715. 1719. 1725.) or between the two helices (1721.) we know that its particles are affected, and can by proper arrangements make their peculiar state for the time very evident by the production of either electrical or magnetical effects. It seems impossible to consider this effect on the particles of the intervening matter as independent of that produced by the inductive coil or magnet C, on the inductive coil or core A (1715. 1721.); for since the inductive body is equally affected by the inductive body whether these intervening and affected particles of copper are present or not (1723. 1725.), such a supposition would imply that the particles so affected had no reaction back on the original inductive forces. The more reasonable conclusion, as it appears to me, is, to consider these affected particles as efficient in continuing the action onwards from the inductive to the inductive body, and by this very communication producing the effect of *no loss* of induced power at the latter.

1728. But then it may be asked what is the relation of the particles of insulating bodies, such as air, sulphur, or lac, when *they* intervene in the line of magnetic action? The answer to this is at present merely conjectural. I have long thought there must be a particular condition of such bodies corresponding to the state which causes currents in metals and other conductors (26. 53. 191. 201. 213.); and considering that the bodies are insulators one would expect that state to be one of tension. I have by rotating non-conducting bodies near magnetic poles and poles near them, and also by causing powerful electric currents to be suddenly formed and to cease around and about insulators in various directions, endeavoured to make some such state sensible, but have not succeeded. Nevertheless, as any such state must be of exceedingly low intensity, because of the feeble intensity of the currents which are used to induce it, it may well be that the state may exist, and may be discoverable by some more expert experimentalist, though I have not been able to make it sensible.

1729. It appears to me possible, therefore, and even probable, that magnetic action may be communicated to a distance by the action of the intervening particles, in a manner having a relation to the way in which the inductive forces of static electricity are transferred to a distance (1677.); the intervening particles assuming for the time more or less of a peculiar condition, which (though with a very imperfect idea) I have several times expressed by the term *electro-tonic state* (60. 242. 1114. 1661.). I hope it will not be understood that I hold the settled opinion that such is the case. I would rather in fact have proved the contrary, namely, that magnetic forces are quite independent of the matter intervening between the inductive and the inductive bodies; but I cannot get over the difficulty presented by such substances as copper, silver, lead, gold, carbon, and even aqueous solutions (201. 213.), which though they are known to assume a peculiar state whilst intervening between the bodies acting and acted upon (1727.), no more interfere with the final result than those which have as yet had no peculiarity of condition discovered in them.

1730. A remark important to the whole of this investigation ought to be made here. Although I think the galvanometer used as I have described it (1711. 1720.) is quite sufficient to prove that the final amount of action on each of the two coils or the two cores A and B (1713. 1719.) is equal, yet there is an effect which *may* be consequent on the difference of action of two interposed bodies which it would not show. As time enters as an element into these actions* (125.), it is very possible that the induced actions on the helices or cores A, B, though they rise to the same degree when air and copper, or air and lac are contrasted as intervening substances, do not do so in the same time; and yet, because of the length of time occupied by a vibration of the needle, this difference may not be visible, both effects rising to their maximum in periods so short as to make no sensible portion of that required for a vibration of the needle, and so exert no visible influence upon it.

1731. If the lateral or transverse force of electrical currents, or what appears to be the same thing, magnetic power, could be proved to be influential at a distance independently of the

* See *Annales de Chemie*, 1833, tom. li. pp. 422, 428.

intervening contiguous particles, then, as it appears to me, a real distinction, of a high and important kind, would be established between the natures of these two forces (1654. 1664.). I do not mean that the powers are independent of each other and might be rendered separatively active, on the contrary they are probably essentially associated (1654.), but it by no means follows that they are of the same nature. In common statical induction, in conduction, and in electrolyzation, the forces at the opposite extremities of the particles which coincide with the lines of action, and have commonly been distinguished by the term electric, are polar, and in the cases of contiguous particles act only to insensible distances; whilst those which are transverse to the direction of these lines, and are called magnetic, are circumferential, act at a distance, and if not through the mediation of the intervening particles, have their relations to ordinary matter entirely unlike those of the electrical forces with which they are associated.

1732. To decide this question of the identity or distinction of the two kinds of power, and establish their true relation, would be exceedingly important. The question seems fully within the reach of experiment, and offers a high reward to him who will attempt its settlement.

1733. I have already expressed a hope of finding an effect or condition which shall be to statical electricity what magnetic force is to current electricity (1658.). If I could have proved to my own satisfaction that magnetic forces extended their influence to a distance by the conjoined action of the intervening particles in a manner analogous to that of electrical forces, then I should have thought that the lateral tension of the lines of inductive action (1659.), or that state so often hinted at as the electro-tonic state (1661. 1662.), was this related condition of statical electricity.

1734. It may be said that the state of *no lateral action* is to static or inductive force the equivalent of *magnetism* to current force; but that can only be upon the view that electric and magnetic action are in their nature essentially different (1664.). If they are the same power, the whole difference in the results being the consequence of the difference of *direction*, then the normal or *undeveloped* state of electric force will correspond with the state of *no lateral action* of the magnetic state of the force; the electric current will correspond with the lateral ef-

fects commonly called magnetism: but the state of static induction which is between the normal condition and the current will still require a corresponding lateral condition in the magnetic series, presenting its own peculiar phenomena; for it can hardly be supposed that the normal electric, and the inductive or polarized electric condition, can both have the same lateral relation. If magnetism be a separate and a higher relation of the powers developed, then perhaps the argument which presses for this third condition of that force would not be so strong.

1735. I cannot conclude these general remarks upon the relation of the electric and magnetic forces without expressing my surprise at the results obtained with the copper plate (1721. 1725.). The experiments with the flat helices represent one of the simplest cases of the induction of electrical currents (1720.); the effect, as is well known, consisting in the production of a momentary current in a wire at the instant when a current in the contrary direction begins to pass through a neighbouring parallel wire, and the production of an equally brief current in the reverse direction when the determining current is stopped (26.). Such being the case, it seems very extraordinary that this induced current which takes place in the helix A when there is only air between A and C (1720.) should be equally strong when that air is replaced by an enormous mass of that excellently conducting metal copper (1721.). It might have been supposed that this mass would have allowed of the formation and discharge of almost any quantity of currents in it, which the helix C was competent to induce, and so in some degree have diminished if not altogether prevented the effect in A: instead of which, though we can hardly doubt that an infinity of currents are formed at the moment in the copper plate, still not the smallest diminution or alteration of the effect in A appears (65.). Almost the only way of reconciling this effect with generally received notions is, as it appears to me, to admit that magnetic action is communicated by the action of the intervening particles (1729. 1733.).

1736. This condition of things, which is very remarkable, accords perfectly with the effects observed in solid helices where wires are coiled over wires to the amount of five or six or more layers in succession, no diminution of effect on the outer ones being occasioned by those within.

§ 22. *Note on electrical excitation.*

1737. That the different modes in which electrical excitement takes place will some day or other be reduced under one common law can hardly be doubted, though for the present we are bound to admit distinctions. It will be a great point gained when these distinctions are, not removed, but understood.

1738. The strict relation of the electrical and chemical powers renders the chemical mode of excitement the most instructive of all, and the case of two isolated combining particles is probably the simplest that we possess. Here however the action is local, and we still want such a test of electricity as shall apply to it, to cases of current electricity, and also to those of static induction. Whenever by virtue of the previously combined condition of some of the acting particles (923.) we are enabled, as in the voltaic pile, to expand or convert the local action into a current, then chemical action can be traced through its variations to the production of *all* the phenomena of tension and the static state, these being in every respect the same as if the electric forces producing them had been developed by friction.

1739. It was Berzelius, I believe, who first spoke of the aptness of certain particles to assume opposite states when in presence of each other (959.). Hypothetically we may suppose these states to increase in intensity by increased approximation, or by heat, &c. until at a certain point combination occurs, accompanied by such an arrangement of the forces of the two particles between themselves as is equivalent to a discharge, producing at the same time a particle which is throughout a conductor (1700.).

1740. This aptness to assume an excited electrical state (which is probably polar in those forming non-conducting matter) appears to be a primary fact, and to partake of the nature of induction (1162.), for the particles do not seem capable of retaining their particular state independently of each other (1177.) or of matter in the opposite state. What appears to be definite about the particles of matter is their assumption of a *particular* state, as the positive or negative, in relation to each other, and not of either one or other indifferently; and also the acquirement of force up to a certain amount.

1741. It is easily conceivable that the same force which causes

local action between two free particles shall produce current force if one of the particles is previously in combination, forming part of an electrolyte (923. 1738.). Thus a particle of zinc, and one of oxygen, when in presence of each other, exert their inductive forces (1740.), and these at last rise up to the point of combination. If the oxygen be previously in union with hydrogen, it is held so combined by an analogous exertion and arrangement of the forces; and as the forces of the oxygen and hydrogen are for the time of combination mutually engaged and related, so when the superior relation of the forces between the oxygen and zinc come into play, the induction of the former or oxygen towards the metal cannot be brought on and increased without a corresponding deficiency in its induction towards the hydrogen with which it is in combination (for the amount of force in a particle is considered as definite), and the latter therefore has its force turned towards the oxygen of the next particle of water; thus the effect may be considered as extended to sensible distances, and thrown into the condition of static induction, which being discharged and then removed by the action of other particles produces currents.

1742. In the common voltaic battery, the current is occasioned by the tendency of the zinc to take the oxygen of the water from the hydrogen, the effective action being at the place where the oxygen leaves the previously existing electrolyte. But Schönbein has arranged a battery in which the effective action is at the other extremity of this essential part of the arrangement, namely, where oxygen goes to the electrolyte*. The first may be considered as a case where the current is put into motion by the abstraction of oxygen from hydrogen, the latter by that of hydrogen from oxygen. The direction of the electric current is in both cases the same, when referred to the direction in which the elementary particles of the electrolyte are moving (923. 962.), and both are equally in accordance with the hypothetical view of the inductive action of the particles just described (1740.).

1743. In such a view of voltaic excitement, the action of the particles may be divided into two parts, that which occurs whilst the force in a particle of oxygen is rising towards a par-

* Philosophical Magazine, 1833, xii. 225, 315. See also De la Rive's results with peroxide of manganese. *Annales de Chimie*, 1836, lxi. p. 40.—*Dec.* 1838.

tion of zinc acting on it, and falling towards the particle of hydrogen with which it is associated (this being the progressive period of the inductive action), and that which occurs when the change of association takes place, and the particle of oxygen leaves the hydrogen and combines with the zinc. The former appears to be that which produces the current, or if there be no current, produces the state of tension at the termination of the battery; whilst the latter, by terminating for the time the influence of the particles which have been active, allows of others coming into play, and so the effect of current is continued.

1744. It seems highly probable, that excitement by friction may very frequently be of the same character. Wollaston endeavoured to refer such excitement to chemical action*; but if by chemical action ultimate union of the acting particles is intended, then there are plenty of cases which are opposed to such a view. Davy mentions some such, and for my own part I feel no difficulty in admitting other means of electrical excitement than chemical action, especially if by chemical action is meant a final combination of the particles.

1745. Davy refers experimentally to the opposite states which two particles having opposite chemical relations can assume when they are brought into the close vicinity of each other, but *not* allowed to combine†. This, I think, is the first part of the action already described (1743.); but in my opinion it cannot give rise to a continuous current unless combination take place, so as to allow other particles to act successively in the same manner, and not even then unless one set of the particles be present as an element of an electrolyte (923. 963.); *i. e.* mere quiescent contact alone without chemical action does not in such cases produce a *current*.

1746. Still it seems very possible that such a relation may produce a high charge, and thus give rise to excitement by friction. When two bodies are rubbed together to produce electricity in the usual way, one at least must be an insulator. During the act of rubbing, the particles of opposite kinds must be brought more or less closely together, the few which are most favourably circumstanced being in such close contact as to be short only of that which is consequent upon chemical combination. At such moments they may acquire by their

* Philosophical Transactions, 1801, p. 427.

† Ibid. 1807, p. 34.

mutual induction (1740.) and partial discharge to each other, very exalted opposite states, and when, the moment after, they are by the progress of the rub removed from each other's vicinity, they will retain this state if both bodies be insulators, and exhibit them upon their complete separation.

1747. All the circumstances attending friction seem to me to favour such a view. The irregularities of form and pressure will cause that the particles of the two rubbing surfaces will be at very variable distances, only a few at once being in that very close relation which is probably necessary for the development of the forces; further, those which are nearest at one time will be further removed at another, and others will become the nearest, and so by continuing the friction many will in succession be excited. Finally, the lateral direction of the separation in rubbing seems to me the best fitted to bring many pairs of particles, first of all into that close vicinity necessary for their assuming the opposite states by relation to each other, and then to remove them from each other's influence whilst they retain that state.

1748. It would be easy, on the same view, to explain hypothetically, how, if one of the rubbing bodies be a conductor, as the amalgam of an electrical machine, the state of the other when it comes from under the friction is (as a mass) exalted; but it would be folly to go far into such speculation before that already advanced has been confirmed or corrected by fit experimental evidence. I do not wish it to be supposed that I think all excitement by friction is of this kind; on the contrary, certain experiments lead me to believe, that in many cases, and perhaps in all, effects of a thermo-electric nature conduce to the ultimate effect; and there are very probably other causes of electric disturbance influential at the same time, which we have not as yet distinguished.

Royal Institution,
June 1838.

THE END.

INDEX.

N.B. A dash rule represents the *italics* immediately preceding it. The references are sometimes to the individual paragraph, and sometimes to that in conjunction with those which follow.

- ABSOLUTE* charge of matter, 1169.
 — quantity of electricity in matter, 852, 861, 873.
 Acetate of potassa, its electrolysis, 749.
 Acetates, their electrolysis, 774.
 Acetic acid, its electrolysis, 773.
Acid, nitric, formed in air by a spark, 324.
 —, or alkali, alike in exciting the pile, 932.
 —, transference of, 525.
 —, *for battery*, its nature and strength, 1128, 1137.
 — —, nitric, the best, 1138.
 — —, effect of different strengths, 1139.
 — *in voltaic pile*, does not evolve the electricity, 925, 933.
 — —, its use, 925.
 Acids and bases, their relation in the voltaic pile, 927, 933.
 Active battery, general remarks on, 1034, 1136.
 Adhesion of fluids to metals, 1038.
 Advantages of a new voltaic battery, 1132.
Affinities, chemical, opposed voltaically, 891, 904, 910.
 —, their relation in the active pile, 949.
Air, its attraction by surfaces, 622.
 —, *charge of*, 1173.
 —, —, by brush, 1434, 1441.
 —, —, by glow, 1537, 1543.
 —, convective currents in, 1572, 1576, 1581.
 —, dark discharge in, 1548.
 —, disruptive discharge in, 1359, 1406, 1425, 1526.
 —, induction in, 1208, 1215, 1284, 1362.
 —, its insulating and conducting power, 441, 1332, 1336, 1362.
 —, its rarefaction facilitates discharge, 1375.
 —, electrified, 1443.
- Air*, electro-chemical decompositions in, 454, 1623.
 —, hot, discharges voltaic battery, 271, 274.
 —, poles of, 455, 461, 559.
 —, *positive and negative* brush in, 1467, 1472, 1476.
 —, — glow in, 1526, 1530.
 —, — spark in, 1485.
 —, rarefied, brush in, 1451, 1456.
 —, retention of electricity on conductors by, 1377, 1398.
 —, *specific inductive capacity of*, 1284.
 —, —, not varied by temperature or pressure, 1287, 1288.
Alkali has strong exciting power in voltaic pile, 884, 931, 941.
 —, transference of, 525.
Amalgamated zinc, its condition, 1000.
 —, how prepared, 863.
 —, its valuable use, 863, 999.
 —, battery, 1001.
Ammonia, nature of its electrolysis, 748.
 —, solution of, a bad conductor, 554, 748.
 Ampère's inductive results, 78, 255, 379 *note*.
Anions defined, 665, 824.
 —, table of, 847.
 — related through the entire circuit, 963.
 —, their action in the voltaic pile, 924.
 —, their direction of transfer, 962.
 Anode defined, 663.
Antimony, its relation to magneto-electric induction, 139.
 —, chlorine of, not an electrolyte, 690, 796.
 —, oxide of, how affected by the electric current, 801.
 —, *supposed new protoxide*, 693.
 — — sulphuret, 694.
Animal electricity, its general characters considered, 351.

- Animal electricity* is identical with other electricities, 351, 360.
- , its chemical force, 355.
 - , enormous amount, 359.
 - , evolution of heat, 353.
 - , magnetic force, 354.
 - , physiological effects, 357.
 - , spark, 358.
 - , tension, 352.
- Apparatus, inductive, 1187. *See* Inductive apparatus.
- Arago's magnetic phenomena*, their nature, 81, 120.
- , reason why no effect if no motion, 126.
 - , direction of motion accounted for, 121.
 - , due to induced electric currents, 119, 248.
 - , like electro-magnetic rotations in principle, 121.
 - , not due to direct induction of magnetism, 128, 138, 215, 243, 248.
 - , obtained with electro-magnets, 129.
 - , produced by conductors only, 130, 215.
 - , time an element in, 124.
 - , Babbage and Herschel's results explained, 127.
- Arago's experiment, Sturgeon's form of, 249.
- Associated voltaic circles, 989.
- Atmospheric balls of fire*, 1641.
- , electricity, its chemical action, 336.
- Atomic number judged of from electro-chemical equivalent, 851.
- Atoms of matter*, 869, 1703.
- , their electric power, 856, 860.
- Attraction of particles, its influence in Döbereiner's phenomena, 619.
- Attractions*, electric, their force, 1622 *note*.
- , *chemic, produce* current force, 852, 918, 947, 956, 1741.
 - , —, local force, 852, 921, 947, 959, 1739.
 - , hygrometric, 621.
- Aurora borealis referred to magneto-electric induction, 192.
- Axis of power, the electric current an, 517, 1627, 1642.
- Balls of fire, atmospheric, 1641.
- Barlow's revolving globe, magnetic effects explained, 137, 160.
- Barry, decomposed bodies by atmospheric electricity, 338.
- Bases and acids, their relation in the pile, 927.
- Battery, Leyden, that generally used, 291.
- Battery, voltaic*, its nature, 856, 989.
- , *origin of its power*, 878, 916.
 - , —, not in contact, 887, 915.
 - , —, chemical, 879, 916, 919, 1741.
 - , —, oxidation of the zinc, 919, 944.
- Battery, voltaic*, its circulating force, 858, 1120.
- , its local force, 1120.
 - , quantity of electricity circulating, 990.
 - , intensity of electricity circulating, 990, 993.
 - , *intensity of its current*, 909, 994.
 - , —, increased, 905, 989.
 - , *its diminution in power*, 1035.
 - , —, *from* adhesion of fluid, 1003, 1036.
 - , —, —, peculiar state of metal, 1040.
 - , —, —, exhaustion of charge, 1042.
 - , —, —, irregularity of plates, 1045, 1146.
 - , use of metallic contact in, 893, 896.
 - , *electrolytes essential to it*, 921.
 - , —, why, 858, 923.
 - , state of metal and electrolyte before contact, 946.
 - , conspiring action of associated affinities, 989.
 - , purity of its zinc, 1144.
 - , use of amalgamated zinc in, 999.
 - , *plates, their number*, 1151.
 - , —, size, 1154.
 - , —, vicinity, 1148.
 - , —, immersion, 1150.
 - , —, relative age, 1146.
 - , —, foulness, 1145.
 - , *excited by acid*, 880, 926, 1137.
 - , —, alkali, 931, 934, 941.
 - , —, sulphuretted solutions, 943.
 - , the acid, its use, 925.
 - , acid for, 1128, 1137.
 - , nitric acid best for, 1137.
 - , construction of, 989, 1001, 1121.
 - , with numerous alternations, 989.
 - , Hare's, 1123.
 - , general remarks on, 1034, 1136.
 - , simultaneous decompositions with, 1156.
 - , practical results with, 1136.
 - , *improved*, 1001, 1006, 1120.
 - , —, its construction, 1124.
 - , —, power, 1125, 1128.
 - , —, advantages, 1132.
 - , —, disadvantages, 1132.
- Batteries, voltaic, compared, 1126.
- Beequerel, his important secondary results, 745, 781.
- Berzelius, his view of combustion, 870, 959.
- Biot's theory of electro-chemical decomposition, 486.
- Bismuth, its relation to magneto-electric induction, 139.
- Bodies* classed in relation to the electric current, 823.

- Bodies* classed in relation to magnetism, 255.
 — electrolyzable, 824.
Bonijol decomposed substances by atmospheric electricity, 336.
Boracic acid a bad conductor, 408.
Brush, electric, 1425.
 —, produced, 1425.
 —, not affected by nature of conductors, 1454, 1473.
 —, is affected by the dielectrics, 1455, 1463, 1475.
 —, not dependent on current of air, 1440.
 —, proves molecular action of dielectric, 1449, 1450.
 —, its analysis, 1427, 1433.
 —, nature, 1434, 1441, 1447.
 —, form, 1428, 1449, 1451.
 —, *ramifications*, 1439.
 —, —, their coalescence, 1453.
 —, sound, 1426, 1431.
 —, requisite intensity for, 1446.
 —, has sensible duration, 1437.
 —, is intermittent, 1427, 1431, 1451.
 —, *light of*, 1444, 1445, 1451.
 —, —, in different gases, 1446, 1454.
 —, dark? 1444, 1552.
 —, passes into spark, 1448.
 —, spark and glow relation of, 1533, 1539, 1542.
 —, in gases, 1454, 1463, 1476.
 —, oxygen, 1457, 1476.
 —, nitrogen, 1458, 1476.
 —, hydrogen, 1459, 1476.
 —, coal-gas, 1460, 1476.
 —, carbonic acid gas, 1461, 1476.
 —, muriatic acid gas, 1462, 1476.
 —, rare air, 1451, 1455, 1474.
 —, oil of turpentine, 1452.
 —, positive, 1455, 1467, 1484.
 —, *negative*, 1468, 1472, 1484.
 —, —, of rapid recurrence, 1468, 1491.
 —, positive and negative in different gases, 1455, 1475, 1506.
- Capacity, specific inductive*, 1252.
 —. See *Specific inductive capacity*.
- Carbonic acid gas* facilitates formation of spark, 1463.
 —, brush in, 1461, 1476.
 —, glow in, 1534.
 —, spark in, 1422, 1463.
 —, *positive and negative brush* in, 1476.
 —, — discharge in, 1516.
 —, non-interference of, 645, 652.
- Carbonic oxide gas*, interference of, 645, 652.
- Carrying discharge*, 1562.
 —. See *Discharge convective*.
- Cathode* described, 663, 824.
Cations, or eathions, described, 665, 824.
 —, table of, 847.
 —, direction of their transfer, 962.
 —, are in relation through the entire circuit, 963.
- Characters of electricity*, table of, 360.
 — the electric current, constant, 1618, 1627.
 — voltaic electricity, 268.
 — ordinary electricity, 284.
 — magneto-electricity, 343.
 — thermo-electricity, 349.
 — animal electricity, 351.
- Charge, free*, 1684.
 — is always induction, 1171, 1177, 1300, 1682.
 — on surface of conductors; why, 1301.
 —, *influence of form* on, 1302.
 —, — distance on, 1303.
 —, loss of, by convection, 1569.
 —, removed from good insulators, 1203.
 — of matter absolute, 1169.
 — of air, 1173.
 — by brush, 1434, 1441.
 — by glow, 1526, 1537, 1543.
 — of particles in air, 1564.
 — of oil of turpentine, 1172.
 — of inductive apparatus divided, 1208.
 —, residual, of a Leyden jar, 1249.
 —, *chemical, for battery*, good, 1137.
 —, —, weak and exhausted, 1042, 1143.
- Chemical action*, the, exciting the pile is oxidation, 921.
 — *superinduced by metals*, 564.
 — —, platina, 564, 617, 630.
 — tested by iodide of potassium, 315.
- Chemical actions*, distant, opposed to each other, 891, 910, 1007.
- Chemical affinity* influenced by mechanical forces, 656.
 — transferable through metals, 918.
 — statical or local, 852, 921, 947, 959.
 — current, 852, 918, 947, 996.
- Chemical decomposition by voltaic electricity*, 278, 450, 661.
 — common electricity, 309, 453.
 — magneto-electricity, 346.
 — thermo-electricity, 349.
 — animal electricity, 355.
 —. See *Decomposition electro-chemical*.
- Chemical and electrical forces* identical, 877, 918, 947, 960, 965, 1031.
- Chloride of antimony* not an electrolyte, 690.
 — *lead*, its electrolysis, 794, 815.
 — —, electrolytic intensity for, 978.
 — *silver*, its electrolysis, 541, 813, 902.
 — —, electrolytic intensity for, 979.
 — tin, its electrolysis, 789, 819.

- Chlorides in solution*, their electrolysis, 766.
 — fusion, their electrolysis, 789, 813.
Circle of anions and cations, 963.
Circles, simple voltaic, 875.
 —, associated voltaic, 989.
Circuit, voltaic, relation of bodies in, 962.
Classification of bodies in relation to magnetism, 255.
 — the electric current, 823, 847.
Cleanliness of metals and other solids, 633.
Clean platina, its characters, 633, 717.
 — its power of effecting combination, 590, 605, 617, 632.
 —, —. See *Plates of platina*.
Coal gas, brush in, 1460.
 —, dark discharge in, 1556.
 —, positive and negative brush in, 1476.
 —, positive and negative discharge in, 1515.
 —, spark in, 1422.
Colladon on magnetic force of common electricity, 289.
Collectors, magneto-electric, 86.
Combination effected by metals, 564, 608.
 — solids, 564, 618.
 — poles of platina, 566.
 — platina, 564, 568, 571, 590, 630.
 — —, as plates, 569.
 — —, as sponge, 609, 636.
 — —, cause of, 590, 616, 625, 656.
 — —, how, 630.
 — —, interferences with, 638, 652, 655.
 — — retarded by olefiant gas, 640.
 — — carbonic oxide, 645, 652.
 — — sulphuret of carbon, 650.
 — — ether, 651.
 — — other substances, 649, 653, 654.
Comparison of voltaic batteries, 1126, 1146.
Conditions, general, of voltaic decomposition, 669.
 —, new, of electro-chemical decomposition, 453.
Conducting power measured by a magnet, 216.
 — of solid electrolytes, 419.
 — of water, constant, 984.
Conduction, 418, 1320.
 —, its nature, 1320, 1326, 1611.
 —, of two kinds, 987.
 —, preceded by induction, 1329, 1332, 1338.
 — and insulation, cases of the same kind, 1320, 1326, 1336, 1338, 1561.
 —, its relation to the intensity of the current conducted, 419.
 — common to all bodies, 444, 449.
 — by a vacuum, 1613.
 — by lac, 1234, 1324.
 — by sulphur, 1241, 1328.
 — by glass, 1239, 1324.
Conduction by spermaceti, 1240, 1323.
 — by gases, 1336.
 — slow, 1233, 1245, 1328.
 — affected by temperature, 445, 1339.
 — by metals diminished by heat, 432, 445.
 — increased by heat, 432, 441, 445.
 — of electricity and heat, relation of, 416.
 —, simple, can occur in electrolytes, 967, 983.
 —, — with very feeble currents, 970.
 — by electrolytes without decomposition, 968, 1017, 1032.
 — and decomposition associated in electrolytes, 413, 676, 854.
 — facilitated in electrolytes, 1355.
 — by water bad, 1159.
 — improved by dissolved bodies, 984, 1355.
 —, electrolytic, stopped, 380, 1358, 1705.
 — of currents stopped by ice, 381.
 — conferred by liquefaction, 394, 410.
 — taken away by solidification, 394, 1705.
 — —, why, 910, 1705.
 —, new law of, 380, 394, 410.
 —, —, supposed exception to, 691, 1340.
 —, general results as to, 443.
Conductive discharge, 1320.
Conductors, electrolytic, 474.
 —, magneto-electric, 86.
 —, their nature does not affect the electric brush, 1454.
 —, size of, affects discharge, 1372.
 —, form of, affects discharge, 1374, 1425.
 —, distribution of electricity on, 1368.
 —, —, affected by form, 1374.
 —, —, — distance, 1364, 1371.
 —, —, — air pressure, 1375.
 —, —, irregular with equal pressure, 1378.
Constancy of the electric current, 1618.
Constitution of electrolytes as to proportions, 679, 697, 830, 1708.
 — liquidity, 394, 823.
Contact of metals not necessary for electro-lyzation, 879.
 —, its use in the voltaic battery, 893.
 — not necessary for spark, 915, 956.
Contiguous particles, their relation to induction, 1165, 1679.
 — active in electrolysis, 1349, 1703.
Convection, 1562, 1642.
 — or convective discharge. See *Discharge convective*.
Copper, iron, and sulphur eirele, 943.
Coruscations of lightning, 1464.
Coulomb's electrometer, 1180.
 —, precautions in its use, 1182, 1186, 1206.

- Crystals, induction through, 1689.
 Cube, large, electrified, 1173.
 Cubes of crystals, induction through, 1692, 1695.
 Current chemical affinity, 852, 918, 947, 996.
 Current, voltaic, without metallic contact, 879, 887.
Current, electric, 1617.
 —, defined, 282, 511.
 —, nature of, 511, 667, 1617, 1627.
 —, variously produced, 1618.
 —, produced by chemical action, 879, 916, 1741.
 —, — animals, 351.
 —, — friction, 301, 307, 311.
 —, — heat, 349.
 —, — discharge of static electricity, 296, 307, 363.
 —, — induction by other currents, 6, 1089.
 —, — — magnets, 36, 88, 344.
 —, evolved in the moving earth, 181.
 —, in the earth, 187.
 —, natural standard of direction, 663.
 —, none of one electricity, 1627, 1632, 1635.
 —, two forces everywhere in it, 1627, 1632, 1635, 1642.
 —, one, and indivisible, 1627.
 —, an axis of power, 517, 1642.
 —, constant in its characters, 1618, 1627.
 —, inexhaustibility of, 1631.
 —, its velocity in conduction, 1648.
 —, — electrolyzation, 1651.
 —, regulated by a fine wire, 853 *note*.
 —, affected by heat, 1637.
 —, stopped by solidification, 381.
 —, its section, 498, 504, 1634.
 —, — presents a constant force, 1634.
 —, produces chemical phenomena, 1621.
 —, — heat, 1625.
 —, its heating power uniform, 1630.
 —, produces magnetism, 1653.
 —, Porrett's effects produced by, 1646.
 —, induction of, 1, 6, 232, 241, 1101, 1048.
 —, —, on itself, 1048.
 —, —. See Induction of electric current.
 —, its inductive force lateral, 1108.
 —, induced in different metals, 193, 213, 201, 211.
 —, its transverse effects, 1653.
 —, — constant, 1655.
 —, its transverse forces, 1658.
 —, — are in relation to contiguous particles, 1664.
 —, —, their polarity of character, 1665.
 Current and magnet, their relation remembered, 38, *note*.
 Currents in air by convection, 1572, 1581.
 — metals by convection, 1603.
 — oil of turpentine by convection, 1595, 1598.
 Curved lines, induction in, 1215.
 Curves, magnetic, their relation to dynamic induction, 217, 232.
 Daniell on the size of the voltaic metals, 1525.
 Dark discharge, 1444, 1544.
 —. See Discharge, dark.
 Dates of some facts and publications, 139, *note after*.
 Davy's theory of electro-chemical decomposition, 482, 500.
 — electro-chemical views, 965.
 — mercurial cones, convective phenomena, 1603.
 Decomposing force alike in every section of the current, 501, 505.
 —, variation of, on each particle, 503.
 Decomposition and conduction associated in electrolytes, 413, 854.
 —, primary and secondary results of, 742, 777.
 — by common electricity, 309, 454.
 — —, precautions, 322.
 Decomposition, electro-chemical, 450, 669.
 —, nomenclature of, 661.
 —, new terms relating to, 662.
 —, its distinguishing character, 309.
 —, by common electricity, 309, 454.
 —, by a single pair of plates, 862, 897, 904, 931.
 —, by the electric current, 1621.
 —, without metallic contact, 880, 882.
 —, its cause, 891, 904, 910.
 —, not due to direct attraction or repulsion of poles, 493, 497, 536, 542, 546.
 —, dependent on previous induction, 1345.
 —, — the electric current, 493, 510, 524, 854.
 —, — intensity of current, 905.
 —, — chemical affinity of particles, 519, 525, 549.
 —, resistance to, 891, 910, 1007.
 —, intensity requisite for, 966, 1354.
 —, stopped by solidification, 380, 1358, 1705.
 —, retarded by interpositions, 1007.
 —, assisted by dissolved bodies, 1355.
 —, division of the electrolyte, 1347, 1623, 1704.
 —, transference, 519, 525, 538, 550, 1347, 1706.
 —, why elements appear at the poles, 535.

- Decomposition, electro-chemical*, uncombined bodies do not travel, 544, 546.
 —, circular series of effects, 562, 962.
 —, simultaneous, 1156.
 —, *definite*, 329, 372, 377, 504, 704, 714, 722, 726, 732, 764, 783, 807, 821, 960.
 —, — independent of variations of electrodes, 714, 722, 807, 832.
 —, necessary intensity of current, 911, 966, 1345, 1354.
 —, influence of water in, 472.
 —, in air, 454, 461, 469.
 —, some general conditions of, 669.
 —, new conditions of, 453.
 —, primary results, 742.
 —, secondary results, 702, 742, 748, 777.
 —, of acetates, 774.
 —, acetic acid, 773.
 —, ammonia, 748.
 —, *chloride of antimony*, 690, 796.
 —, — lead, 794, 815.
 —, — silver, 541, 813, 979.
 —, *chlorides in solution*, 766.
 —, — fusion 789, 813.
 —, fused electrolytes, 789.
 —, hydriodic acid and iodides, 767, 787.
 —, hydrocyanic acid and cyanides, 771.
 —, hydrofluoric acid and fluorides, 770.
 —, *iodide of lead*, 802, 818.
 —, — potassium, 805.
 —, muriatic acid, 758, 786.
 —, nitre, 753.
 —, nitric acid, 752.
 —, *oxide of antimony*, 801.
 —, — lead, 797.
 —, protochloride of tin, 789, 819.
 —, protiodide of tin, 804.
 —, sugar, gum, &c., 776.
 —, of sulphate of magnesia, 495.
 —, sulphuric acid, 757.
 —, sulphurous acid, 755.
 —, tartaric acid, 775.
 —, water, 704, 785, 807.
 —, *theory of*, 477, 1345.
 —, —, by A. de la Rive, 489, 507, 514, 543.
 —, —, Biot, 486.
 —, —, Davy, 482, 500.
 —, —, Grotthuss, 481, 499, 515.
 —, —, Hachette, 491, 513.
 —, —, Riffault and Chompré, 485, 507, 512.
 —, —, author's theory, 518, 524, 1345, 1623, 1703, 1706.
Definite decomposing action of electricity, 329, 372, 377, 504, 704, 783, 821.
 — magnetic action of electricity, 216, 362, 367, 377.
 — *electro-chemical action*, 822, 869, 960.
 —, —, general principles of, 822, 862.
 —, —, *in chloride of lead*, 815.
- Definite electro-chemical action in chloride of silver*, 813.
 —, —, in hydriodic acid, 767, 787.
 —, —, iodide of lead, 802, 818.
 —, —, muriatic acid, 758, 786.
 —, —, protochloride of tin, 819.
 —, —, water, 732, 785, 807.
 Degree in measuring electricity, proposal for, 736.
De la Rive on heat at the electrodes, 1637.
 —, his theory of electro-chemical decomposition, 489, 507, 514, 543.
Dielectrics, what, 1168.
 —, their importance in electrical actions, 1666.
 —, their relation to static induction, 1296.
 —, their condition under induction, 1369, 1679.
 —, their nature affects the brush, 1455.
 —, their specific electric actions, 1296; 1398, 1423, 1454, 1503, 1560.
 Difference of positive and negative discharge, 1465, 1480, 1485.
 Differential inductometer, 1307.
Direction of ions in the circuit, 962.
 — the electric current, 663.
 — the magneto-electric current, 114, 116.
 — the induced volta-electric current, 19, 26, 1091.
 Disruptive discharge, 1359, 1405. *See* Discharge, disruptive.
Discharge, electric, as balls of fire, 1641.
 —, of Leyden jar, 1300.
 —, *of voltaic battery by hot air*, 271, 274.
 —, — points, 272.
 —, velocity of, in metal, varied, 1333.
 —, varieties of, 1319.
 —, brush, 1425. *See* Brush.
 —, carrying, 1562. *See* Discharge, convective.
 —, conductive, 1320. *See* Conduction.
 —, dark, 1444, 1544.
 —, disruptive, 1359, 1405.
 —, electrolytic, 1343, 1622, 1704.
 —, glow, 1526. *See* Glow.
 —, positive and negative, 1465.
 —, spark, 1406. *See* Spark, electric.
Discharge, convective, 1442, 1562, 1601, 1623, 1633, 1642.
 —, in insulating media, 1562, 1572.
 —, in good conductors, 1603.
 —, *with fluid terminations in air*, 1581, 1589.
 —, — liquids, 1597.
 —, from a ball, 1576, 1590.
 —, influence of points in, 1573.
 —, *affected by mechanical causes*, 1579.
 —, — flame, 1580.
 —, with glow, 1576.
 —, *charge of a particle in air*, 1564.

- Discharge, convective*, in oil of turpentine, 1570.
 —, charge of air by, 1442, 1592.
 —, *currents produced* in air, 1572, 1581, 1591.
 —, — in oil of turpentine, 1595, 1598.
 —, direction of the currents, 1599, 1645.
 —, Porrett's effects, 1646.
 —, positive and negative, 1593, 1600, 1643.
Discharge, convective, related to electrolytic discharge, 1622, 1633.
Discharge, dark, 1444, 1544, 1560.
 —, with negative glow, 1544.
 —, between positive and negative glow, 1547.
 —, in air, 1548.
 —, muriatic acid gas, 1554.
 —, coal gas, 1556.
 —, hydrogen, 1558.
 —, nitrogen, 1559.
Discharge, disruptive, 1405.
 —, preceded by induction, 1362.
 —, determined by one particle, 1370, 1409.
 —, necessary intensity, 1409, 1553.
 —, determining intensity constant, 1410.
 —, related to particular dielectric, 1503.
 —, facilitates like action, 1417, 1435, 1453, 1553.
 —, its time, 1418, 1436, 1498, 1641.
 —, *varied by* form of conductors, 1302, 1372, 1374.
 —, — change in the dielectric, 1395, 1422, 1454.
 —, — rarefaction of air, 1365, 1375, 1451.
 —, — temperature, 1367, 1380.
 —, — distance of conductors, 1303, 1364, 1371.
 —, — size of conductors, 1372.
 —, in liquids and solids, 1403.
 —, *in different gases*, 1381, 1388, 1421.
 —, — not alike, 1395.
 —, —, specific differences, 1399, 1422, 1687.
 —, —, *positive and negative*, 1393, 1399, 1465, 1524.
 —, —, distinctions, 1467, 1475, 1482.
 —, —, differences, 1485, 1501.
 —, —, relative facility, 1496, 1520.
 —, —, dependent on the dielectric, 1503.
 —, —, in different gases, 1506, 1510, 1518, 1687.
 —, —, of voltaic current, 1524.
 —, brush, 1425.
 —, collateral, 1412.
 —, dark, 1444, 1544, 1560.
 —, glow, 1526.
 —, spark, 1406.
- Discharge*, theory of, 1368, 1406, 1434.
Discharge, electrolytic, 1164, 1343, 1621, 1703, 1706.
 —, previous induction, 1345, 1351.
 —, necessary intensity, 912, 966, 1346, 1354.
 —, division of the electrolyte, 1347, 1704.
 —, stopped by solidifying the electrolyte, 380, 1358, 1705.
 —, —, facilitated by added bodies, 1355.
 —, in curved lines, 521, 1216, 1351.
 —, proves action of contiguous particles, 1349.
 —, positive and negative, 1525.
 —, velocity of electric current in, 1650.
 —, related to convective discharge, 1622.
 —, theory of, 1344, 1622, 1704.
 Discharging train generally used, 292.
 Disruptive discharge, 1405. *See* Discharge, disruptive.
 Dissimulated electricity, 1684.
Distance, its influence in induction, 1303, 1364, 1371.
 — over disruptive discharge, 1364, 1371.
 Distant chemical actions, connected and opposed, 891, 909.
 Distinction of magnetic and magneto-electric action, 138, 215, 243, 253.
 Division of a charge by inductive apparatus, 1208.
 Döbereiner on combination effected by platina, 609, 610.
 Dulong and Thenard on combination by platina and solids, 609, 611.
 Dust, charge of its particles, 1567.
- Earth, natural magneto-electric induction in, 181, 190, 192.
Elasticity of gases, 626.
 — gaseous particles, 658.
Electric brush, 1425. *See* Brush, electric.
 — condition of particles of matter, 862, 1669.
 — conduction, 1320. *See* Conduction.
 — current defined, 283, 511.
 — —, nature of, 511, 1617, 1627.
 — —. *See* Current, electric.
 — —, *induction of*, 6, 232, 241, 1048, 1101. *See* Induction of electric current.
 — —, induction of, on itself, 1048.
 — discharge, 1319. *See* Discharge.
 — force, nature of, 1667. *See* Forces.
 — induction, 1162. *See* Induction.
 — inductive capacity, 1252. *See* Specific inductive capacity.
 — polarity, 1685. *See* Polarity, electric.
 — spark, 1406. *See* Spark, electric.
 — and magnetic forces, their relation, 118, 1411, 1653, 1658, 1709, 1731.

- Electrics, charge of, 1171, 1247.
Electrical excitation, 1737. *See* Excitation.
 — machine generally used, 290.
 — battery generally used, 291.
 — and chemical forces identical, 877,
 917, 947, 960, 965, 1031.
Electricities, their identity, however ex-
 cited, 265, 360.
 —, one or two, 516, 1667.
 —, *two*, 1163.
 —, —, their independent existence,
 1168.
 —, —, their inseparability, 1168, 1177,
 1244.
 —, —, never separated in the current,
 1628.
Electricity, quantity of, in matter, 852, 861.
 —, *its distribution on conductors*, 1368.
 —, — *influenced by form*, 1302, 1374
 —, — — distance, 1303, 1364, 1371.
 —, — — air's pressure, 1375.
 —, relation of a vacuum to, 1613.
 —, dissimulated, 1684.
 —, common and voltaic, measured, 361,
 860.
 —, *its definite decomposing action*, 329,
 377, 783, 1621.
 —, — heating action, 1625.
 —, — magnetic action, 216, 366.
 —, animal, its characters, 351.
 —, magneto-, its characters, 343.
 —, ordinary, its characters, 284.
 —, thermo-, its characters, 349.
 —, voltaic, its characters, 268.
Electricity from magnetism, 27, 36, 57, 83,
 135, 140.
 —, *on magnetisation of soft iron by cur-*
rents, 27, 34, 57, 113.
 — — magnets, 36, 44.
 —, *employing permanent magnets*, 39,
 84, 112.
 —, — terrestrial magnetic force, 140,
 150, 161.
 —, — *moving conductors*, 55, 83, 132,
 109, 149, 161, 171.
 —, — — essential condition, 217.
 — *by revolving plate*, 83, 149, 240.
 — — a constant source of electricity,
 89, 90, 154.
 — —, law of evolution, 114.
 — —, direction of the current evolved,
 91, 99, 110, 116, 117.
 — —, course of the currents in the
 plate, 123, 150.
 — by a revolving globe, 137, 160.
 — by plates, 94, 101.
 — by a wire, 49, 55, 109, 112, 137.
 —, conductors and magnet may move
 together, 218.
 —, *current produced in a single wire*,
 49, 55, 170.
Electricity from magnetism a ready source
 of electricity, 46, *note*.
 —, — momentary, 28, 30, 47.
 —, — permanent, 89, 154.
 —, — deflects galvanometer, 30, 39, 46.
 —, — makes magnets, 34.
 —, — shock of, 56.
 —, — spark of, 32.
 —, — traverses fluids, 23, 33.
 —, current produced, its direction, 30,
 38, 41, 52, 53, 54, 78, 91, 99, 114, 142,
 166, 220, 222.
 —, effect of approximation and recess-
 ion, 18, 39, 50.
 —, the essential condition, 217.
 —, general expression of the effects, 256.
 — from magnets alone, 220.
Electricity of the voltaic pile, 875.
 — *its source*, 875.
 — —, not metallic contact, 887, 915.
 — —, is in chemical action, 879, 916,
 919, 1738, 1741.
Electro-chemical decomposition, 450, 661.
 —, nomenclature, 661.
 —, general conditions of, 669.
 —, new conditions of, 453.
 —, influence of water in, 472.
 —, primary and secondary results, 742.
 —, definite, 732, 783.
 —, theory of, 477.
 —. *See also* Decomposition, electro-
 chemical.
Electro-chemical equivalents, 824, 833, 835,
 855.
 —, table of, 847.
 —, how ascertained, 837.
 — always consistent, 835.
 — same as chemical equivalents, 836, 839.
 — able to determine atomic number, 851.
 Electro-chemical excitation, 878, 919, 1738.
 Electrode defined, 662.
Electrodes affected by heat, 1637.
 —, *varied in size*, 714, 722.
 —, — nature, 807.
 —. *See* Poles.
 Electrolysis, resistance to, 1007.
Electrolyte defined, 664.
 — *exciting, solution of acid*, 881, 925.
 — — alkali, 931, 941.
 — *exciting, water*, 944, 945.
 — — sulphuretted solution, 943.
Electrolytes, their necessary constitution,
 669, 823, 829, 858, 921, 1347, 1708.
 — consist of single proportionals of ele-
 ments, 679, 697, 830, 1707.
 — *essential to voltaic pile*, 921.
 — —, why, 858, 923.
 — conduct and decompose simulta-
 neously, 413.
 — can conduct feeble currents without
 decomposition, 967.

- Electrolytes*, as ordinary conductors, 970, 983, 1344.
 —, solid, their insulating and conducting power, 419.
 —, real conductive power not affected by dissolved matters, 1356.
 —, needful conducting power, 1158.
 — are good conductors when fluid, 394, 823.
 — *non-conductors when solid*, 381, 394.
 —, why, 910, 1705.
 —, the exception, 1032.
 —, their particles polarize as wholes, 1700.
 —, polarized light sent across, 951.
 —, relation of their moving elements to the passing current, 923, 1704.
 —, their resistance to decomposition, 891, 1007, 1705.
 — and metal, their states in the voltaic pile, 946.
 —, salts considered as, 698.
 —, acids not of this class, 681.
Electrolytic action of the current, 478, 518, 1620.
 — conductors, 474.
 — discharge, 1343. *See* Discharge, electrolytic.
 — induction, 1164, 1343.
 — *intensity*, 911, 966, 983.
 — — varies for different bodies, 912, 986, 1354.
 — — of chloride of lead, 978.
 — — chloride of silver, 979.
 — — sulphate of soda, 975.
 — — water, 968, 981.
 — —, its natural relation, 987½.
Electrolyzation, 450, 661, 1164, 1347, 1704.
See Decomposition electro-chemical.
 — defined, 664.
 — facilitated, 394, 417, 549, 1355.
 — in a single circuit, 863, 879.
 —, intensity needful for, 919, 966.
 — of chloride of silver, 541, 979.
 — sulphate of magnesia, 495.
 — and conduction associated, 413, 676.
 Electro-magnet, inductive effects in, 1060.
 Electro-magnetic induction definite, 216, 366.
Electrometer, *Coulomb's*, described, 1180.
 —, how used, 1183.
Electro-ionic state, 60, 231, 242, 1114, 1661, 1729.
 — considered common to all metals, 66.
 — — conductors, 76.
 — is a state of tension, 71.
 — is dependent on particles, 73.
 Elementary bodies probably ions, 849.
Elements evolved by force of the current, 493, 520, 524.
 — at the poles, why, 535.
Elements determined to either pole, 552, 681, 757.
 —, transference of, 454, 538.
 —, if not combined, do not travel, 544, 546.
Equivalents, electro-chemical, 824, 833, 855.
 —, chemical and electro-chemical, the same, 836, 839.
 Ether, interference of, 651.
Evolution of electricity, 1162, 1737.
 — of one electric force impossible, 1175.
 — of elements at the poles, why, 535.
Excitation, electrical, 1737.
 — by chemical action, 878, 916, 1739.
 — by friction, 1744.
 Exclusive induction, 1681.
 Flame favours convective discharge, 1580.
 Flowing water, electric currents in, 190.
 Fluid terminations for convection, 1581.
 Fluids, their adhesion to metals, 1038.
 Fluoride of lead, hot, conducts well, 1340.
Force, chemical, local, 947, 959, 1739.
 —, circulating, 917, 947, 996, 1120.
Force, electric, nature of, 1163, 1667.
 —, inductive, of currents, its nature, 60, 1113, 1735.
Forces, electric, two, 1163.
 —, inseparable, 1163, 1177, 1244, 1627.
 — and chemical, are the same, 877, 916.
 — and magnetic, relation of, 1411, 1653, 1658, 1709.
 — —, are they essentially different? 1663, 1731.
Forces, exciting, of voltaic apparatus, 887, 916.
 —, exalted, 905, 994, 1138, 1148.
Forces, polar, 1665.
 — of the current, direct, 1620.
 — —, lateral or transverse, 1653, 1709.
Form, its influence on induction, 1302, 1374.
 — discharge, 1372, 1374.
 Fox, his terrestrial electric currents, 187.
Friction electricity, its characters, 284.
 —, excitement by, 1744.
 Fusion, conduction consequent upon, 394, 402.
 Fusinieri, on combination effected by platina, 613.
Galvanometer, affected by common electricity, 289, 366.
 —, a correct measure of electricity, 367, *note*.
Gases, their elasticity, 626, 657.
 —, conducting power, 1336.
 —, *insulating power*, 1381, 1507.
 —, — not alike, 1395, 1508.
 —, *specific inductive capacity*, 1283, 1290.

- Gases, specific inductive capacity* alike in all, 1292.
 —, specific influence on brush and spark, 1463, 1687.
Gases, discharge, disruptive, through, 1381.
 —, brush in, 1454.
 —, spark in, 1421.
 —, *positive and negative brushes in*, 1475.
 —, —, their differences, 1476.
 —, positive and negative discharge in, 1393, 1506, 1687.
 —, solubility of, in cases of electrolyzation, 717, 728.
 — from water, spontaneous recombination of, 566.
 —, mixtures of, affected by platina plates, 571.
 —, mixed, relation of their particles, 625.
General principles of definite electrolytic action, 822.
 — remarks on voltaic batteries, 1034, 1136.
 — *results as to conduction*, 443.
 — — induction, 1295.
Glass, its conducting power, 1239.
 —, its specific inductive capacity, 1271.
 —, *its attraction for air*, 622.
 —, — water, 1254.
Globe, revolving, of Barlow, effects explained, 137, 160.
 —, is magnetic, 164.
Glow, 1405, 1526.
 —, produced, 1527.
 —, positive, 1527.
 —, negative, 1530.
 —, favoured by rarefaction of air, 1529.
 —, is a continuous charge of air, 1526, 1537, 1543.
 —, occurs in all gases, 1534.
 — accompanied by a wind, 1535.
 —, its nature, 1543.
 —, discharge, 1526.
 —, brush and spark relation of, 1533, 1538, 1539, 1542.
 Grotthuss' theory of electro-chemical decomposition, 481, 499, 515.
Growth of a brush, 1437.
 — spark, 1553.
- Hachette's view of electro-chemical decomposition, 491.
 Hare's voltaic trough, 1123, 1132.
 Harris on induction in air, 1363.
Heat affects the two electrodes, 1637.
 — increases the conducting power of some bodies, 432, 438, 1340.
 —, its conduction related to that of electricity, 416.
 —, as a result of the electric current, 853, *note*, 1625, 1630.
 — *evolved by animal electricity*, 353.
- Heat evolved by common electricity*, 287.
 — — magneto-electricity, 344.
 — — thermo-electricity, 349.
 — — voltaic electricity, 276.
 Helix, inductive effects in, 1061, 1094.
 Hydriodic acid, its electrolyses, 767, 787.
 Hydrocyanic acid, its electrolyses, 771, 788.
 Hydrofluoric acid, not electrolysable, 770.
Hydrogen, brush in, 1459.
 —, *positive and negative brush in*, 1476.
 —, — discharge in, 1514.
Hydrogen and oxygen combined by platina plates, 570, 605.
 — spongy platina, 609.
- Ice, its conducting power*, 419.
 — a non-conductor of voltaic currents, 381.
 Iceland crystal, induction across, 1695.
Identity of electricities, 265, 360.
 — of chemical and electrical forces, 877, 917, 947, 961, 1031.
 Ignition of wire by electric current, 853, *note*, 1630.
 Improved voltaic battery, 1006, 1120.
 Increase of cells in voltaic battery, effect of, 990.
 Inducteous surfaces, 1483.
Induction apparatus, 1187.
 —, fixing the stem, 1190, 1193, 1200.
 —, precautions, 1194, 1199, 1213, 1232, 1250.
 —, removal of charge, 1203.
 —, retention of charge, 1205, 1207.
 —, a charge divided, 1208.
 —, peculiar effects with, 1233.
Induction, static, 1161.
 —, an action of contiguous particles, 1165, 1231, 1253, 1295, 1450, 1668, 1679.
 —, consists in a polarity of particles, 1298, 1670, 1679.
 —, continues only in insulators, 1298, 1324, 1338.
 —, intensity of, sustained, 1362.
 —, *influenced by the form of conductors*, 1302.
 —, — distance of conductors, 1303.
 —, — relation of the bounding surfaces, 1483.
 —, charge, a case of, 1171, 1177, 1300.
 —, exclusive action, 1681.
 —, towards space, 1614.
 —, across a vacuum, 1614.
 — *through air*, 1217, 1284.
 — — different gases, 1381, 1395.
 — — crystals, 1689.
 — — lac, 1228, 1255, 1308.
 — — metals, 1329, 1332.
 — — all bodies, 1331, 1334.
 —, *its relation to other electrical actions*, 1165, 1178.

- Induction, static, its relation to insulation*, 1324, 1362, 1368, 1678.
- , — conduction, 1320.
 - , — discharge, 1319, 1323, 1362.
 - , — electrolyzation, 1164, 1343.
 - , — intensity, 1178, 1362.
 - , — excitation, 1178, 1740.
 - , — disruptive discharge, 1362.
 - , — charge, 1177, 1299.
 - an essential general electric function, 1178, 1299.
 - , general results as to, 1295.
 - , theory of, 1165, 1231, 1295, 1667, 1669.
 - *in curved lines*, 1166, 1215, 1679.
 - —, *through air*, 1218, 1449.
 - —, — other gases, 1226.
 - —, — lac, 1228.
 - —, — sulphur, 1228.
 - —, — oil of turpentine, 1227.
- Induction, specific*, 1167, 1252, 1307.
- , *the problem stated*, 1252.
 - , — solved, 1307.
 - , *of air*, 1284.
 - , —, invariable, 1287, 1288.
 - , *of gases*, 1283, 1290.
 - , — alike in all, 1292.
 - , *of shell-lac*, 1256, 1269.
 - , glass, 1271.
 - , sulphur, 1275.
 - , spermaceti, 1279.
 - , certain fluid insulators, 1280.
- Induction of electric currents*, 6, 34, 232, 241, 1048, 1089, 1101, 1660, 1718.
- , on causing the principal current, 10, 238, 1101.
 - , on stopping the principal current, 10, 17, 238, 1087, 1100.
 - by approximation, 18, 236.
 - by increasing distance, 19, 237.
 - *effective through conductors*, 1719, 1721, 1735.
 - — insulators, 1719, 1722, 1735.
 - in different metals, 193, 202, 211, 213.
 - in the moving earth, 181.
 - in flowing water, 190.
 - in revolving plates, 85, 240.
 - , *the induced current, its direction*, 26, 232.
 - , — duration, 19, 47, 89.
 - , —, traverses fluids, 20, 23.
 - , —, its intensity in different conductors, 183, 193, 201, 211, 213.
 - , —, not obtained by Leyden discharge, 24.
 - , Ampère's results, 78, 255, 379, *note*.
- Induction of a current on itself*, 1048, 1109.
- , apparatus used, 1052.
 - *in a long wire*, 1064, 1068, 1092, 1118.
 - , — doubled wire, 1096.
- Induction of a current on itself, in a helix*, 1053, 1061.
- in doubled helices, 1096.
 - in an electro magnet, 1056, 1060.
 - , wire and helix compared, 1065.
 - , short wire, effects with, 1067.
 - , action momentary, 1070, 1091, 1100.
 - , causes no permanent change in the current, 1071.
 - not due to momentum, 1077.
 - , induced current separated, 1078, 1089.
 - , *effect at breaking contact*, 1060, 1081, 1084, 1087.
 - , — making contact, 1101, 1106.
 - , *effects produced*, shock, 1060, 1064, 1079.
 - , — spark, 1060, 1064, 1080.
 - , — chemical decomposition, 1084.
 - , — ignition of wire, 1081, 1104.
 - , cause is in the conductor, 1059, 1070.
 - , general principles of the action, 1093, 1107.
 - , direction of the forces lateral, 1108.
- Induction, magnetic*, 255, 1658, 1710.
- , by intermediate particles, 1663, 1710, 1729, 1735.
 - , *through quiescent bodies*, 1712, 1719, 1720, 1735.
 - , — moving bodies, 1715, 1716, 1719.
 - and magneto-electric, distinguished; 138, 215, 243, 253.
- Induction, magneto-electric*, 27, 58, 81, 140, 193, 1709. *See* Arago's magnetic phenomena.
- , magneto-electric, 58.
 - , electrolytic, 1164, 1345, 1702, 1740.
 - , volta-electric, 26.
- Inductive capacity, specific, 1167, 1252.
- Inductive force of currents lateral*, 26, 1108.
- , its nature, 1113, 1660, 1663, 1709.
- Inductive force, lines of*, 1231, 1297, 1304.
- , often curved, 1219, 1224, 1230.
 - , exhibited by the brush, 1449.
 - , their lateral relation, 1231, 1297, 1304.
 - , their relation to magnetism, 1411, 1658, 1709.
- Inductometer, differential, 1307, 1317.
- Inductric surfaces, 1483.
- Inexhaustible nature of the electric current, 1631.
- Inseparability of the two electric forces, 1163, 1177, 1244, 1628.
- Insulating power of different gases, 1388, 1395, 1507.
- Insulation*, 1320, 1359, 1361.
- , its nature, 1321.
 - is sustained induction, 1324.
 - , degree of induction sustained, 1362.
 - *dependent on the dielectrics*, 1368.

- Insulation dependent on the distance in air*, 1303, 1364, 1371.
 ——— density of air, 1365, 1375.
 ——— induction, 1368.
 ——— form of conductors, 1302, 1374.
 ———, as affected by temperature of air, 1367, 1380.
 ——— in different gases, 1381, 1388.
 ——— differs, 1395.
 ——— in liquids and solids, 1403.
 ——— in metals, 1328, 1331, 1332.
 ——— and conduction not essentially different, 1320, 1326, 1336, 1338, 1561.
 ———, its relation to induction, 1324, 1362, 1368, 1678.
- Insulators*, liquid, good, 1172.
 ———, solid, good, 1254.
 ———, the best conduct, 1233, 1241, 1245, 1247, 1254.
 ——— tested as to conduction, 1255.
 ——— and conductors, relation of, 1328, 1334, 1338.
- Intensity*, its influence in conduction, 419.
 ———, inductive, how represented, 1370.
 ———, relative, of magneto-electric currents, 183, 193, 211, 213.
 ——— of disruptive discharge constant, 1410.
 ———, electrolytic, 912, 966, 983, 1354.
 ——— necessary for electrolyzation, 911, 966.
 ——— of the current of single circles, 904.
 ——— increased, 906.
 ——— of electricity in the voltaic battery, 990, 993.
 ——— of voltaic current increased, 906, 990.
- Interference with combining power of platinum*, 638, 655.
 ——— by olefiant gas, 640.
 ——— carbonic oxide, 645.
 ——— sulphuret of carbon, 650.
 ——— ether, 651.
- Interpositions*, their retarding effects, 1018.
- Iodides in solution*, their electrolysis, 769.
 ——— fusion, their electrolysis, 802, 813.
- Iodide of lead*, electrolysed, 802, 818.
 ——— of potassium, test of chemical action, 316.
- Ions*, what, 665, 824, 833, 834, 849.
 ——— not transferable alone, 542, 547, 826.
 ———, table of, 847.
- Iron*, both magnetic and magneto-electric at once, 138, 254.
 ———, copper and sulphur circles, 943.
- Jenkin*, his shock by one pair of plates, 1049.
- Kemp*, his amalgam of zinc, 999.
- Knight*, Dr. Gowin, his magnet, 44.
- Lae*, charge removed from, 1203.
 ———, induction through, 1255.
 ———, specific inductive capacity of, 1256, 1269.
- Lae*, effects of its conducting power, 1234.
 ———, its relation to conduction and insulation, 1324.
- Lateral direction of inductive forces of currents*, 26, 1108.
 ——— forces of the current, 1653, 1709.
- Law of conduction, new*, 380, 394, 410.
 ——— magneto-electric induction, 114.
 ——— volta-electric induction, 26.
- Lead*, chloride of, electrolysed, 794, 815.
 ———, fluoride of, conducts well when heated, 1340.
 ———, iodide of, electrolysed, 802, 818.
 ———, oxide of, electrolysed, 797.
- Leyden jar*, condition of its charge, 1682.
 ———, its charge, nature of, 1300.
 ———, its discharge, 1300.
 ———, its residual charge, 1249.
- Light*, polarized, passed across electrolytes, 951.
 ———, electric, 1405, 1445, 1560, note.
 ———, ———, spark, 1406, 1553.
 ———, ———, brush, 1425, 1444, 1445.
 ———, ———, glow, 1526.
- Lightning*, 1420, 1464, 1641.
- Lines of inductive force*, 1231, 1304.
 ——— often curved, 1219, 1224, 1230.
 ———, as shown by the brush, 1449.
 ———, their lateral relation, 1231, 1297, 1304.
 ———, their relation to magnetism, 1411, 1658, 1709.
- Liquefaction*, conduction consequent upon, 380, 394, 410.
- Liquid bodies which are non-conductors*, 405.
- Local chemical affinity*, 947, 959, 961, 1739.
- Machine*, electric, evolution of electricity by, 1748.
 ———, magneto-electric, 135, 154, 158, 1118.
- Magnelectric induction*, 58.
 ———, collectors or conductors, 86.
- Magnesia*, sulphate, decomposed against water, 494, 533.
 ———, transference of, 495.
- Magnet*, a measure of conducting power, 216.
 ——— and current, their relation remembered, 38, note.
 ——— ——— plate revolved together, 218.
 ——— ——— cylinder revolved together, 219.
 ——— revolved alone, 220, 223.
 ——— and moving conductors, their general relation, 256.
 ——— made by induced current, 13, 14.
 ———, electricity from, 36, 220, 223.
- Magnetic bodies*, but few, 255.
 ———, curves, their inductive relation, 217, 232.
 ——— effects of voltaic electricity, 277.

- Magnetic effects of common electricity*, 288, 367.
 ——— magneto-electricity, 27, 83, 345.
 ——— thermo-electricity, 349.
 ——— animal electricity, 354.
 ——— and electrical forces, their relation, 118, 1411, 1653, 1658, 1709, 1731.
 ——— forces active through intermediate particles, 1663, 1710, 1729, 1735.
 ——— *forces of the current*, 1653
 ——— very constant, 1654.
 ——— deflection by common electricity, 289, 296.
 ——— phenomena of Arago explained, 81.
 ——— *induction*. See Induction, magnetic.
 ——— *induction through* quiescent bodies, 1712, 1719, 1720, 1735.
 ——— moving bodies, 1715, 1719.
 ——— and magneto-electric action distinguished, 138, 215, 243, 253.
Magnetism, electricity evolved by, 27.
 ———, its relation to the lines of inductive force, 1411, 1658, 1709.
 ——— bodies classed in relation to, 255.
Magneto-electric currents, their intensity, 183, 193, 211, 213.
 ———, their direction, 114, 116.
 ——— transverse fluids, 33.
 ——— momentary, 30.
 ——— permanent, 89.
 ——— in all conductors, 193, 213.
Magneto-electric induction, 27, 58.
 ———, terrestrial, 140, 181.
 ———, law of, 114.
 ———. See Arago's magnetic phenomena.
Magneto-electric machines, 135, 154, 158.
 ———, inductive effects in their wires, 1118.
Magneto-electricity, its general characters considered, 343, &c.
 ——— identical with other electricities, 360.
 ———, its tension, 343.
 ———, evolution of heat, 344.
 ———, magnetic force, 345.
 ———, chemical force, 346.
 ———, spark, 348.
 ———, physiological effects, 347.
 ———. See Induction, magnetic.
Matter, atoms of, 869, 1703.
 ———, new condition of, 60, 231, 242, 1114, 1661, 1729.
 ———, quantity of electricity in, 852, 861, 873, 1652.
 ———, absolute charge of, 1169.
Measures of electricity, galvanometer, 367, note.
 ———, voltmeter, 704, 736, 739.
 ———, metal precipitated, 740, 842.
 Measure of specific inductive capacity, 1307, 1690.
Measurement of common and voltaic electricities, 361, 860, 1652.
Measurement of electricity, degree, 736, 738.
 ——— by voltmeter, 704, 736, 739.
 ——— by galvanometer, 367, note.
 ——— by metal precipitated, 740, 842.
 Mechanical forces affect chemical affinity, 656.
 Mercurial terminations for convection, 1581.
Mercury, periodide of, an exception to the law of conduction? 691, 1341.
 ———, perchloride of, 692, 1341.
Metallic contact not necessary for electrolyzation, 879.
 ——— not essential to the voltaic current, 879, 887, 915.
 ——— its use in the pile, 893, 896.
 Metallic poles, 557.
 Metal and electrolyte, their state, 946.
Metals, adhesion of fluids to, 1038.
 ———, their power of inducing combination, 564, 608.
 ———, ——— interfered with, 638.
 ———, static induction in, 1329, 1332.
 ———, different, currents induced in, 193, 211.
 ———, generally secondary results of electrolysis, 746.
 ——— transfer chemical force, 918.
 ———, transference of, 539, 545.
 ——— insulate in a certain degree, 1328.
 ———, convective currents in, 1603.
 ———, but few magnetic, 255.
 Model of relation of magnetism and electricity, 116.
 Molecular inductive action, 1164, 1669.
Motion essential to magneto-electric induction, 39, 217, 256.
 ——— across magnetic curves, 217.
 ——— of conductor and magnet, relative, 114.
 ——— not necessary, 218.
 Moving magnet is electric, 220.
Muriatic acid gas, its high insulating power, 1395.
 ———, brush in, 1462.
 ———, dark discharge in, 1554.
 ———, glow in, 1534.
 ———, positive and negative brush in, 1476.
 ———, spark in, 1422, 1463.
 ———, ———, has no dark interval, 1463, 1555.
Muriatic acid decomposed by common electricity, 314.
 ———, its electrolysis, (primary), 758, 786.
 Nascent state, its relation to combination, 658, 717.
Natural standard of direction for current, 663.
 ——— relation of electrolytic intensity, 987½.
Nature of the electric current, 1617.

- Nature of the electric force or forces*, 1667.
Negative current, none, 1627, 1632.
 — *discharge*, 1465, 1484.
 — —, as spark, 1467, 1482.
 — —, as brush, 1466, 1502.
 — spark or brush, 1484, 1502.
 — *and positive discharge*, 1465, 1482, 1525.
 — in different gases, 1393.
New electrical condition of matter, 60, 231, 242, 1114, 1661, 1729.
 — law of conduction, 380, 394, 410.
Nitric acid formed by spark in air, 324.
 — *favours* excitation of current, 906, 1138.
 — — transmission of current, 1020.
 — is best for excitation of battery, 1137.
 —, nature of its electrolysis, 752.
Nitrogen determined to either pole, 554, 748, 752.
 — a secondary result of electrolysis, 746, 748.
 —, brush in, 1458.
 —, dark discharge in, 1559.
 —, glow in, 1534.
 —, spark in, 1422, 1463.
 —, *positive and negative* brush in, 1476.
 —, — discharge in, 1512.
 —, its influence on lightning, 1464.
Nomenclature, 662, 1483.
Nonconduction by solid electrolytes, 381, 1358, 1705.
Note on electrical excitation, 1737.
Nuclei, their action, 623, 657.
- Olefiant gas, interference of, 640, 652.
Ordinary electricity, its tension, 285.
 — evolution of heat, 287.
 — magnetic force, 288, 362.
 — *chemical force*, 309, 454.
 — —, precautions, 322.
 — spark, 333.
 — physiological effect, 332.
 — general characters considered, 284.
 —, identity with other electricities, 360.
Origin of the force of the voltaic pile, 878, 916, 919.
Oxidation the origin of the electric current, in the voltaic pile, 919, 930.
Oxide of lead electrolysed, 797.
Oxygen, brush in, 1457.
 —, *positive and negative* brush in, 1476.
 —, — discharge in, 1513.
 —, solubility of, in cases of electrolyzation, 717, 728.
 —, spark in, 1422.
 — *and hydrogen combined by platina plates*, 570, 605, 630.
 — — spongy platina, 609, 636.
 — — other metals, 608.
- Particles*, their nascent state, 658.
 — in air, how charged, 1564.
 —, neighbouring, their relation to each other, 619, 624, 657.
 —, contiguous, active in induction, 1165, 1677.
 — of a dielectric, their inductive condition, 1369, 1410, 1669.
 —, polarity of, when under induction, 1298, 1676.
 —, *how polarised*, 1669, 1679.
 —, —, in any direction, 1689.
 —, —, as wholes or elements, 1699.
 —, —, in electrolytes, 1702.
 —, crystalline, 1689.
 —, contiguous, active in electrolysis, 1349, 1702.
 —, *their* action in electrolyzation, 520, 1343, 1703.
 —, — local chemical action, 961, 1739.
 —, — relation to electric action, 73.
 —, — electric action, 1669, 1679, 1740.
Path of the electric spark, 1407.
Phosphoric acid not an electrolyte, 682.
Physiological effects of voltaic electricity, 279.
 — common electricity, 332.
 — magneto-electricity, 56, 347.
 — thermo-electricity, 349.
 — animal electricity, 357.
Pile, voltaic, electricity of, 875.
 —. See Battery, voltaic.
- Plates of platina* effect combination, 568, 571, 590, 630.
 — *prepared by* electricity, 570, 585, 588,
 — — friction, 591.
 — — heat, 595.
 — — chemical cleansing, 599, 605.
 —, clean, their general properties, 633, 717.
 —, *their power preserved*, 576.
 —, — in water, 580.
 —, *their power diminished by* action, 581.
 —, — exposure to air, 636.
 —, *their power affected by* washing in water, 582.
 —, — heat, 584, 597.
 —, — presence of certain gases, 638, 655.
 —, their power, cause of, 590, 616, 630.
 —, *theory of their action*, Döbereiner's, 610.
 —, —, Dulong and Thenard's, 611.
 —, —, Fusinieri's, 613.
 —, —, author's, 619, 626, 630, 656.
Plates of voltaic battery foul, 1145.
 —, new and old, 1146.
 —, vicinity of, 1148.

- Plates of voltaic battery*, immersion of, 1003, 1150.
 —, number of, 989, 1151.
 —, large or small, 1154.
Platina, clean, its characters, 633, 717.
 — attracts matter from the air, 634.
 —, spongy, its state, 637.
 —, clean, its power of effecting combination, 564, 590, 605, 617, 630.
 —, — interfered with, 638.
 —, its action retarded by olefiant gas, 640, 652.
 —, —, carbonic oxide, 645, 652.
 —. See Combination, Plates of platina, and Interference.
 — poles, recombination effected by, 567, 588.
 Plumbago poles for chlorides, 794.
 Poisson's theory of electric induction, 1305.
Points, favour convective discharge, 1573.
 —, fluid for convection, 1581.
Polar forces, their character, 1665.
 — decomposition by common electricity, 312, 321, 469.
Polarity, meaning intended, 1304, 1685.
 — of particles under induction, 1298, 1676.
 —, electric, 1670, 1685.
 —, —, its direction, 1688, 1703.
 —, —, its variation, 1687.
 —, —, its degree, 1686.
 —, —, in crystals, 1689.
 —, —, in molecules or atoms, 1699.
 —, —, in electrolytes, 1702.
 Polarized light across electrolytes, 951.
Poles, electric, their nature, 461, 498, 556, 662.
 —, appearance of evolved bodies at, accounted for, 535.
 —, one element to either? 552, 681, 757.
 —, of air, 455, 461, 559.
 —, of water, 494, 558.
 —, of metal, 557.
 — of platina, recombination effected by, 567, 588.
 — of plumbago, 794.
 Poles, magnetic, distinguished, 44, note.
 Porrett's peculiar effects, 1646.
Positive current none, 1627, 1632.
 — discharge, 1465, 1480.
 — —, as spark, 1467, 1482.
 — —, as brush, 1467, 1476.
 — spark or brush, 1484, 1502.
 — and negative, convective discharge, 1600.
 — — disruptive discharge, 1465, 1482, 1485, 1525.
 — — — in different gases, 1393.
 — — — voltaic discharge, 1524.
 — — — electrolytic discharge, 1525.
 Potassa, acetate, nature of its electrolysis, 749.
 Potassium, iodide of, electrolysed, 805.
 Power of voltaic batteries estimated, 1126.
 Powers, their state of tension in the pile, 949.
 Practical results with the voltaic battery, 1136.
 Pressure of air retains electricity, explained, 1377, 1398.
 Primary electrolytical results, 742.
 Principles, general, of definite electrolytic action, 822.
 Proportionals in electrolytes, single, 679, 697.
Quantity of electricity in matter, 852, 861, 873, 1652.
 — voltaic battery, 990.
 Rarefaction of air facilitates discharge, why, 1375.
 Recombination, spontaneous, of gases from water, 566.
Relation, by measure, of electricities, 361.
 — of magnets and moving conductors, 256.
 — of magnetic induction to intervening bodies, 1662, 1728.
 — of a current and magnet, to remember, 38, note.
 — of electric and magnetic forces, 118, 1411, 1653, 1658, 1709, 1731.
 — of conductors and insulators, 1321, 1326, 1334, 1338.
 — of conduction and induction, 1320, 1337.
 — of induction and disruptive discharge, 1362.
 — — electrolyzation, 1164, 1343.
 — — excitation, 1178, 1740.
 — — charge, 1171, 1177, 1300.
 — of insulation and induction, 1324, 1362, 1368, 1678.
 —, lateral, of lines of inductive force, 1231, 1297, 1304.
 — of a vacuum to electricity, 1613.
 — of spark, brush, and glow, 1533, 1539, 1542.
 — of gases to positive and negative discharge, 1510.
 — of neighbouring particles to each other, 619, 624.
 — of elements in decomposing electrolytes, 923, 1702.
 — — exciting electrolytes, 921.
 — of acids and bases voltaically, 927, 933.
 Remarks on the active battery, 1034, 1136.
 Residual charge of a Leyden jar, 1249.
Resistance to electrolysis, 891, 904, 911, 1007.
 — of an electrolyte to decomposition, 1007.

- Results of electrolysis, primary or secondary*, 742, 777.
 —, practical, with the voltaic battery, 1136.
 —, general, as to induction, 1295, 1669.
 Retention of electricity by pressure of the atmosphere explained, 1377, 1398.
Revolving plate. See Arago's phenomena.
 — *globe, Barlow's*, effect explained, 137, 160, 169.
 — —, magnetic, 164.
 — —, direction of currents in, 161, 166.
 Riffault's and Chompré's theory of electrochemical decomposition, 485, 507, 512.
 Rock crystal, induction across, 1692.
 Room, insulated and electrified, 1173.
 Rotation of the earth a cause of magneto-electric induction, 181.

 Salts considered as electrolytes, 698.
 Scale of electrolytic intensities, 912.
Secondary electrolytical results, 702, 742, 748, 777.
 — become measures of the electric current, 843.
Sections of the current, 498, 1634.
 —, decomposing force alike in all, 501, 1621.
Sections of lines of inductive action, 1369.
 —, amount of force constant, 1369.
 Shock, strong, with one voltaic pair, 1049.
Silver, chloride of, its electrolyzation, 541, 813, 902.
 —, electrolytic intensity for, 979.
 Silver, sulphuret of, hot, conducts well, 433.
Simple voltaic circles, 875.
 —, decomposition effected by, 897, 904, 931.
 Single and many pairs of plates, relation of, 990.
Single voltaic circuits, 875.
 — without metallic contact, 879.
 — with metallic contact, 893.
 — their force exalted, 906.
 — give strong shocks, 1049.
 — a bright spark, 1050.
Solid electrolytes are non-conductors, 394, 402, 1358.
 —, why, 910, 1705.
Solids, their power of inducing combination, 564, 618.
 — interfered with, 638.
 Solubility of gases in cases of electrolyzation, 717, 728.
Source of electricity in the voltaic pile, 875.
 — is chemical action, 879, 916, 919, 1741.
 Spark, 1360, 1406.
Spark, electric, its conditions, 1360, 1406, 1553.
 — path, 1407.
Spark, electric, its light, 1553.
 — insensible duration or time, 1438.
 — accompanying dark parts, 1547, 1632.
 — determination, 1370, 1409.
 — is affected by the dielectrics, 1395, 1421.
 — size of conductor, 1372.
 — form of conductor, 1302, 1374.
 — rarefaction of air, 1375.
 —, atmospheric or lightning, 1464, 1641.
 —, negative, 1393, 1467, 1482, 1484, 1502.
 —, positive, 1393, 1448, 1467, 1482, 1484, 1502.
 —, ragged, 1420, 1448.
 —, when not straight, why, 1568.
 —, variation in its length, 1381.
 —, tendency to its repetition, 1392.
 —, facilitates discharge, 1417, 1553.
 —, passes into brush, 1448.
 —, preceded by induction, 1362.
 —, forms nitric acid in air, 324.
 —, in gases, 1388, 1421.
 —, in air, 1422.
 —, in nitrogen, 1422, 1463.
 —, in oxygen, 1422.
 —, in hydrogen, 1422.
 —, in carbonic acid, 1422, 1463.
 —, in muriatic acid gas, 1422, 1463.
 —, in coal-gas, 1422.
 —, in liquids, 1424.
 —, precautions, 958, 1074.
 —, voltaic, without metallic contact, 915, 956.
 — from single voltaic pair, 1050.
 — from common and voltaic electricity assimilated, 334.
 —, first magneto-electric, 32.
 — of voltaic electricity, 280.
 — of common electricity, 333.
 — of magneto-electricity, 348.
 — of thermo-electricity, 349.
 — of animal electricity, 358.
 —, brush and glow related, 1533, 1539, 1542.
 Sparks, their expected coalition, 1412.
 Specific induction. *See Induction, specific*, 1252.
Specific inductive capacity, 1252.
 —, apparatus for, 1187.
 — of lac, 1256, 1270, 1308.
 — of sulphur, 1275, 1310.
 — of air, 1284.
 — of gases, 1283, 1290.
 — of glass, 1271.
Spermaceti, its conducting power, 1240, 1323.
 —, its relation to conduction and insulation, 1322.
 Standard of direction in the current, 663.
 State, electrotonic, 60, 231, 242, 1114, 1661, 1729.
 Static induction. *See Induction, static.*

- Sturgeon, his form of Arago's experiment, 249.
 —, use of amalgamated zinc by, 863, 999.
Sulphate of soda decomposed by common electricity, 317.
 —, electrolytic intensity for, 975.
Sulphur determined to either pole, 552, 681, 757.
 —, its conducting power, 1241, 1245.
 —, its specific inductive capacity, 1275.
 —, copper and iron, circle, 943.
Sulphuret of carbon, interference of, 650.
 — silver, hot, conducts well, 433.
Sulphuretted solution excites the pile, 943.
Sulphuric acid, conduction by, 409, 681.
 —, magneto-electric induction on, 200, 213.
 — in voltaic pile, its use, 925.
 — not an electrolyte, 681.
 —, its transference, 525.
 —, its decomposition, 681, 757.
Sulphurous acid, its decomposition, 755.
Summary of conditions of conduction, 443.
 — molecular inductive theory, 1669.
- Table of discharge in gases*, 1388.
 — electric effects, 360.
 — electro-chemical equivalents, 847.
 — electrolytes affected by fusion, 402.
 — insulation in gases, 1388.
 — ions, anions, and cations, 847.
Tartaric acid, nature of its electrolysis, 775.
Tension, inductive, how represented, 1370.
 — of voltaic electricity, 268.
 — of common electricity, 285.
 — of thermo-electricity, 349.
 — of magneto-electricity, 343.
 — of animal electricity, 352.
 — of zinc and electrolyte in the voltaic pile, 949.
Terrestrial electric currents, 187.
Terrestrial magneto-electric induction, 140.
 — cause of aurora borealis, 192.
 —, *electric currents produced by*, 141, 150.
 —, —, *in helices* alone, 148.
 —, —, — with iron, 141, 146.
 —, —, — with a magnet, 147.
 —, —, — a single wire, 170.
 —, —, — a revolving plate, 149.
 —, —, — a revolving ball, 160.
 —, —, — the earth, 173.
 Test between magnetic and magneto-electric action, 215, 243.
Theory of combination of gases by clean platina, 619, 626, 630, 656.
 — electro-chemical decomposition, 477, 661, 1623, 1704.
 — the voltaic apparatus, 875, 1741.
 — static induction, 1165, 1231, 1295, 1666, 1667.
- Theory of disruptive discharge*, 1368, 1406, 1434.
 — Arago's phenomena, 120.
Thermo-electricity, its general characters, 349.
 — identical with other electricities, 360.
 —, its evolution of heat, 349.
 —, magnetic force, 349.
 —, physiological effects, 349.
 —, spark, 349.
Time, 59, 68, 124, 1248, 1328, 1346, 1418, 1431, 1436, 1498, 1612, 1641, 1730.
Tin, iodide of, electrolyzed, 804.
 —, protochloride, electrolysis of, definite, 789, 819.
Torpedo, nature of its electric discharge, 359.
 —, its enormous amount of electric force, 359.
 Transfer of elements and the current, their relation, 923, 962.
Transference is simultaneous in opposite directions, 542, 828.
 —, uncombined bodies do not travel, 544, 546, 826.
 — of elements, 454, 507, 539, 550, 826.
 — — across great intervals, 455, 468.
 — —, its nature, 519, 525, 538, 549.
 — of chemical force, 918.
 Transverse forces of the current, 1653, 1709.
 Travelling of charged particles, 1563.
 Trough, voltaic. *See* Battery, voltaic.
Turpentine, oil of, a good fluid insulator, 1172.
 —, its insulating power destroyed, 1571.
 —, charged, 1172.
 —, brush in, 1452.
 —, electric motions in, 1588, 1595.
 —, convective currents in, 1595, 1598.
- Unipolarity, 1635.
- Vacuum, its relation to electricity, 1613.
 Vaporization, 657.
Velocity of conduction in metals varied, 1333.
 — the electric discharge, 1641, 1649.
 — conductive and electrolytic discharge, difference of, 1650.
 Vicinity of plates in voltaic battery, 1148.
 Volta-electric induction, 26.
Volta-electrometer, 704, 736.
 —, fluid decomposed in it, water, 706, 728, 732.
 —, forms of, 707, 734.
 — tested for variation of electrodes, 714, 722.
 — — fluid within, 727.
 — — intensity, 723.
 —, strength of acid used in, 728, 733.
 —, its indications by oxygen and hydrogen, 736.

- Volta-electrometer*, its indications by hydrogen, 734.
 —, — oxygen, 735.
 —, how used, 737.
 Voltmeter, 704.
Voltaic battery, its nature, 875, 989.
 —, remarks on, 1034, 1136.
 — improved, 1001, 1119.
 —, practical results with, 1136.
 —. See Battery, voltaic.
Voltaic circles, simple, 875.
 —, decomposition by, 897.
 Voltaic circles associated, or battery, 989.
Voltaic circuit, relation of bodies in, 962.
 —, defined, 282, 511.
 —, origin of, 916, 1741.
 —, its direction, 663, 925.
 —, intensity increased, 905, 990.
 —, produced by oxidation of zinc, 919, 930.
 — not due to combination of oxide and acid, 925, 933.
 —, its relation to the combining oxygen, 921, 962.
 —, — combining sulphur, 943.
 —, — the transferred elements, 923, 962.
 —, relation of bodies in, 962.
 Voltaic current, 1617. See Current, electric.
 Voltaic discharge, positive and negative, 1524.
 Voltaic decomposition, 450, 660. See Decomposition, electro-chemical.
Voltaic electricity, identical with electricity, otherwise evolved, 268, 360.
 —, discharged by points, 272.
 —, — hot air, 271, 274.
 —, its tension, 268, 275.
 —, evolution of heat by, 276.
 —, its magnetic force, 277.
 —, its chemical force, 278.
 —, its spark, 280.
 —, its physiological effects, 279.
 —, its general characters considered, 268.
Voltaic pile distinguished, 856, note.
 —, electricity of, 875.
 —, depends on chemical action, 872.
 —, relation of acid and bases in the, 927.
 —. See Battery, voltaic.
Voltaic spark without contact, 915, 956.
 —, precautions 8, 1074.
 Voltaic trough, 989. See Battery, voltaic.
Water, flowing, electric currents in, 190.
 —, retardation of current by, 1159.
 —, its direct conducting power, 1017, 1159, 1355.
 —, — constant, 984.
 —, electro-chemical decomposition against, 494, 532.
 —, poles of, 494, 533, 558.
 —, its influence in electro-chemical decomposition, 472.
 —, is the great electrolyte, 924.
 —, the exciting electrolyte when pure, 944.
 —, — acidulated, 880, 926, 1137.
 —, — alkalinized, 931, 934, 941.
 —, electrolytic intensity for, 968, 981, 1017.
 — electrolyzed in a single circuit, 862.
 —, its electrolysis definite, 732, 785, 807.
 —, decomposition of by fine wires, 327.
 —, quantity of electricity in its elements, 853, 861.
 —, determined to either pole, 553.
Wheatstone's analysis of the electric brush, 1427.
 — measurement of conductive velocity in metals, 1328.
Wire, ignition of, by the electric current, 853, note, 1631.
 — is uniform throughout, 1630.
Wire a regulator of the electric current, 853, note.
 —, velocity of conduction in, varied, 1333.
 —, single, a current induced in, 170.
 —, long, inductive effects in, 1064, 1118.
Wollaston on decomposition by common electricity, 309.
 — decomposition of water by points, 327.
Zinc, amalgamated, its condition, 863, 1000.
 —, used in pile, 999.
 —, how amalgamated, 863.
 —, of troughs, its purity, 1144.
 —, its relation to the electrolyte, 949.
 —, its oxidation is the source of power in the pile, 919.
 — plates of troughs, foul, 1145.
 — —, new and old, 1146.
 —, waste of, in voltaic batteries, 997.

THE END.

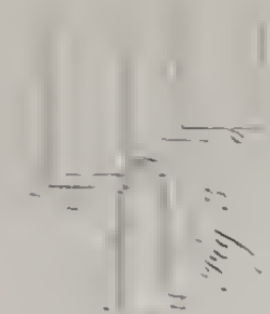

Fig. 3.



Fig. 4.

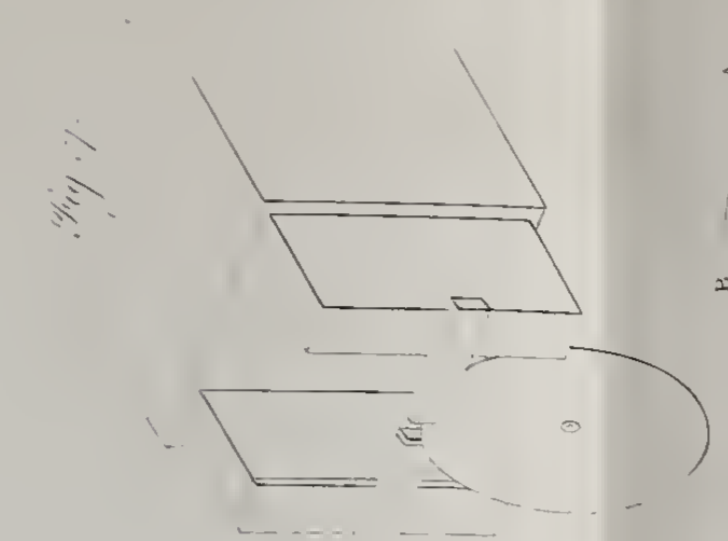

Fig. 7.

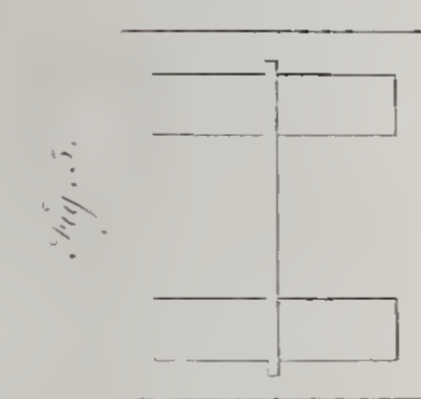

Fig. 5.

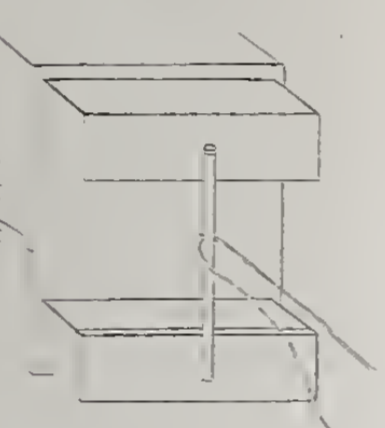

Fig. 6.



Fig. 8.

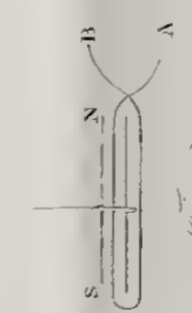

Fig. 8.

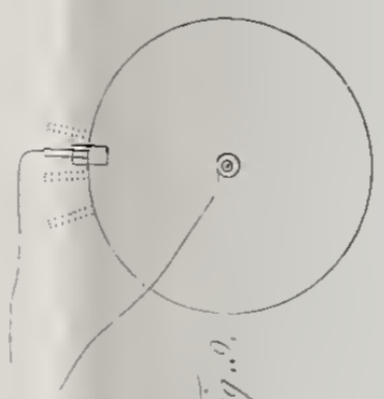

Fig. 9.

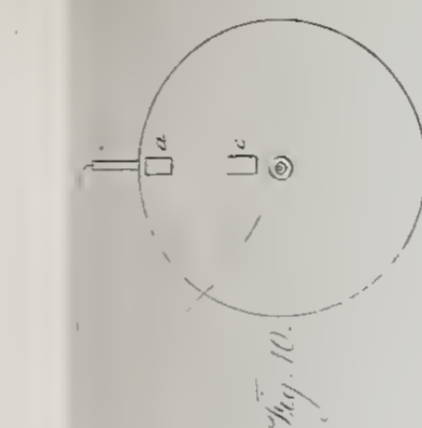

Fig. 10.

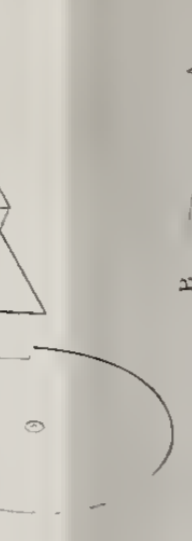

Fig. 11.



Fig. 12.

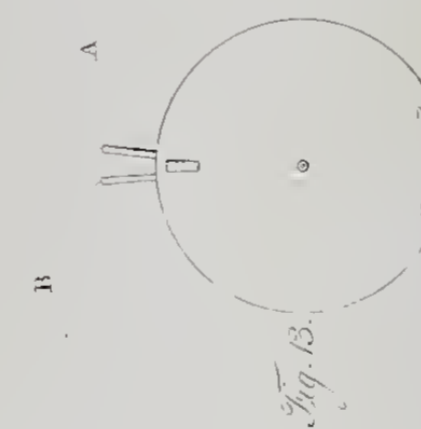

Fig. 13.

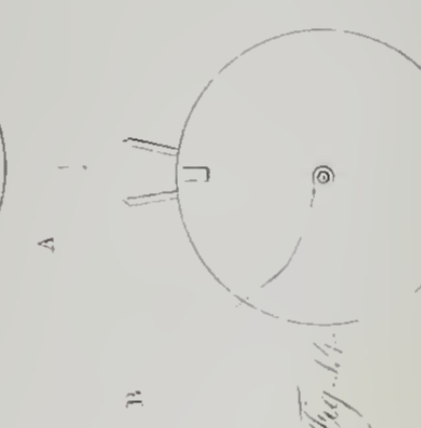

Fig. 14.

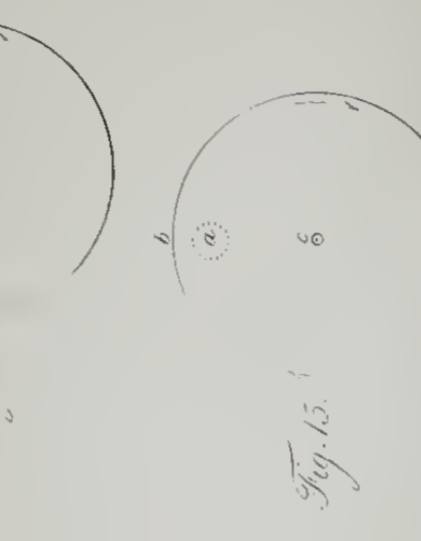

Fig. 15.

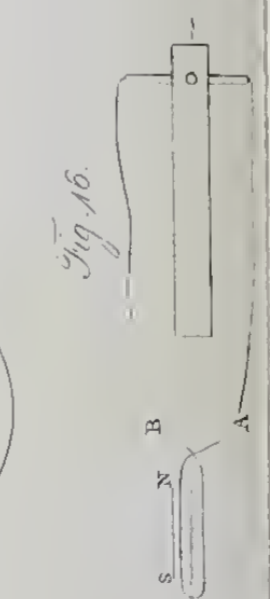

Fig. 16.

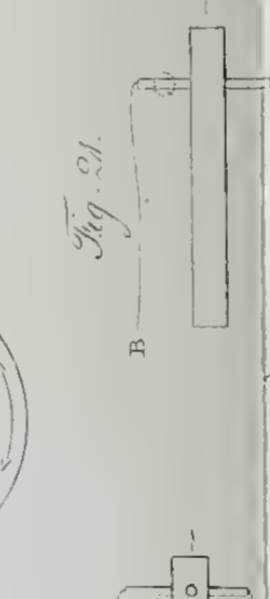

Fig. 21.

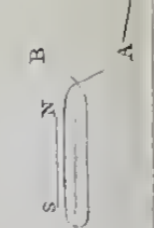

Fig. 18.

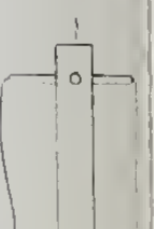

Fig. 19.



Fig. 22.



Fig. 23.



Fig. 27.

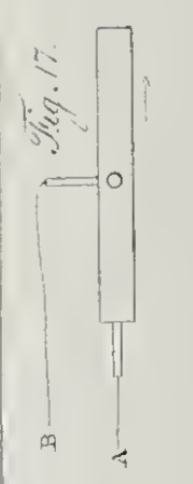

Fig. 17.

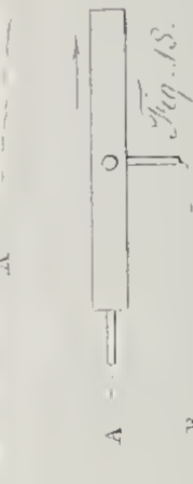

Fig. 24.

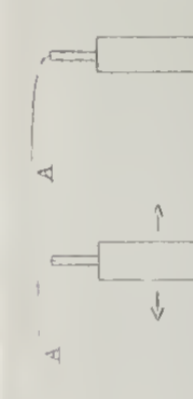

Fig. 25.



Fig. 28.

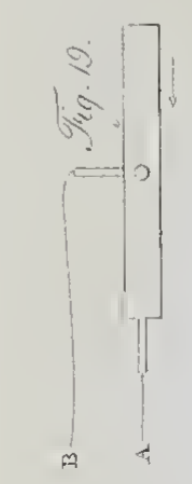

Fig. 20.



Fig. 26.

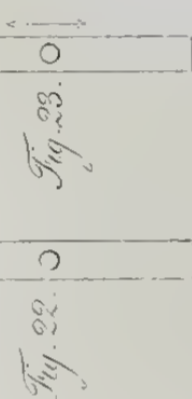

Fig. 29.

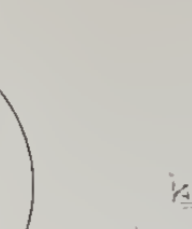

Fig. 30.

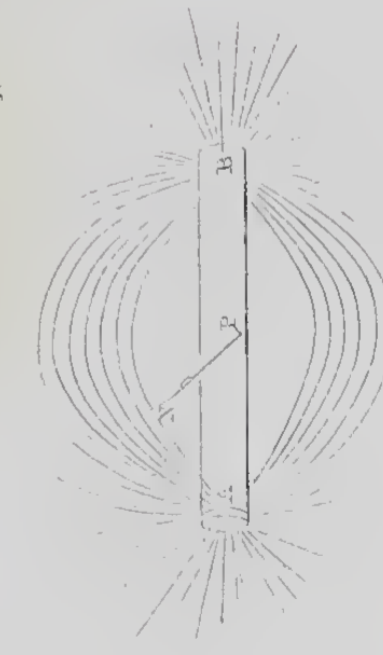

Fig. 25.

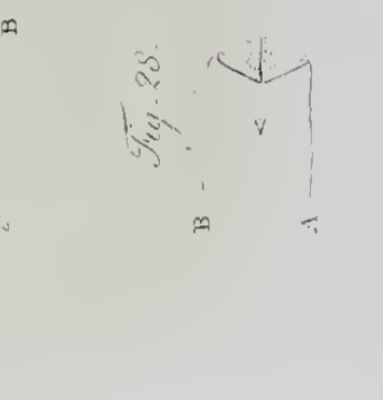

Fig. 28.

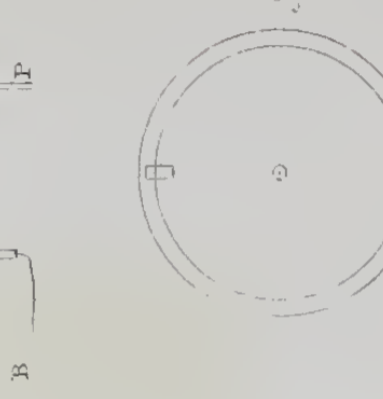

Fig. 29.

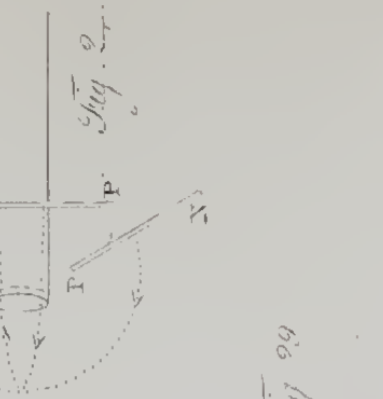

Fig. 30.

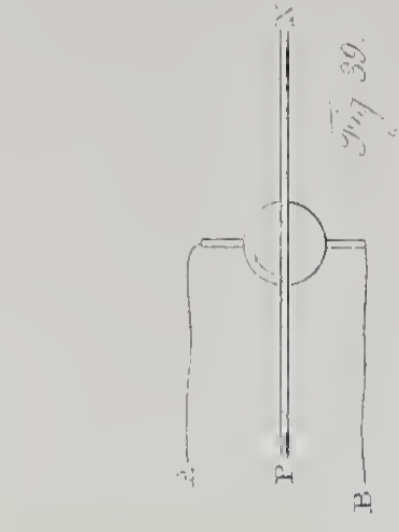
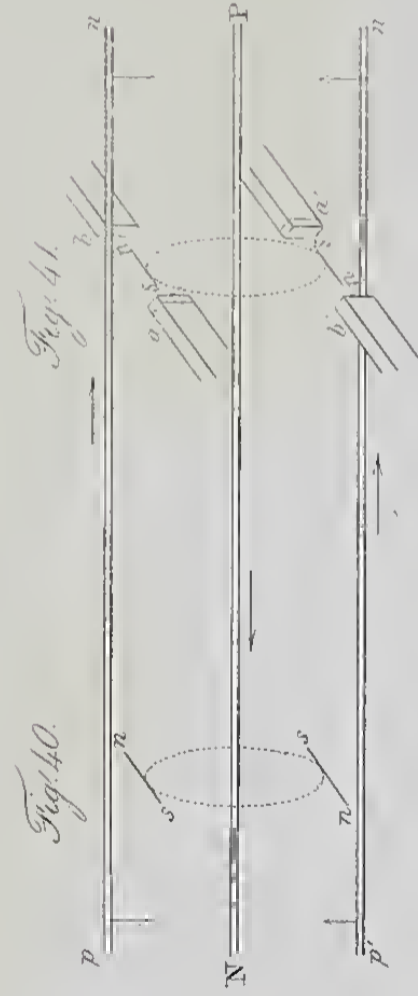
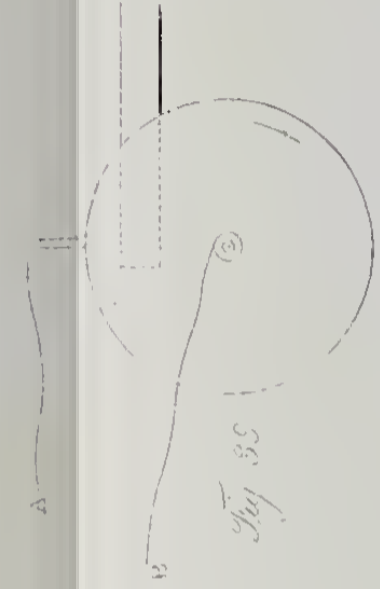
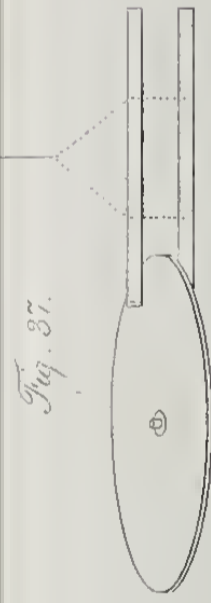
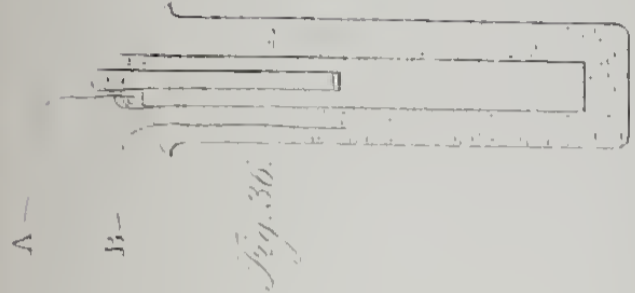
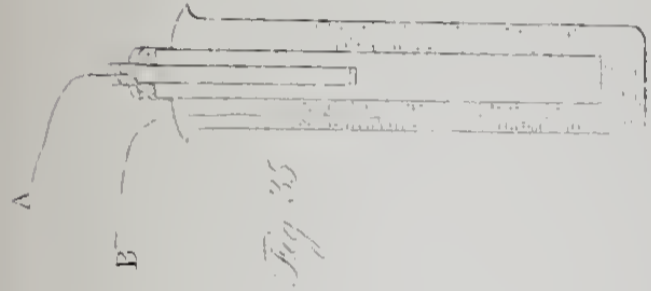
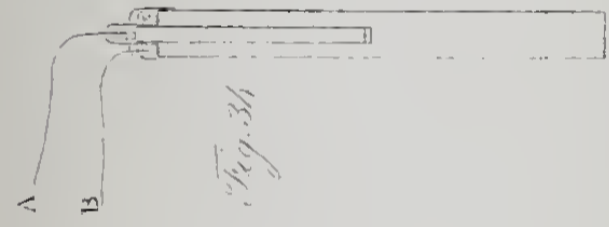
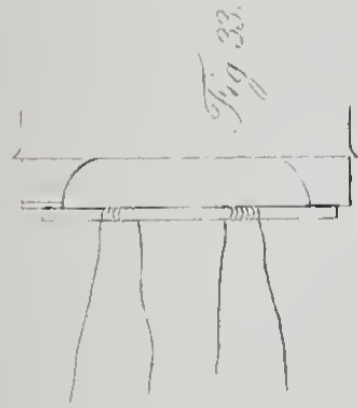



Fig. 45

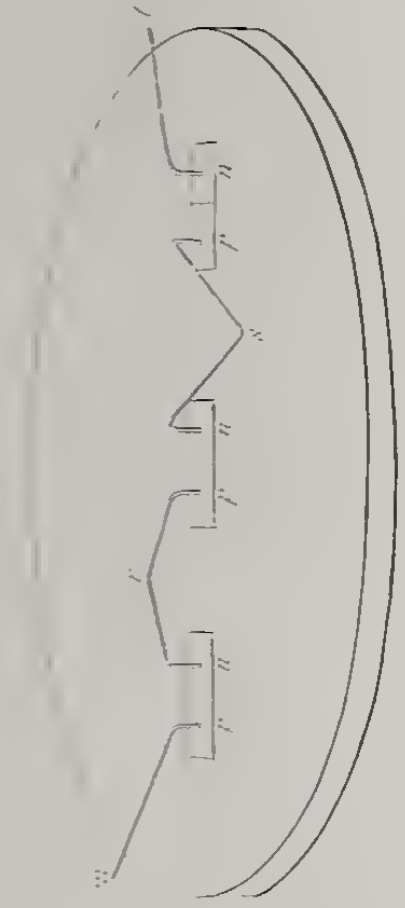
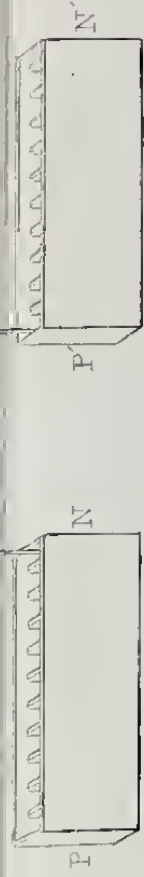
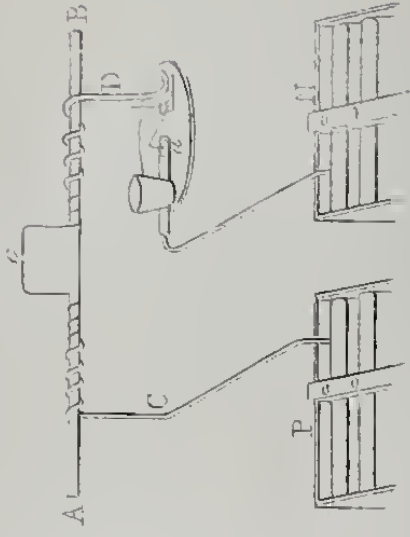
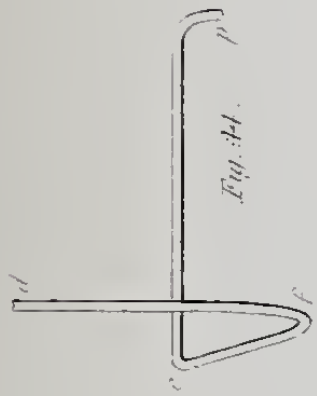

Fig. 43



of design.

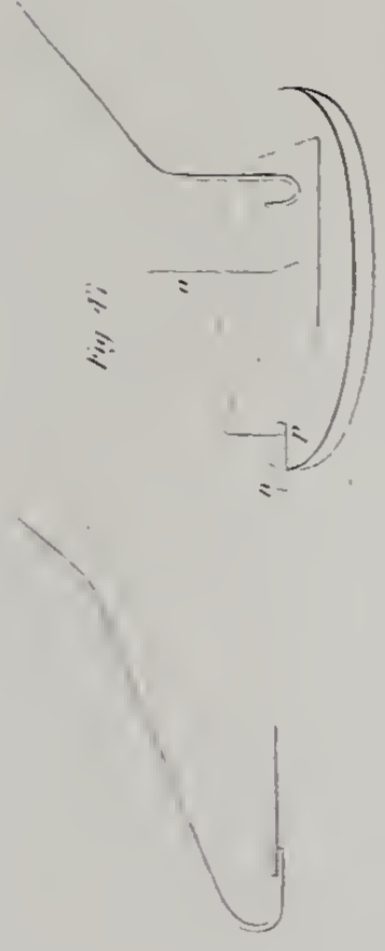

Fig. 47.

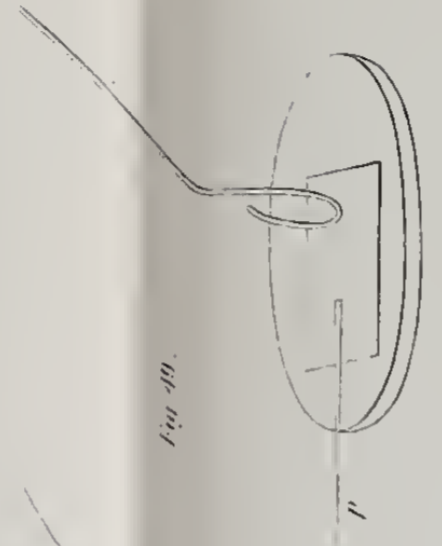

Fig. 49.



Fig. 48.

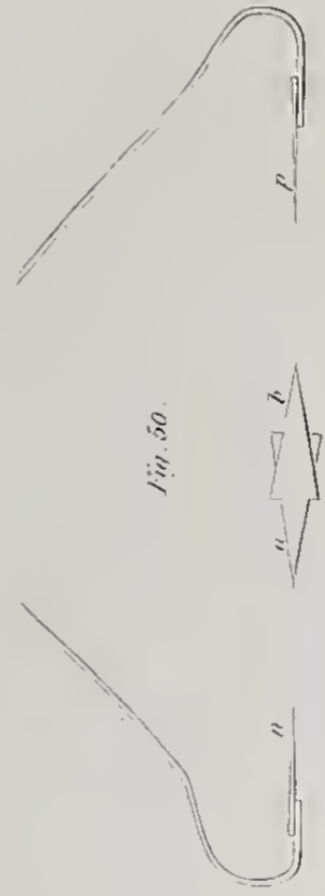

Fig. 50.

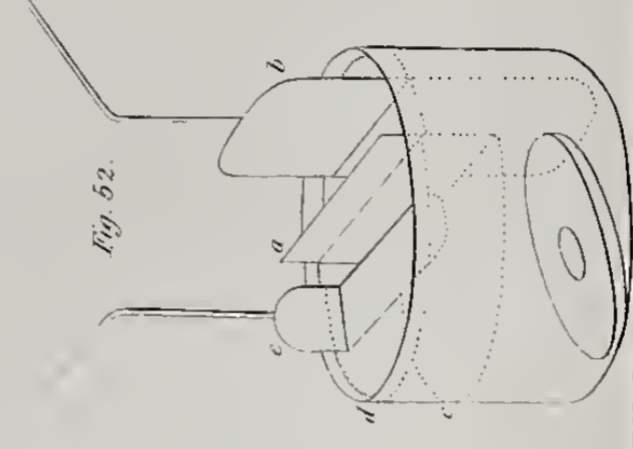

Fig. 52.

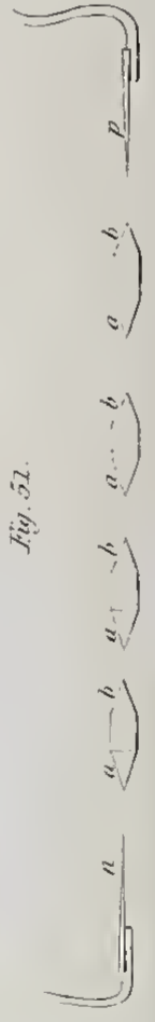

Fig. 53.

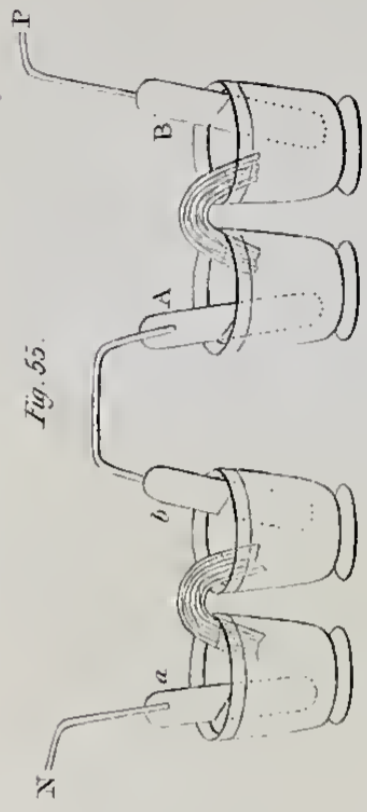

Fig. 55.

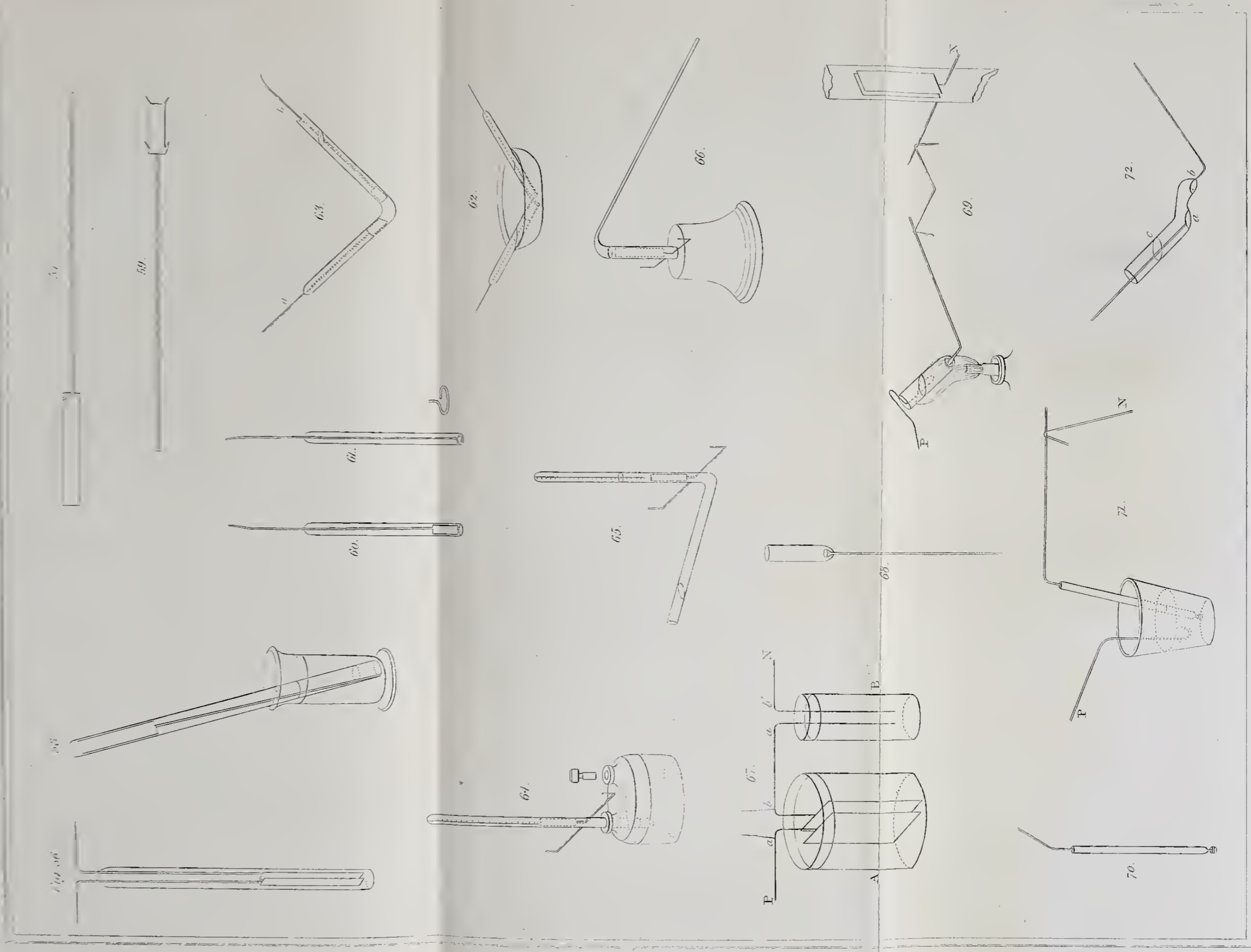

Fig. 53.



Fig. 54.







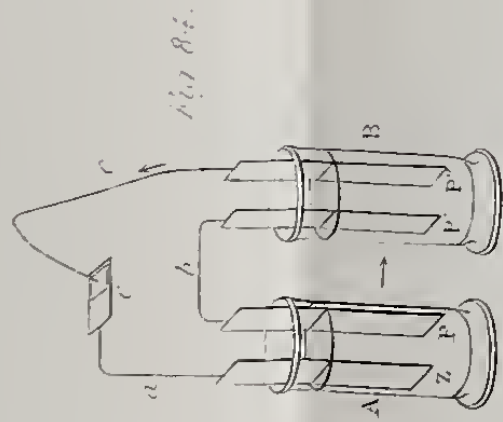
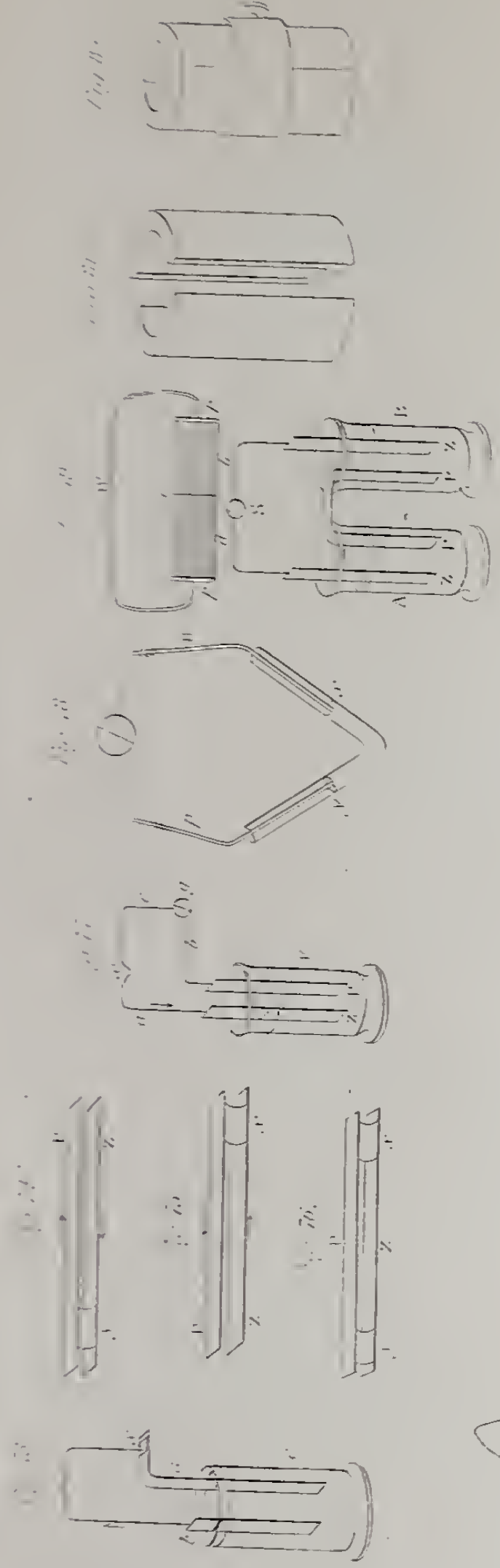

Fig. 87.

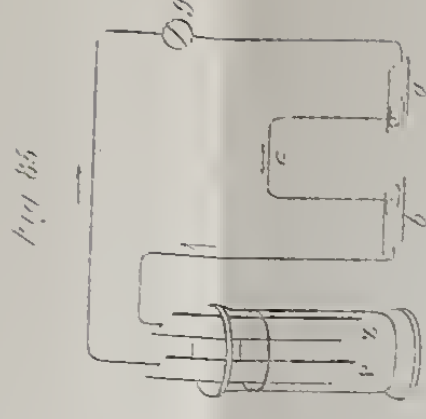
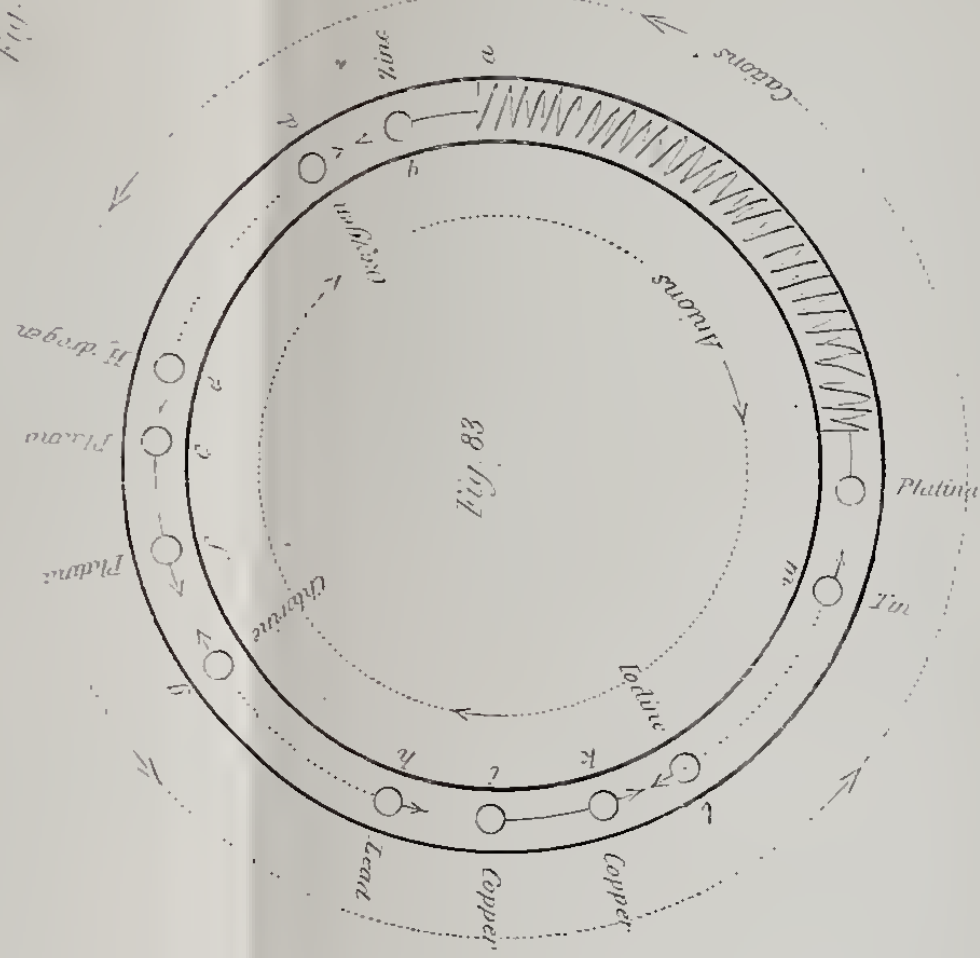
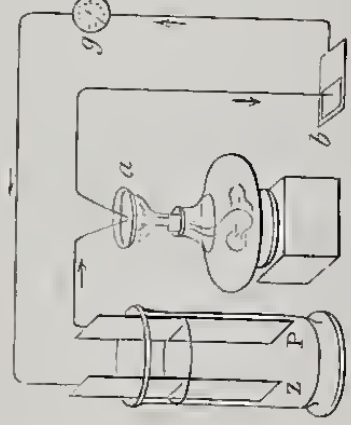

Fig. 86.

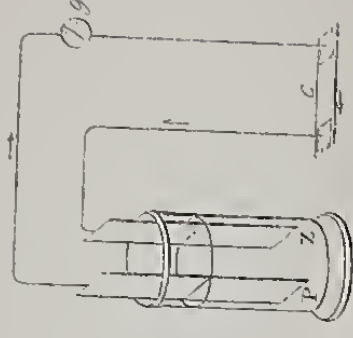

Fig. 89.

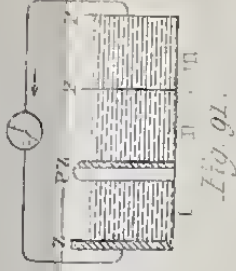
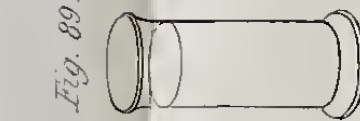

Fig. 91.

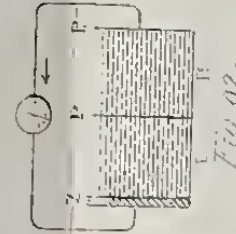

Fig. 92.

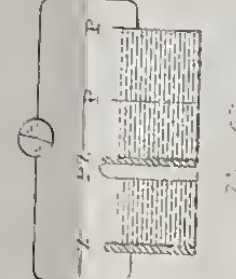

Fig. 93.

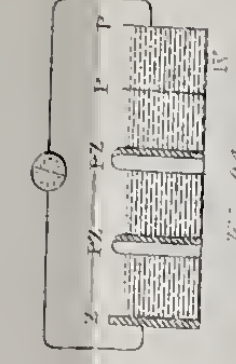

Fig. 94.

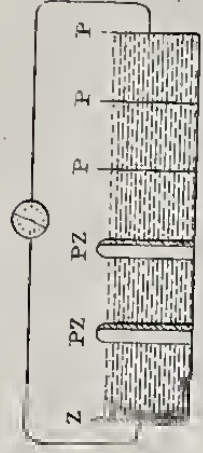

Fig. 95.

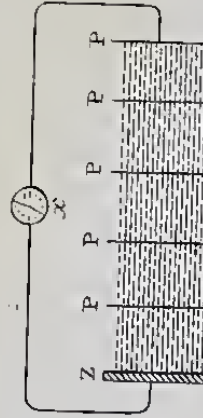

Fig. 98.

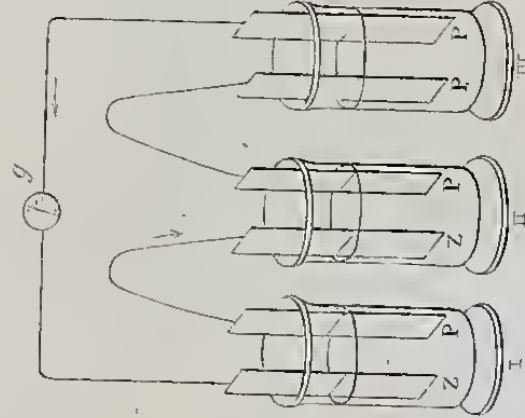

Fig. 99.

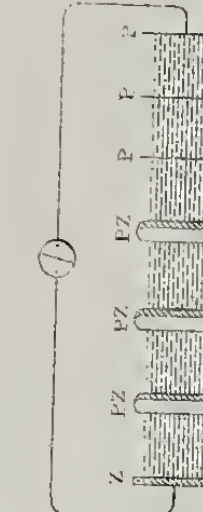

Fig. 96.

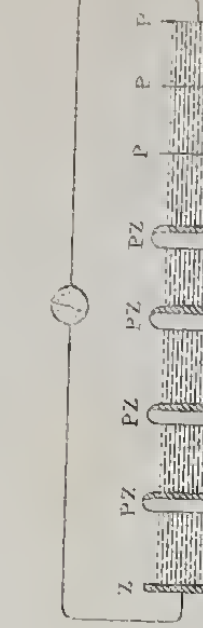

Fig. 97.

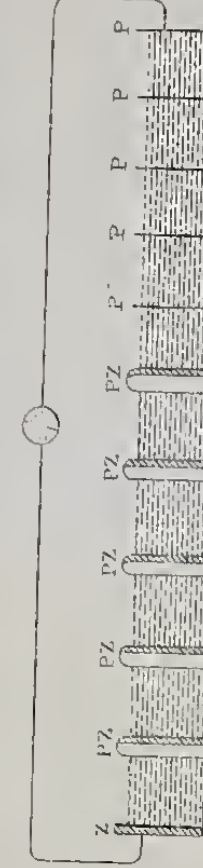

Fig. 99.

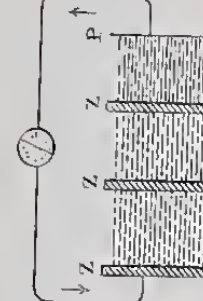

Fig. 101.

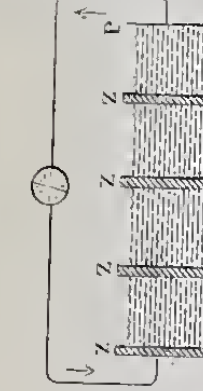

Fig. 102.

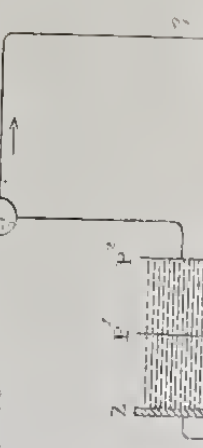
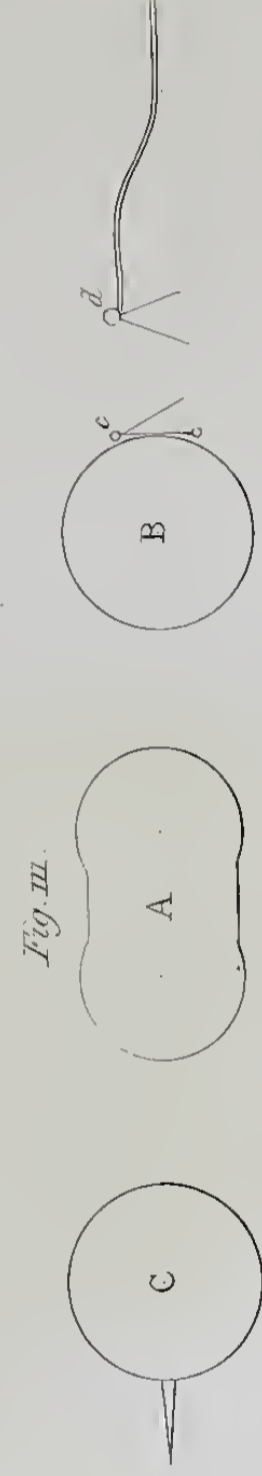
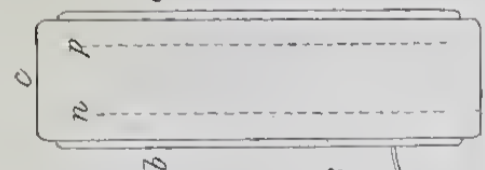
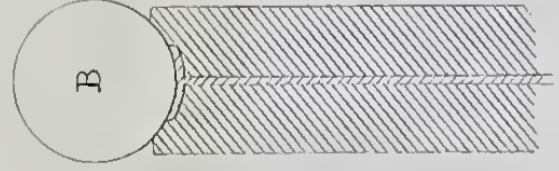
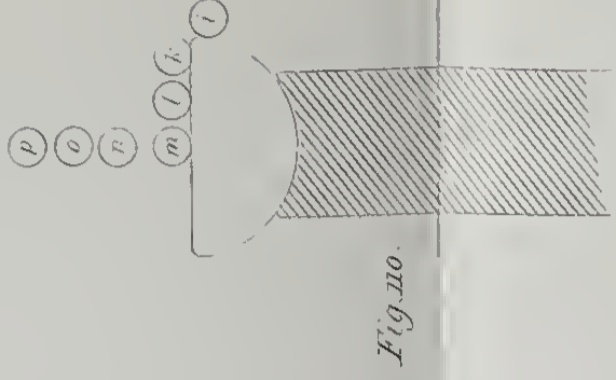
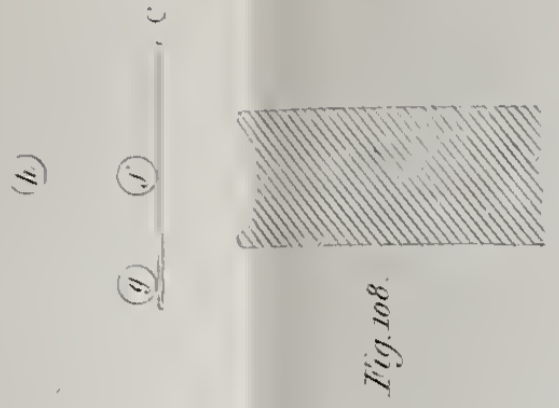
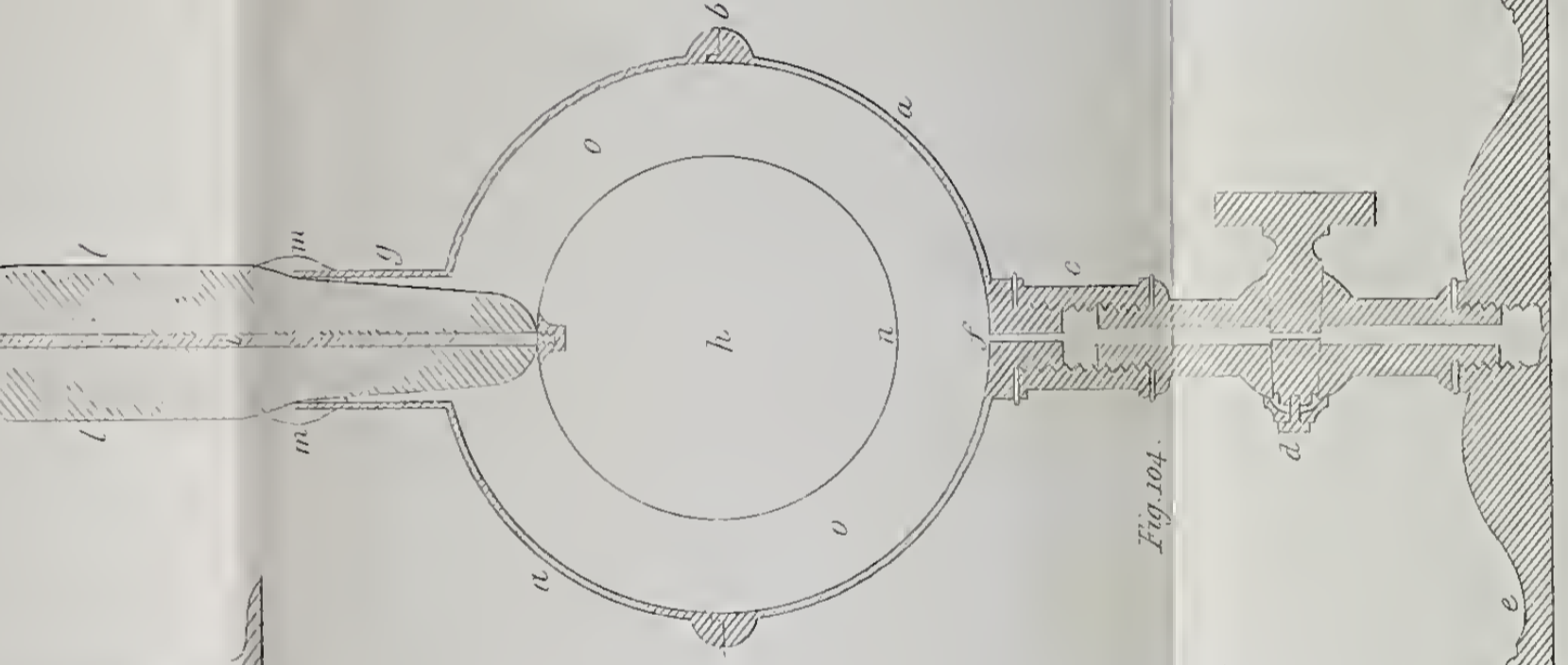
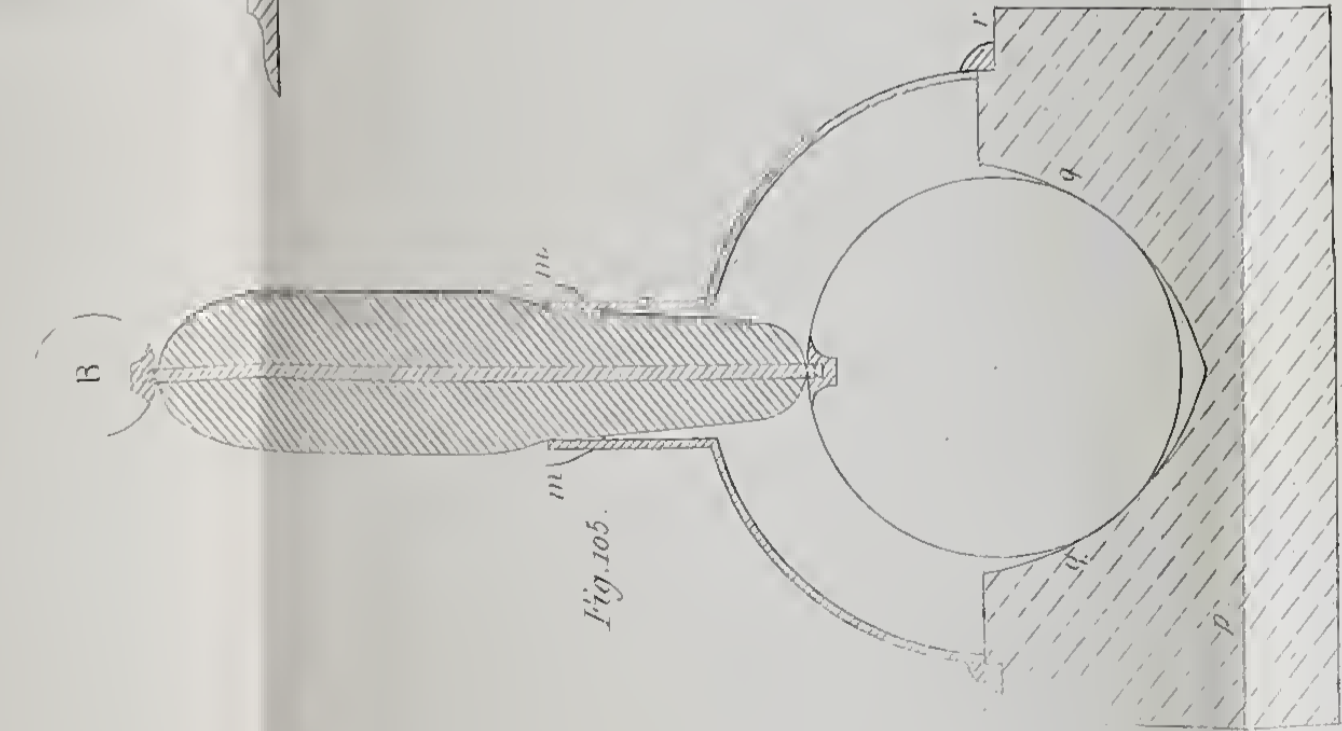
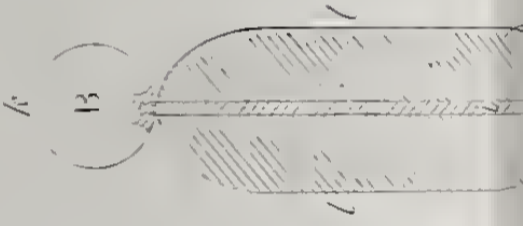
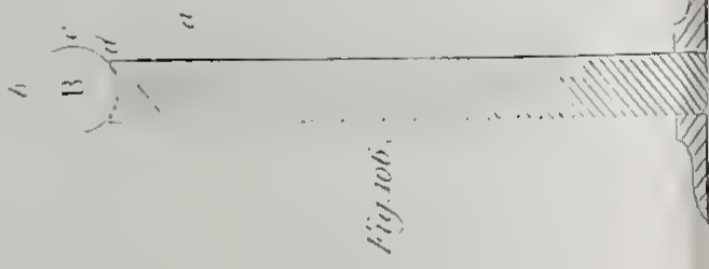
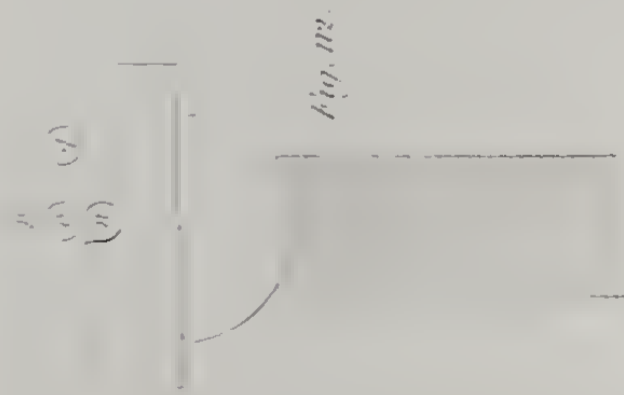
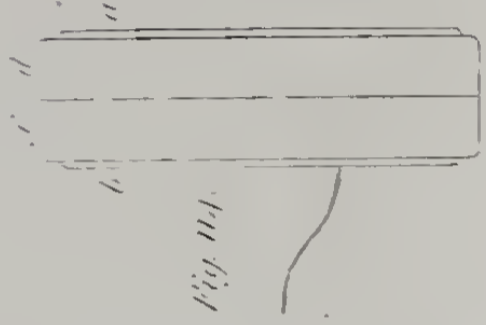
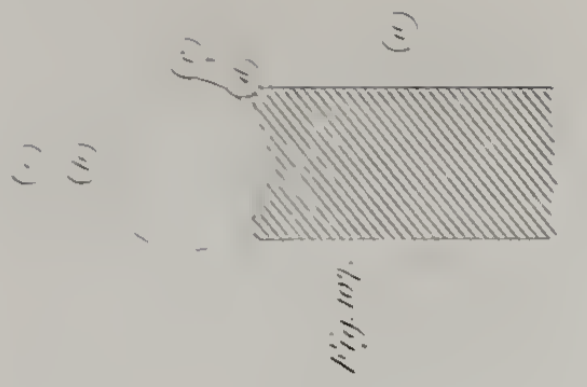
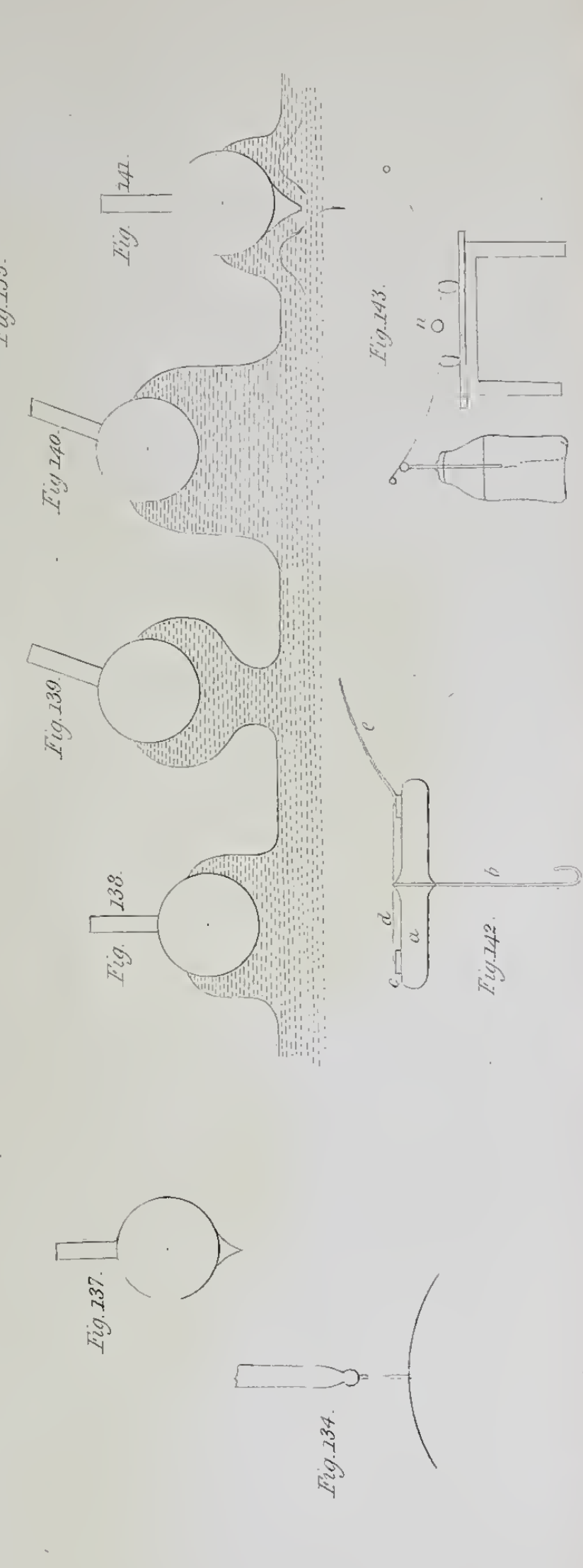
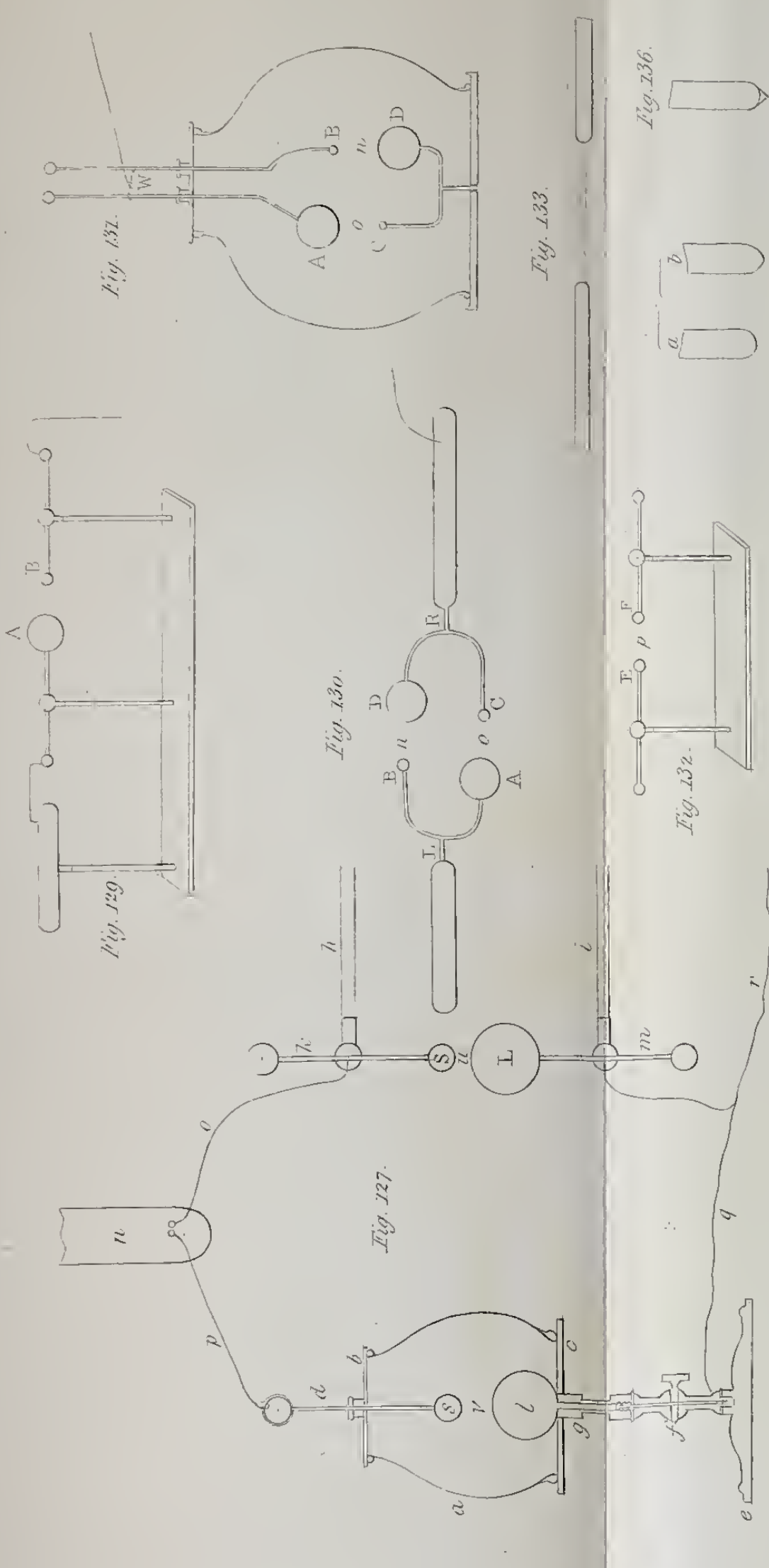
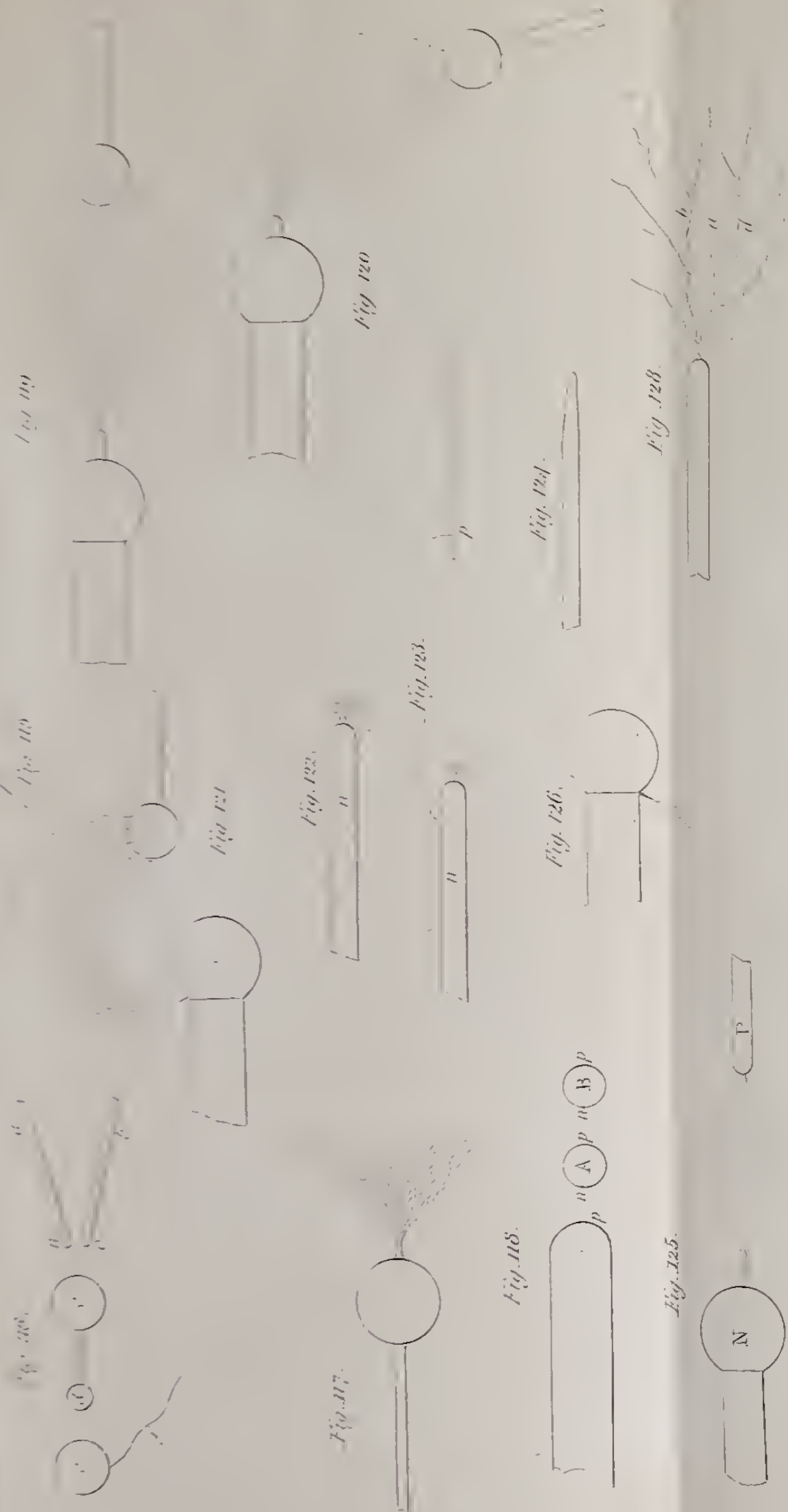

Fig. 103.









ICI PHARMACEUTICALS

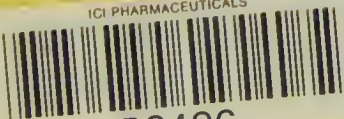

P8486

